



*Get organised™*

# WELCOME TO OUR WORLD

When you choose TengTools you immediately stand out from the crowd as an individual who is intent on achieving their goals.

TengTools offers hand tools in smart storage solutions for demanding professionals within the automotive, maintenance and engineering sectors as well as motor sport enthusiasts who aspire to use the same tools as top mechanics across the globe.

With close to 3,000 products in the wide range we cater for mechanics and craftsmen within industry, workshops, engineering and automotive sectors.

Success is born out of organisation. With the TengTools 'Get Organised' system you can build your ultimate tool kit in 3 simple steps. Choose your storage, choose your tool trays, click together.

*Get organised*<sup>™</sup>







#getorganised





# OUR HISTORY

OVER 35 YEARS EXPERIENCE

**1985**

Our founder Henri Tengvall saw the mechanics' need for a well selected range of hand tools and storage solutions that could work together to meet the demands of each individual. The TengTools name is derived from the Asian folk hero Teng. He was characterised by strength, courage and innovative thinking, properties that our brand has inherited.



**1993**

The introduction of the Mecca Rosso range of socket sets this year was our first step in redefining the socket set market. A heavy-duty PS material insert tray stored the tools, all tools had their own specific place in the set, recessed handles provided a comfortable grip and rubber feet prevented the set from sliding.



**1990**

We were ready to launch the TengTools brand to a global audience. Our debut at the Cologne Trade Show this year was the platform for this launch. Highlighting the quality of our tested and approved tools was the beginning of our expansion into different Markets. Following this show TengTools was launched in Sweden & Norway where we have been one of the leading brands ever since.

**1997**

This year we introduce the world to the idea of Get Organised! We launch the unique TengTools Tool Tray system that has become the core concept of the brand. Each tool set is supplied in a unique tool tray that can be clicked together with any other TengTools tray to fit neatly into your chosen tool storage solution. Build Your Ultimate Tool Kit to suit your exact needs.



**2004**

The Mega Master is born! The launch of the iconic 1,001 piece tool kit supplied in a full storage stack system comprising of a 10-drawer roller cabinet, a 3 drawer middle box and the 6 drawer top box with the TengTools eyes making any lucky owner of this kit stand out from the crowd. It has become the biggest selling tool kit in the range.



**2019**

Innovating and designing new products from our HQ in Sweden with Typically Teng features that you have come to expect. Anti-slip spanners, P Series torque wrenches, work benches and workshop racking all added to the range.



**2009**

After growing to be available in over 30 countries around the world we are now synonymous with being one of the pioneers of tool organisation. This year we push the boundaries further than before with the launch of the EVA Tool Storage solution. The EVA foam is cut to fit the exact shape of each tool. When a tool is removed its place in the set is clearly visible in red and the soft foam protects the tools. The ultimate choice in tool organisation.

**2021**

We have agreed a partnership, with two time FIA Formula E World Championship winners, DS Techeetah. This agreement continues our ongoing support in motor sport. We are the preferred choice of tools for many Speedway and Motor Sport mechanics who know wasting time searching for tools is not an option!

# MAKE THE PROFESSIONAL CHOICE

Every tool in this catalogue has been developed to help you work more efficiently. Our product development team have created 'Typically Teng' features on many products that have repeatedly earned us top ratings for value and performance and numerous recommendations in the trade and consumer press.

'Typically Teng' features will help you work better, smarter and faster. Features that include a unique tool storage system 'Get Organised', ratchets with quick release and flip reverse, ISO certified torque wrenches with in-built angular gauges, screwdrivers with T drive, hardened tips and ergonomically designed handles, 'Mega Bite' pliers with titanium coated joints and spanners with the 'Hip Grip' drive system for increased torque.

Our continuous development and quality improvement programmes have secured TengTools position as one of the market leaders in markets around the world







Get organised™

# STAND OUT FROM THE CROWD

TengTools has become the first choice for many industrial users all over the world. Our unique 'Get Organised' system allows professionals to build a custom tool kit to suit their own individual needs.

Professionals in many industries may require tools to be stored in EVA foam. We have an extensive range of EVA tool trays that can be used with our clever storage options to create a bespoke tool kit ready for the demands of any workshop.

TengTools has been used in the toughest environments around the world and is built to last. We offer a complete solution of high quality tools at a reasonable price.

Our tools are used by companies that do not compromise on quality. Our extensive range offers an opportunity for buyers to find an optimal assortment with regard to quality, range and price.







The cabinets are easy to organise,  
they are at the right price level  
and the quality is great, even for  
our needs! We need tools that we  
can trust and rely on.

Get organised™

# WORKING WITH WINNERS

TengTools users stand out from the crowd as individuals who are on the road to achieving their goals!

We have become synonymous with Speedway and Rallycross as well as supporting other motor sports & events around the world.

Our tools have become the only choice for many professional mechanics working in motor sport where wasting time searching for tools is not an option.

With our vast experience working with motor sport mechanics we know that tools needs to be easily adaptable to their needs. Our 'Get Organised' system is perfect for creating tool kits to suit the requirements of each technician allowing them to perform at their best every day.



















We don't have time to waste, we need our tools to be ready when we need them. Everything has a specific place. The tool kits look damn good too!



Get organised™

<b>TOOL KITS</b>		<b>14</b>
	Stacks	16
	Roller Cabinets	40
	Top Boxes	54
	Service Cases	58
	Racking	69
<b>TOOL STORAGE</b>		<b>78</b>
	Stacks	80
	Top Boxes	83
	Middle Boxes	86
	Roller Cabinets	87
	Side Cabinets	95
	Racking	106
<b>GET ORGANISED</b>		<b>118</b>
	PS Trays	122
	EVA Trays	162
	Wall Racks	187
<b>SOCKET SETS</b>		<b>192</b>
	1/4" Drive	194
	3/8" Drive	200
	1/2" Drive	208
	3/4" Drive	216
	1" Drive	218
	Mixed Drive Sets	218
	Impact	221
	Impact	221
<b>SOCKETS &amp; ACCESSORIES</b>		<b>226</b>
	Ratchets	228
	Accessories	231
	Impact Accessories	236
	1/4" Drive Sockets	237
	3/8" Drive Sockets	242
	1/2" Drive Sockets	248
	3/4" Drive Sockets	254
	1" Drive Sockets	255
Impact Sockets	258	
<b>TORQUE TOOLS</b>		<b>270</b>
	1/4" Drive	272
	3/8" Drive	273
	1/2" Drive	274
	3/4" Drive	276
	Insert Tools	277
	Accessories	279

<b>SPANNERS &amp; WRENCHES</b>		<b>284</b>
	Combination	286
	Ratchet	296
	Double Ring	301
	Double Open	305
	Wrenches	307
	Adjustable Wrenches	314
	<b>SCREWDRIVERS</b>	
	Mini Screwdrivers	318
	Loose Screwdrivers	322
	Double Ended Blades	325
	Power Through	326
	Nut Drivers	327
	Screwdriver Sets	328
	<b>BITS &amp; DRIVERS</b>	
	Individual Bits	336
	Adaptors & Extensions	344
	Bits Sets	345
	Bits Drivers	351
	Impact Bits	356
<b>HEX &amp; TX KEYS</b>		<b>360</b>
	Hex Keys	362
	TX Keys	371
<b>PLIERS</b>		<b>376</b>
	Cutters	378
	Combination Pliers	383
	Water Pump Pliers	385
	Pipe Wrenches	389
	Circlip Pliers	392
	Power Grip Pliers	396
	<b>INSULATED TOOLS</b>	
	Screwdrivers	404
	Pliers	409
<b>CUTTING TOOLS</b>		<b>412</b>
	Tin Snips	414
	Saws	416
	Knives	417
	Drill Bits	420
	Taps & Dies	422
	Files	424

# QUICK GUIDE

<b>MEASURING TOOLS</b>		<b>427</b>
	Calipers	428
	Feeler Gauges & Rules	429
	Squares	430
	Measuring Tapes	432
	Spirit Levels	433
<b>AUTO TOOLS</b>		<b>434</b>
	Hooks	436
	Hose Tools	438
	Engine Tools	439
	Wheel Tools	444
	Body Tools	446
<b>SERVICE TOOLS</b>		<b>448</b>
	Pullers	450
	Extractors	452
	Pry Bars	455
	Crimping/Wire Stripping Tools	456
	Voltage Testers	458
	Pipe Cutters	459
	Rivet Tools	462
	Inspection Tools	465
	Lighting	467
	Workshop	468
	Clamping Tools	471
	Striking Tools	473
	Fall Protection	477
	Safety Glasses	479
<b>AIR TOOLS</b>		<b>482</b>
	Ratchets	484
	Impact Wrenches	485
	Drills	489
	Cutting & Grinding	490
	Needle Scaler / Rivet Gun	494
	Blow Guns	495
<b>INDEX</b>		<b>496</b>
	Alphabetic Index	496
	Alphanumeric Index	503
	Notes	524



<b>Tool Kits</b>	
<b>Tool Storage</b>	
<b>Get Organised System</b>	
<b>Socket Sets</b>	
<b>Sockets &amp; Accessories</b>	
<b>Torque Tools</b>	
<b>Spanners &amp; Wrenches</b>	
<b>Screwdrivers</b>	
<b>Bits &amp; Drivers</b>	
<b>Hex &amp; TX Keys</b>	
<b>Pliers</b>	
<b>Insulated Tools</b>	
<b>Cutting Tools</b>	
<b>Measuring Tools</b>	
<b>Auto Tools</b>	
<b>Service Tools</b>	
<b>Air Tools</b>	

# TOOL KITS

**BETTER TOOLS** BRING BETTER RESULTS

When you are working on your vehicle you take pride in what you are doing. You want the best. When you choose Teng Tools you immediately stand out from the crowd as an individual who is ready to succeed.

Each tool kit has been compiled with the help of technicians from various trades



TOOL KITS AVAILABLE IN:

**STACKS**



**CABINETS**



**TOP BOXES**



**PORTABLE**



**WORKSHOP**







GET ORGANISED

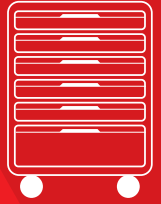

All tools are supplied in our unique Get Organised tool tray system. Every tool has it's own place in each kit



A range of tool kits are available in PS Trays for a cost effective storage solution



EVA foam tool kits are ideal for industrial settings where it is essential to store tools in a secure organised manner and to know what tool is missing at a glance



Tool kits are available in many shapes and sizes. There is a kit to fit your exact needs



Tool kits with worktop surfaces are also available creating portable workstations





## MONSTER MEGA MASTER TOOL KIT

1100 Pieces

- A complete tool kit covering the majority of the requirements of most types of user
- Includes a 1/2" drive composite air gun together with a wide range of impact sockets
- All the tools are laid out in individual tool trays using the TengTools Get Organised system
- Easy to see if any tools have been mislaid or lost helping to prevent leaving them with the work piece
- Supplied in the TengTools double width TC810N 10 drawer top box and the TCW809N 9 drawer 53" wide roller cabinet

Item ID: TCMONSTER01

317 kg



- 19 Drawer
- 53" Wide Cabinet
- Heavy Gauge Steel
- 5-Step Rust Protection
- Comfort Grip Handle
- 6" Castor Wheels with Brakes
- 3 Step Ball Bearing Slides
- Combination Lock

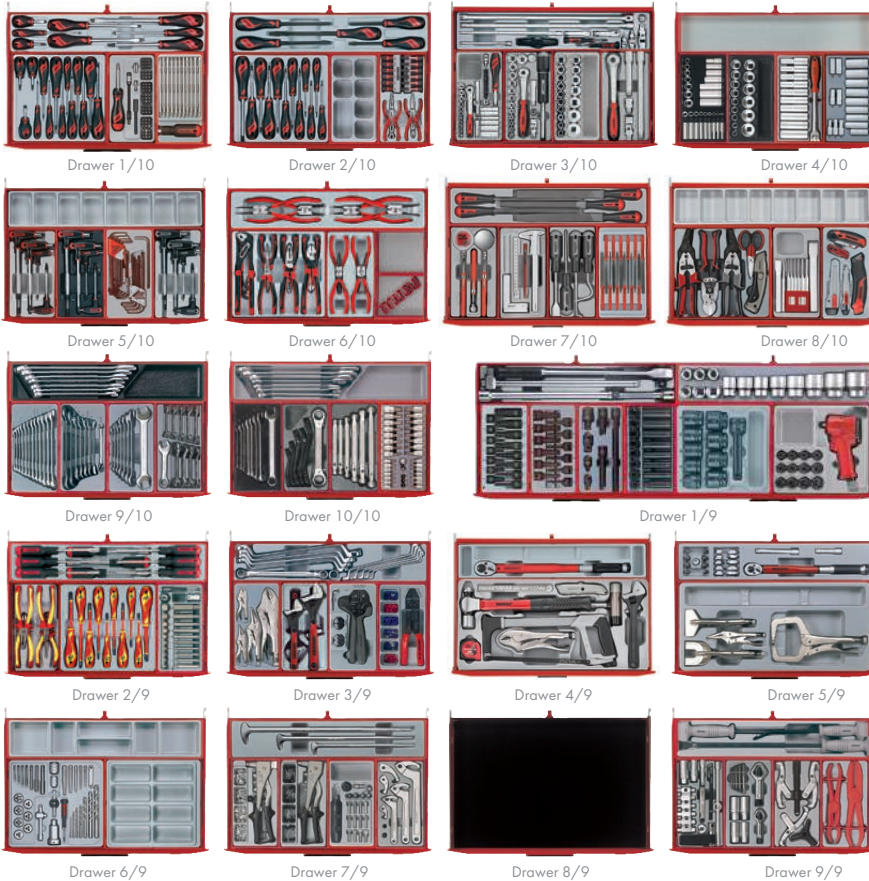

Continued



Contents:		
Drawer Number	Item ID	Description
Storage 	TC810N	Extra Wide Top Box - 10 Drawer
	TCW809N	Extra wide tool cabinet - 9 Drawer
1/10	TTD914N	14 piece screwdriver set
1/10	TTMD74	74 piece ratcheting bits driver set
1/10	TTMD12D	12 piece screwdriver set
1/10	TTX918N	8 piece screwdriver set
2/10	TTD912TXN	12 piece TX driver set
2/10	TTMI16	16 piece mini tool set
2/10	TT01	Add on tool tray
2/10	TTXMDTN	5 piece power thru screwdriver set
3/10	TT1435	35 piece 1/4" drive socket set
3/10	TT3819	19 piece 3/8" drive socket set
3/10	TT1205	5 piece 1/2" drive socket accessory set
3/10	TT1217	17 piece 1/2" drive socket set
3/10	TTXEXT13	13 piece extension bar set
4/10	TTAF32	32 piece 1/4" and 3/8" drive AF socket set
4/10	TT1215AF	15 piece 1/2" drive AF socket set
4/10	TT1211	11 piece 1/2" drive deep socket set
4/10	TT3816	16 piece 3/8" drive deep socket set
4/10	TTX00	Add on tool tray
5/10	TTHX7	7 piece T handle hex driver set
5/10	TTHX7AF	7 piece T handle AF hex driver set
5/10	TTHT28	28 piece hex and TX key set
5/10	TTTX7	7 piece T handle TX key set
5/10	TTX03	Add on tool tray
6/10	TTD441-T	8 piece plier set
6/10	TT474-7	4 piece 7" circlip plier set
6/10	TT00	Add on tool tray
6/10	TTX474-9	4 piece 9" circlip plier set
7/10	TTTM03	3 piece inspection tool set
7/10	TTBM	4 piece measuring tool set
7/10	TTSR04	4 piece scraper and removal tool set
7/10	TTNF12	12 piece needle file set
7/10	TTXF05	5 piece file set
8/10	TTDCT05	5 piece cutting tool set
8/10	TTK40	40 piece knife set
8/10	TTPC09	9 piece punch and chisel set
8/10	TTX03	Add on tool tray
9/10	TT1236	12 piece combination spanner set
9/10	TT6508R	8 piece ratcheting combination spanner set
9/10	TT6208	8 piece double open ended spanner set
9/10	TT6010M	10 piece midget combination spanners
9/10	TTX2032	7 piece combination spanner set

Contents:		
Drawer Number	Item ID	Description
10/10	TTX2640	7 piece combination spanner set
10/10	TT3592	8 piece AF combination spanner set
10/10	TTR0R5	6 piece RORS wrench set
10/10	TT6506	6 piece double flex wrench set
10/10	TTBS35	35 piece bits set
1/9	TT9015HX	15 piece impact hex bit socket set
1/9	TT9212TX	12 piece impact TX bit set
1/9	TT9207	7 piece impact accessory set
1/9	TT9116N	16 piece 1/2" drive impact socket set
1/9	TTX3404	4 piece 3/4" drive socket accessory set
1/9	TTD9416	16 piece 3/4" drive impact socket set
1/9	TTX3414	14 piece 3/4" drive socket set
1/9	TTDAWM13M	13 Pieces Air Impact Wrench Set
2/9	TTV440	4 piece 1000V insulated plier set
2/9	TTDV910N	10 piece 1000V insulated screwdriver set
2/9	TTHX23	23 piece 1/2" drive hex bit socket set
2/9	TTXMDN	9 piece nut driver set
3/9	TTVG05	5 piece power grip plier set
3/9	TTADJ04	4 piece adjustable wrench set
3/9	TTCP121	121 piece crimping plier set
3/9	TTCP04	4 piece ratchet crimping plier set
3/9	TTX6311	11 piece double ring spanner set
4/9	TTPS09	9 piece general tool kit
4/9	TTX1292	1/2" drive angular gauge torque wrench
5/9	TTSPSG	4 Power grip pliers
5/9	TTX3892	3/8" drive torque wrench set
6/9	TTDTD34	34 piece tap and die rethreading set
6/9	TTD01	Add on tool tray
6/9	TTX01	Add on tool tray
7/9	TTNR81	81 piece Nutsert gun set
7/9	TTHR81	81 piece Rivet gun set
7/9	TTID20	20 piece impact driver set
7/9	TTHP08	8 piece hook and pin wrench set
7/9	TTXPB3	3 piece roll/heel bar set
9/9	TTOS16	16 piece oil service kit
9/9	TTSN11	11 piece extractor set
9/9	TT804	4 piece puller set
9/9	TTHC03	3 piece hose clamp set
9/9	TTXPB3A	3 piece pry bar set

Item ID: TCMONSTER01





## MONSTER MEGA MASTER TOOL KIT

1185 Pieces

- A complete tool kit covering the majority of the requirements of most types of user
- All the tools are laid out in individual tool trays using the TengTools Get Organised system
- Easy to see if any tools have been mislaid or lost helping to prevent leaving them with the work piece
- Supplied in the TengTools double width TC810N 10 drawer top box and the TCW809N 9 drawer 53" wide roller cabinet

Item ID: TCMONSTER02

318.5 kg



- 19 Drawer
- 53" Wide Cabinet
- Heavy Gauge Steel
- 5-Step Rust Protection
- Comfort Grip Handle
- 6" Castor Wheels with Brakes
- 3 Step Ball Bearing Slides
- Combination Lock



Drawer 1/10



Drawer 2/10



Drawer 3/10



Drawer 4/10



Drawer 5/10



Drawer 6/10



Drawer 7/10



Drawer 8/10



Drawer 9/10



Drawer 10/10



Drawer 1/9



Drawer 2/9



Drawer 3/9



Drawer 4/9



Drawer 5/9



Drawer 6/9

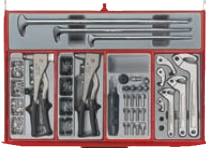

Drawer 7/9



Drawer 8/9

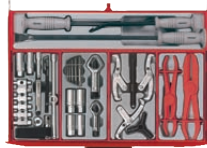

Drawer 9/9

Continued





Contents:		
Drawer Number	Item ID	Description
Storage 	TC810N	Extra Wide Top Box - 10 Drawer
	TCW809N	Extra wide tool cabinet - 9 Drawer
1/10	TTD914N	14 piece screwdriver set
1/10	TTMD74	74 piece ratcheting bits driver set
1/10	TTMD12D	12 piece screwdriver set
1/10	TTX918N	8 piece screwdriver set
2/10	TTD912TXN	12 piece TX driver set
2/10	TTMI16	16 piece mini tool set
2/10	TT01	Add on tool tray
2/10	TTXMDTN	5 piece power thru screwdriver set
3/10	TT1435	35 piece 1/4" drive socket set
3/10	TT3819	19 piece 3/8" drive socket set
3/10	TT1205	5 piece 1/2" drive socket accessory set
3/10	TT1217	17 piece 1/2" drive socket set
3/10	TTXEXT13	13 piece extension bar set
4/10	TTAF32	32 piece 1/4" and 3/8" drive AF socket set
4/10	TT1215AF	15 piece 1/2" drive AF socket set
4/10	TT1211	11 piece 1/2" drive deep socket set
4/10	TT3816	16 piece 3/8" drive deep socket set
4/10	TTX00	Add on tool tray
5/10	TTHX7	7 piece T handle hex driver set
5/10	TTHX7AF	7 piece T handle AF hex driver set
5/10	TTHT28	28 piece hex and TX key set
5/10	TTTX7	7 piece T handle TX key set
5/10	TTX03	Add on tool tray
6/10	TTD441-T	8 piece plier set
6/10	TT474-7	4 piece 7" circlip plier set
6/10	TT00	Add on tool tray
6/10	TTX474-9	4 piece 9" circlip plier set
7/10	TTTM03	3 piece inspection tool set
7/10	TTBM	4 piece measuring tool set
7/10	TTSR04	4 piece scraper and removal tool set
7/10	TTNF12	12 piece needle file set
7/10	TTXF05	5 piece file set
8/10	TTDCT05	5 piece cutting tool set
8/10	TTK40	40 piece knife set
8/10	TTPC09	9 piece punch and chisel set
8/10	TTX03	Add on tool tray
9/10	TTX2640	7 piece combination spanner set
9/10	TT3592	8 piece AF combination spanner set
9/10	TTRORS	6 piece RORS wrench set
9/10	TT6506	6 piece double flex wrench set
9/10	TTBS35	35 piece bits set

Contents:		
Drawer Number	Item ID	Description
10/10	TT1236	12 piece combination spanner set
10/10	TT6508R	8 piece ratcheting combination spanner set
10/10	TT6208	8 piece double open ended spanner set
10/10	TT6010M	10 piece midget combination spanners
10/10	TTX2032	7 piece combination spanner set
1/9	TTBE18	18 piece stud extractor set
1/9	TT9015HX	15 piece impact hex bit socket set
1/9	TT9024	24 piece 1/4" and 3/8" drive impact socket set
1/9	TT9212TX	12 piece impact TX bit set
1/9	TT9207	7 piece impact accessory set
1/9	TT9116N	16 piece 1/2" drive impact socket set
1/9	TTX3404	4 piece 3/4" drive socket accessory set
1/9	TTD9416	16 piece 3/4" drive impact socket set
1/9	TTX3414	14 piece 3/4" drive socket set
2/9	TTV440	4 piece 1000V insulated plier set
2/9	TTD910N	10 piece 1000V insulated screwdriver set
2/9	TTHX23	23 piece 1/2" drive hex bit socket set
2/9	TTXMDN	9 piece nut driver set
3/9	TTVG05	5 piece power grip plier set
3/9	TTADJ04	4 piece adjustable wrench set
3/9	TTCP121	121 piece crimping plier set
3/9	TTCP04	4 piece ratchet crimping plier set
3/9	TTX6311	11 piece double ring spanner set
4/9	TTPS09	9 piece general tool kit
4/9	TTX1292	1/2" drive angular gauge torque wrench
5/9	TTSPG	4 Power grip pliers
5/9	TTX3892	3/8" drive torque wrench set
6/9	TTD1D34	34 piece tap and die rethreading set
6/9	TTX01	Add on tool tray
6/9	TTD01	Add on tool tray
7/9	TTNR81	81 piece Nutsert gun set
7/9	TTHR81	81 piece Rivet gun set
7/9	TTD20	20 piece impact driver set
7/9	TTHP08	8 piece hook and pin wrench set
7/9	TTXPB3	3 piece roll/heel bar set
9/9	TTOS16	16 piece oil service kit
9/9	TTSN11	11 piece extractor set
9/9	TT804	4 piece puller set
9/9	TTHC03	3 piece hose clamp set
9/9	TTXPB3A	3 piece pry bar set
9/9	TTHC03	3 piece hose clamp set
9/9	TTXPB3A	3 piece pry bar set

Item ID: TCMONSTER02



## MEGA MASTER TOOL KIT

1001 Pieces

- A complete tool kit covering the requirements of most types of user
- All the tools are laid out in individual tool trays using the TengTools Get Organised system
- Easy to see if any tools have been mislaid or lost helping to prevent leaving them with the work piece
- Supplied in a red TengTools 19 drawer stack system with a top box, middle box and roller cabinet
- Distinctive TengTools eyes logo on the drop front of the top box

Item ID: TCMM1001N

220 kg



- 19 **Drawer**
- Heavy Gauge Steel**
- 5-Step Rust Protection**
- Comfort Grip Handle**
- 5" Castor Wheels with Brakes**
- 3 Step Ball Bearing Slides**
- Combination Lock**

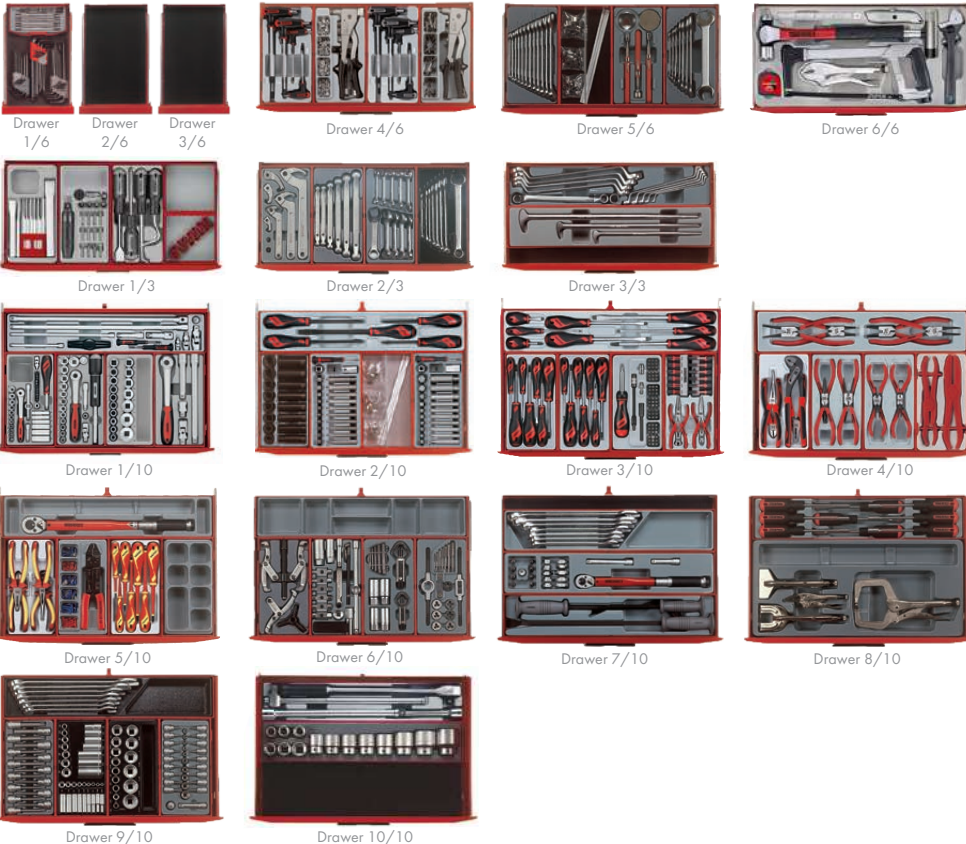

Continued



Contents:		
Drawer Number	Item ID	Description
Storage 	TC806NF	Tool Box Top Box 6 Drawer
	TC803N	Tool Box Middle Box 3 Drawer
	TCW810N	Tool Box Roller Cabinet 10 Drawer
1/6	TM708	8 piece mini screwdriver set
1/6	I479MM	9 piece ball point hex key wrench set
1/6	I479AF	9 piece AF ball point hex key wrench set
1/6	I479TX	9 piece TX wrench set
4/6	TTHX7	7 piece T handle hex driver set
4/6	TTNR81	81 piece Nutsert rivet set
4/6	TTTX7	7 piece T handle TX/TPX driver set
4/6	TTHR81	81 piece Rivet gun set
5/6	TTI236	12 piece metric combination spanner set
5/6	TTALU	32 piece socket clip rail set
5/6	TTMO3	3 piece inspection tool set
5/6	TT6208	8 piece open ended spanner set
6/6	TTPS09	9 piece general tool kit with PS tray
1/3	TTPC09	9 piece punch and chisel set
1/3	TTID20	20 piece 1/2" drive impact driver set
1/3	TTSR04	4 piece scraper and remover set
1/3	TT00	Add on tool tray
2/3	TTHP08	8 piece hook and pin wrench set
2/3	TT6506	6 piece double flex wrench set
2/3	TT6010M	10 piece midget combination spanner set
2/3	TT3592	8 piece AF combination spanner set
3/3	TTXPB3	3 piece roll/heel bar set
3/3	TTX6311	11 piece metric double ring spanner set
1/10	TTXEXT13	13 piece extension set
1/10	TTI205	5 piece 1/2" drive socket accessories set
1/10	TTI435	35 piece 1/4" drive regular/deep metric socket set
1/10	TT3819	19 piece 3/8" drive metric socket set
1/10	TT1217	17 piece 1/2" drive regular metric socket set
2/10	TTTX23	23 piece 40/70mm TX bit socket set
2/10	TTHX23	23 piece metric hex bit socket set
2/10	TTALU	32 piece socket clip rail set
2/10	TTXMDTN	5 piece power thru screwdriver set
2/10	TT9116N	16 piece 1/2" drive regular/deep impact socket set

Contents:		
Drawer Number	Item ID	Description
3/10	TTX918N	8 piece Mega Drive screwdriver set
3/10	TT917N	7 piece Mega Drive screwdriver set
3/10	TT917TXN	7 piece TX/TPX Mega Drive screwdriver set
3/10	TTMD74	74 piece ratcheting bits driver set
3/10	TTMI16	16 piece mini plier/screwdriver set
4/10	TTX474-9	4 piece 9" circlip plier set
4/10	TT440-T	4 piece Mega Bite plier set
4/10	TT474-7	4 piece 7" circlip plier set
4/10	TT474-5	4 piece 5" circlip plier set
4/10	TTHC03	3 piece hose clamp set
5/10	TTX1292	1/2" drive torque wrench
5/10	TTV440	4 piece 1000V insulated plier set
5/10	TTCP121	121 piece crimping tool set
5/10	TTV907N	7 piece 1000V screwdriver set
5/10	TT01	Add on tool tray with dividers
6/10	TTX01	Add on tool tray with dividers
6/10	TT804	2 in 1 puller set
6/10	TTOS16	16 piece oil service set
6/10	TTSM11	11 piece stud and nut remover set
6/10	TTD17	17 piece tap and die set
7/10	TTX2032	7 piece metric combination spanner set
7/10	TTX3892	22 piece 3/8" drive torque wrench set
7/10	TTXPB3A	3 piece pry bar set
8/10	TTXMDN	9 piece nut driver set
8/10	TTPSPG	4 piece power grip pliers set
9/10	TTX2640	7 piece AF combination spanner set
9/10	TTXH15	15 piece 1/2" drive long bits socket set
9/10	TTI215AF	15 piece 1/2" drive AF regular socket set
9/10	TTAF32	32 piece 1/4" and 3/8" drive regular/deep AF socket set
9/10	TTX30	30 piece 1/4" and 3/8" drive TX, TPX and TX-E socket set
10/10	TTX3404	4 piece 3/4" drive socket accessories set
10/10	TTX3414	14 piece 3/4" drive metric socket set
-	ABS-TOP	ABS top for roller cabinet
-	580	Magnetic Bits tray

Item ID: **TCMM1001N**



## MEGA MASTER TOOL KIT

1001 Pieces

- 1,001 piece Mega Master tool kit
- A complete tool kit covering the requirements of most types of user
- All the tools are laid out in individual tool trays using the TengTools Get Organised system
- Easy to see if any tools have been mislaid or lost helping to prevent leaving them with the work piece
- Supplied in a black TengTools 19 drawer stack system with a top box, middle box and roller cabinet all finished in a high gloss black 220 kg



ITEM ID:	Description
TCMM1001BK	Black Tool Kit with TengTools Logo sticker

- 19 Drawer**
- Heavy Gauge Steel**
- 5-Step Rust Protection**
- Comfort Grip Handle**
- 5" Castor Wheels with Brakes**
- 3 Step Ball Bearing Slides**
- Combination Lock**



Drawer 1/6



Drawer 2/6

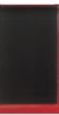

Drawer 3/6



Drawer 4/6



Drawer 5/6



Drawer 6/6



Drawer 1/3



Drawer 2/3



Drawer 3/3



Drawer 1/10



Drawer 2/10



Drawer 3/10



Drawer 4/10



Drawer 5/10



Drawer 6/10



Drawer 7/10



Drawer 8/10



Drawer 9/10



Drawer 10/10

Continued



Contents:		
Drawer Number	Item ID	Description
Storage 	TC806NBK	Tool Box Top Box 6 Drawer Black
	TC803NBK	Tool Box Middle Box Black 3 Drawer
	TCW810NBK	Tool Box Roller Cab 6 Drawer Black
1/6	TM708	8 piece mini screwdriver set
1/6	I479MM	9 piece ball point hex key wrench set
1/6	I479AF	9 piece AF ball point hex key wrench set
1/6	I479TX	9 piece TX wrench set
4/6	TTHX7	7 piece T handle hex driver set
4/6	TTNR81	81 piece Nutsert rivet set
4/6	TTTX7	7 piece T handle TX/TPX driver set
4/6	TTHR81	81 piece Rivet gun set
5/6	TTI236	12 piece metric combination spanner set
5/6	TTALU	32 piece socket clip rail set
5/6	TTMO3	3 piece inspection tool set
5/6	TT6208	8 piece open ended spanner set
6/6	TTPS09	9 piece general tool kit with PS tray
1/3	TTPC09	9 piece punch and chisel set
1/3	TTID20	20 piece 1/2" drive impact driver set
1/3	TTSR04	4 piece scraper and remover set
1/3	TT00	Add on tool tray
2/3	TTHP08	8 piece hook and pin wrench set
2/3	TT6506	6 piece double flex wrench set
2/3	TT6010M	10 piece midget combination spanner set
2/3	TT3592	8 piece AF combination spanner set
3/3	TTXPB3	3 piece roll/heel bar set
3/3	TTX6311	11 piece metric double ring spanner set
1/10	TTXEXT13	13 piece extension set
1/10	TTI205	5 piece 1/2" drive socket accessories set
1/10	TTI435	35 piece 1/4" drive regular/deep metric socket set
1/10	TT3819	19 piece 3/8" drive metric socket set
1/10	TTI217	17 piece 1/2" drive regular metric socket set
2/10	TTTX23	23 piece 40/70mm TX bit socket set
2/10	TTHX23	23 piece metric hex bit socket set
2/10	TTALU	32 piece socket clip rail set
2/10	TTXMDTN	5 piece power thru screwdriver set
2/10	TT9116N	16 piece 1/2" drive regular/deep impact socket set
3/10	TTX918N	8 piece Mega Drive screwdriver set
3/10	TT917N	7 piece Mega Drive screwdriver set
3/10	TT917TXN	7 piece TX/TPX Mega Drive screwdriver set
3/10	TTMD74	74 piece ratcheting bits driver set
3/10	TTM16	16 piece mini plier/screwdriver set

Contents:		
Drawer Number	Item ID	Description
4/10	TTX474-9	4 piece 9" circlip plier set
4/10	TT440-T	4 piece Mega Bite plier set
4/10	TT474-7	4 piece 7" circlip plier set
4/10	TT474-5	4 piece 5" circlip plier set
4/10	TTHC03	3 piece hose clamp set
5/10	TTX1292	1/2" drive torque wrench
5/10	TTV440	4 piece 1000V insulated plier set
5/10	TTCP121	121 piece crimping tool set
5/10	TTV907N	7 piece 1000V screwdriver set
5/10	TT01	Add on tool tray with dividers
6/10	TTX01	Add on tool tray with dividers
6/10	TT804	2 in 1 puller set
6/10	TTOS16	16 piece oil service set
6/10	TTSM11	11 piece stud and nut remover set
6/10	TTTD17	17 piece tap and die set
7/10	TTX2032	7 piece metric combination spanner set
7/10	TTX3892	22 piece 3/8" drive torque wrench set
7/10	TTXPB3A	3 piece pry bar set
8/10	TTXMDN	9 piece nut driver set
8/10	TTPSPG	4 piece power grip pliers set
9/10	TTX2640	7 piece AF combination spanner set
9/10	TTTXH15	15 piece 1/2" drive long bits socket set
9/10	TTI215AF	15 piece 1/2" drive AF regular socket set
9/10	TTAF32	1/4 And 3/8 Inch Drive AF socket set
9/10	TTTX30	30 piece 1/4" and 3/8" drive TX, TPX and TX-E set
10/10	TTX3404	4 piece 3/4" drive socket accessories set
10/10	TTX3414	14 piece 3/4" drive metric socket set
-	ABS-TOP	ABS top for roller cabinet
-	580	Magnetic Bits tray

ITEM ID:	Description
TCMM1001BK	Black Tool Kit with TengTools Logo sticker

### Personalised Tool Box Sticker

This is now available to you through your local stockist. Send us the image that you would like to use and we will customise your tool kit for you. Images need to be supplied as high resolution jpeg, eps, PDF, or ai vector format.

\* Subject to artwork being supplied in the correct format.







**STACK SYSTEM TOOL KIT**

1055 Pieces

- A complete tool kit covering the requirements of most types of user
- All the tools are laid out in individual tool trays using the TengTools Get Organised system
- Easy to see if any tools have been mislaid or lost helping to prevent leaving them with the work piece
- Supplied in a red TengTools 16 drawer stack system with a top box, middle box and roller cabinet with the distinctive TengTools eyes logo on the drop front of the top box

Item ID: TCMM1055N

170.3 kg



- 16 Drawer**
- Heavy Gauge Steel**
- 5-Step Rust Protection**
- Comfort Grip Handle**
- 5" Castor Wheels with Brakes**
- 3 Step Ball Bearing Slides**
- Combination Lock**



Drawer 1/6    Drawer 2/6    Drawer 3/6



Drawer 4/6



Drawer 5/6



Drawer 6/6



Drawer 1/3



Drawer 2/3



Drawer 3/3



Drawer 1/7



Drawer 2/7



Drawer 3/7



Drawer 4/7



Drawer 5/7



Drawer 6/7



Drawer 7/7



Side Panel

Continued



Contents:		
Drawer Number	Item ID	Description
Storage 	TC806NF	Tool Box Top Box 6 Drawer
	TC803N	Tool Box Middle Box 3 Drawer
	TCW807N	Tool Box Roller Cabinet 7 Drawer
	TCW-SP01	Tool Box Roller Cabinet Side Panel
	TCW-HK10	Mixed Hooks 10Pcs
2/6	1476NTX1	8 piece fold up ball point TX key set
2/6	1477NX	8 piece fold up screwdriver key set
2/6	587H	Magnifying glass with LED light
4/6	TT1435	35 piece 1/4" drive regular/deep metric socket set
4/6	TT3819	19 piece 3/8" drive metric socket set
4/6	TT1218	18 piece 1/2" drive metric socket set
4/6	TT1211	11 piece 1/2" drive deep metric socket set
5/6	TT1236	12 piece metric combination spanner set
5/6	TT6010M	10 piece midget combination spanner set
5/6	TT6508RS	8 piece metric ratchet combination spanner set
5/6	TTADJ04	4 piece adjustable wrench set
6/6	TTHX7	7 piece metric T handle hex key set
6/6	TTTX7	7 piece T handle TX driver set
6/6	TTHT28	28 piece hex and TX key set
6/6	TT804	4 piece puller set
1/3	TTD441-T	8 piece plier set
1/3	TT474-7	4 piece 7" circlip plier set
1/3	TTM116	16 piece mini plier and screwdriver set
2/3	TTCP04	4 piece ratcheting crimping plier set
2/3	TTCP121	121 piece crimping tool set
2/3	TTV440	4 piece 1000 volt insulated plier set
2/3	TTV907N	7 piece 1000 volt insulated screwdriver set
3/3	TTTF10	10 piece flaring tool set
3/3	TTK40	40 piece knife set
3/3	TTDCT05	5 piece cutting tool set
1/7	TTD914N	14 piece screwdriver set
1/7	TT917TXN	7 piece TX driver set
1/7	TTMD74	74 piece ratcheting bits driver set
1/7	TTX918N	8 piece screwdriver set
2/7	TTHR81	81 piece Rivet gun set
2/7	TTNR81	81 piece Nutsert gun set
2/7	TTSD39	39 piece torque screwdriver set
2/7	TTBE18	18 piece stud extractor set

Contents:		
Drawer Number	Item ID	Description
2/7	TTX1292	1/2" drive torque wrench
3/7	TTVG05	5 piece power grip plier set
3/7	TTID20	20 piece impact driver set
3/7	TTPC09	9 piece punch and chisel set
3/7	TTNF12	12 piece needle file set
3/7	TTXEXT13	13 piece extension set
4/7	TTAF32	32 piece 1/4" and 3/8" drive AF socket set
4/7	TT1215AF	15 piece 1/2" drive AF socket set
4/7	TTBM	4 piece measuring tool set
4/7	TTTM08	8 piece inspection tool set
4/7	TTXTB09	9 piece 3/8" drive spark plug socket set
5/7	TTXHX15	15 piece 1/2" drive hex and TX socket set
5/7	TTTX30	30 piece TX, TPX and TXE socket set
5/7	TTRS15	15 piece 1/2" drive Ribe socket set
5/7	TTBS35	35 piece 1/4" and 3/8" drive bit socket set
5/7	TTX2032	7 piece metric combination spanner set
6/7	TT9024	24 piece 1/4" and 3/8" drive impact socket set
6/7	TT9207	7 piece 3/8" and 1/2" drive impact accessory set
6/7	TT9116N	16 piece 1/2" drive metric impact socket set
6/7	TTTS08	8 piece 1/2" drive wheel nut set
6/7	TTXPB3	3 piece roll/heel bar set
7/7	583M	Magnetic wrist band
7/7	TM149	4 in 1 hook and pick set
7/7	9850	6-24 volt circuit tester
7/7	DB034	34 piece fully ground drill bit set
-	580	Magnetic bits tray

Item ID: **TCMM1055N**



**STACK SYSTEM TOOL KIT**

715 Pieces

- A complete tool kit covering the many of the requirements of most types of user
- The tools are laid out in individual tool trays using the TengTools Get Organised system
- Larger tools are fitted to the removable free standing side plate for easier storage and use
- Easy to see if any tools have been mislaid or lost helping to prevent leaving them with the work piece
- Supplied in a red TengTools 19 drawer stack system with a top box, middle box and roller cabinet with the distinctive TengTools eyes logo on the drop front of the top box
- A comprehensive selection of tools using 11 of the available 19 drawers ensuring that space is still available to add to the kit if needed

Item ID: TCMM715N

172.7 kg



- 19 Drawer**
- Heavy Gauge Steel**
- 5-Step Rust Protection**
- Comfort Grip Handle**
- 5" Castor Wheels with Brakes**
- 3 Step Ball Bearing Slides**
- Combination Lock**



Drawer 1/6    Drawer 2/6    Drawer 3/6



Drawer 4/6



Drawer 5/6



Drawer 6/6



Drawer 1/3



Drawer 2/3



Drawer 3/3



Drawer 1/10



Drawer 2/10



Drawer 3/10



Drawer 4/10

Continued





Drawer 5/10



Drawer 6/10



Drawer 7/10



Drawer 8/10



Drawer 9/10



Drawer 10/10



Side Panel

Contents:		
Drawer Number	Item ID	Description
Storage 	TC806NF	Tool Box Top Box 6 Drawer
	TC803N	Tool Box Middle Box 3 Drawer
	TCW810N	Tool Box Roller Cabinet 10 Drawer
	TCW-SP01	Tool Box Roller Cabinet Side Panel
	TCW-HK10	Mixed Hooks 10Pcs
4/6	TTM116	16 piece mini plier/screwdriver set
4/6	TTID20	20 piece 1/2" drive impact driver set
4/6	TTPC09	9 piece punch and chisel set
4/6	TT01	Add on tool tray with dividers
5/6	TT917N	7 piece Mega Drive screwdriver set
5/6	TT440-T	4 piece Mega Bite plier set
5/6	TT917TXN	7 piece TX/TPX Mega Drive screwdriver set
5/6	TTMD74	74 piece ratcheting bits driver set
6/6	TTPSPG	4 piece power grip pliers with PS tray
1/3	TT804	2 in 1 puller set
1/3	TTNR81	81 piece nut rivet set
1/3	TTTD17	17 piece metric tap and die set
1/3	TTHP08	8 piece hook and pin wrench set
2/3	TTHX7	7 piece T handle hex driver set
2/3	TT474-7	4 piece 7" circlip plier set
2/3	TTTX7	7 piece T handle TX/TPX driver set
2/3	TTHR81	81 piece Rivet gun set
3/3	TTX6311	11 piece mm double ring spanner set
3/3	TTXPB3	3 piece roll bar set

Contents:		
Drawer Number	Item ID	Description
1/10	TTXEXT13	13 piece extension set
1/10	TTI435	35 piece 1/4" drive regular/deep metric socket set
1/10	TT3819	19 piece 3/8" drive metric socket set
1/10	TTI217	17 piece 1/2" drive regular metric socket set
1/10	TTI205	5 piece 1/2" drive socket accessories set
2/10	TTX1292	1/2" drive torque wrench
2/10	TT9116N	16 piece 1/2" drive regular/deep impact socket set
2/10	TTHEX23	23 piece metric hex bit socket set
2/10	TTALU	32 piece socket clip rail set
2/10	TTTX23	23 piece 40/70mm TX bit socket set
7/10	TTX2032	7 piece metric combination spanner set
7/10	TTI236	12 piece metric combination spanner set
7/10	TTSN11	11 piece stud and nut remover set
7/10	TTOS16	16 piece oil service set
7/10	TTALU	32 piece socket clip rail set
8/10	TTX918N	8 piece Mega Drive screwdriver set
8/10	TTPS09	9 piece general tool kit with PS tray
9/10	TTX2640	7 piece AF combination spanner set
9/10	TT3592	8 piece AF combination spanner set
9/10	TTAF32	32 piece 1/4" and 3/8" drive AF socket set
9/10	TTI215AF	15 piece 1/2" drive AF regular socket set
9/10	TTTX30	30 piece 1/4" and 3/8" drive TX, TPX and TX-E set

Item ID: **TCMM715N**



## STACK SYSTEM TOOL KIT

600 Pieces

- A complete tool kit covering the many of the requirements of most types of user
- The tools are laid out in individual tool trays using the TengTools Get Organised system
- Larger tools are fitted to the removable free standing side plate for easier storage and use
- Easy to see if any tools have been mislaid or lost helping to prevent leaving them with the work piece
- Supplied in a red TengTools 16 drawer stack system with a top box, middle box and roller cabinet with the distinctive TengTools eyes logo on the drop front of the top box
- A comprehensive selection of tools using 11 of the available 16 drawers ensuring that space is still available to add to the kit if needed

Item ID: TCMM600

178.3 kg



- 16 Drawer
- Heavy Gauge Steel
- 5-Step Rust Protection
- Comfort Grip Handle
- 5" Castor Wheels with Brakes
- 3 Step Ball Bearing Slides
- Combination Lock



Drawer 1/6    Drawer 2/6    Drawer 3/6



Drawer 4/6



Drawer 5/6



Drawer 6/6



Drawer 1/3



Drawer 2/3



Drawer 3/3



Drawer 1/7



Drawer 2/7



Drawer 3/7



Drawer 4/7

Continued



Drawer 5/10



Drawer 6/10



Drawer 7/10



Side Panel

Contents:		
Drawer Number	Item ID	Description
Storage 	TC806NF	Tool Box Top Box 6 Drawer
	TC803N	Tool Box Middle Box 3 Drawer
	TCW807N	Tool Box Roller Cabinet 7 Drawer
	TCW-SP01	Tool Box Roller Cabinet Side Panel
	TCW-HK10	Mixed Hooks 10Pcs
4/6	TT1435	35 piece 1/4" drive regular/deep metric socket set
4/6	TT3819	19 piece 3/8" drive metric socket set
4/6	TT1217	17 piece 1/2" drive regular metric socket set
4/6	TT1205	5 piece 1/2" drive socket accessories set
5/6	TT1236	12 piece metric combination spanner set
5/6	TT917N	7 piece Mega Drive screwdriver set
5/6	TT440	4 piece Mega Bite plier set
5/6	TTALU	32 piece socket clip rail set
6/6	TTPS09	9 piece general tool kit with PS tray
1/3	TTXEXT13	13 piece extension set
1/3	TTX918N	8 piece Mega Drive screwdriver set
2/3	TTOS16	16 piece oil service set
2/3	TTM116	16 piece mini plier/screwdriver set
2/3	TTHEX7	7 piece T handle hex driver set
2/3	TTTX7	7 piece T handle TX/TPX driver set
3/3	TT474-7	4 piece 7" circlip plier set
3/3	TT917TXN	7 piece TX/TPX Mega Drive screwdriver set
3/3	TTHEX23	23 piece metric hex bit socket set
3/3	TTTX23	23 piece 40/70mm TX bit socket set
1/7	1201	Flex Handle 1/2 Inch Drive 17 Inch
1/7	1424	Hex Key Set AF 10 Piece Set
1/7	1425	Hex Key Set Mm 10 Piece Set
1/7	1487	TX Key Set 7 Piece Set
1/7	586	Light Flexible With Magnet
1/7	641011	Wrench Flare Nut 10 X 11Mm
1/7	641213	Wrench Flare Nut 12 X 13Mm
1/7	661416	Wrench Flare Nut 7/16In X 1/2In
1/7	705	Hacksaw With 6 Inch Blades

Contents:		
Drawer Number	Item ID	Description
1/7	9850	Circuit Tester
1/7	CALD150	Caliper Digital 150Mm
1/7	ID506	Impact Driver Set 6 Pieces
1/7	MB499-7T	Plier Wire Strippers 7 Inch Tpr Grip
1/7	MDS03N	Hose Clip Driver 6Mm/7Mm
1/7	SPBP20	Plier Spark Plug Boot Removal
1/7	TRC1012	Spark Plug Thread Cleaner
1/7	TRC1418	Thread Cleaner
1/7	TTX2032	7 piece metric combination spanner set
1/7	TT804	2 in 1 puller set
1/7	TTSN11	11 piece stud and nut remover set
2/7	TTX1292	1/2" drive torque wrench with flex handle
2/7	TTTD17	17 piece tap and die set
2/7	TTPC09	9 piece punch and chisel set
2/7	TTHR81	81 piece hand rivet set
2/7	TT9116N	16 piece 1/2" drive regular/deep impact socket set
3/7	TTXPB3	3 piece roll bar set
3/7	TTPSPG	4 piece power grip pliers with PS tray
4/7	TTX2640	7 piece AF combination spanner set
4/7	TT3592	8 piece AF combination spanner set
4/7	TTAF32	32 piece 1/4" and 3/8" drive AF socket set
4/7	TT1215AF	15 piece 1/2" drive AF regular socket set
4/7	TTALU	32 piece socket clip rail set
5/7	TTX3414	14 piece 3/4" drive metric socket set
5/7	TTX3404	4 piece 3/4" drive accessories set
5/7	TTX34AF	14 piece 3/4" drive AF socket set
Side Plate	BC424	Cutter Bolt 24 Inch
Side Plate	MB416	Plier Groove Joint Water Pump 16 Inch
Side Plate	PWC18	Wrench Aluminium Pipe 18 Inch
Side Plate	4008	Adjustable Wrench 24 Inch
-	580	Magnetic Bits Tray Round 6 Inch
-	TC-MAG	Tool Box Accessory Magnetic Tool Rail

Item ID: **TCMM600**



**STACK SYSTEM TOOL KIT**

479  
Pieces

- A complete tool kit covering the many of the requirements of most types of user
- The tools are laid out in individual tool trays using the TengTools Get Organised system
- Easy to see if any tools have been mislaid or lost helping to prevent leaving them with the work piece
- Supplied in a red TengTools 16 drawer stack system with a top box, middle box and roller cabinet with the distinctive TengTools eyes logo on the drop front of the top box
- A comprehensive selection of tools using 9 of the available 16 drawers ensuring that space is still available to add to the kit if needed

Item ID: TCMM479

138.3 kg



- 16 **Drawer**
- Heavy Gauge Steel**
- 5-Step Rust Protection**
- Comfort Grip Handle**
- 5" Castor Wheels with Brakes**
- 3 Step Ball Bearing Slides**
- Combination Lock**



Drawer 1/6    Drawer 2/6    Drawer 3/6



Drawer 4/6



Drawer 5/6



Drawer 6/6



Drawer 1/3



Drawer 2/3



Drawer 3/3



Drawer 1/7



Drawer 2/7



Drawer 3/7



Drawer 4/7



Drawer 5/10



Drawer 6/10



Drawer 7/10

Continued



Contents:		
Drawer Number	Item ID	Description
Storage 	TC806NF	Tool Box Top Box 6 Drawer
	TC803N	Tool Box Middle Box 3 Drawer
	TCW807N	Tool Box Roller Cabinet 7 Drawer
	TCW-SP01	Tool Box Roller Cabinet Side Panel
	TCW-HK10	Mixed Hooks 10Pcs
4/6	TT1435	35 piece 1/4" drive regular/deep metric socket set
4/6	TT3819	19 piece 3/8" drive metric socket set
4/6	TT1217	17 piece 1/2" drive regular metric socket set
4/6	TT1205	5 piece 1/2" drive socket accessories set
5/6	TT1236	12 piece metric combination spanner set
5/6	TT917N	7 piece Mega Drive screwdriver set
5/6	TT440	4 piece Mega Bite plier set
5/6	TTALU	32 piece socket clip rail set
6/6	TTPS09	9 piece general tool kit with PS tray
1/3	TTXEX113	13 piece extension set
1/3	TTX918N	8 piece Mega Drive screwdriver set
2/3	TT0516	16 piece oil service set
2/3	TTM116	16 piece mini plier/screwdriver set
2/3	TTHEK7	7 piece T handle hex driver set
2/3	TTTX7	7 piece T handle TX/TPX driver set
3/3	TT474-7	4 piece 7" circlip plier set
3/3	TT917TXN	7 piece TX/TPX Mega Drive screwdriver set
3/3	TTHEX23	23 piece metric hex bit socket set
3/3	TTTX23	23 piece 40/70mm TX bit socket set
1/7	I201	Flex Handle 1/2 Inch Drive 17 Inch
1/7	1425	Hex Key Set Mm 10 Piece Set

Contents:		
Drawer Number	Item ID	Description
1/7	1487	TX Key Set 7 Piece Set
1/7	586	Light Flexible With Magnet
1/7	641011	Wrench Flare Nut 12 X 11Mm
1/7	641213	Wrench Flare Nut 12 X 13Mm
1/7	661416	Wrench Flare Nut 7/16In X 1/2In
1/7	705	Hacksaw With 6 Inch Blades
1/7	9850	Circuit Tester
1/7	CALD150	Caliper Digital 150Mm
1/7	ID506	Impact Driver Set 6 Pieces
1/7	MB499-7T	Plier Wire Strippers 7 Inch Tpr Grip
1/7	MDS03N	Hose Clip Driver 6Mm/7Mm
1/7	SPBP20	Plier Spark Plug Boot Removal
1/7	TF30	Pipe Cutter 3-32Mm Capacity
1/7	TRC1012	Spark Plug Thread Cleaner
1/7	TRC1418	Thread Cleaner
1/7	TTX2032	7 piece metric combination spanner set
1/7	TT804	2 in 1 puller set
1/7	TTSM11	11 piece stud and nut remover set
2/7	TTX1292	1/2" drive torque wrench with flex handle
2/7	TTTD17	17 piece tap and die set
2/7	TTPC09	9 piece punch and chisel set
2/7	TTHR81	81 piece hand rivet set
2/7	TT9116N	16 piece 1/2" drive regular/deep impact socket set
3/7	TTXPB3	3 piece roll bar set
3/7	TTPSPG	4 piece power grip pliers with PS tray

Item ID: **TCMM479**

Used by professionals in the toughest environments around the world, you can rest assured that you are getting reliable tools from a trusted brand that have built their reputation in the industry for over 30 years.





**STACK SYSTEM TOOL KIT**

569 Pieces

- A complete tool kit covering the many of the requirements of most types of user
- The tools are laid out in individual tool trays using the TengTools Get Organised system
- Easy to see if any tools have been mislaid or lost helping to prevent leaving them with the work piece
- Supplied in a red TengTools SV style 16 drawer stack system with a top box, middle box and roller cabinet with the distinctive TengTools eyes logo on the drop front of the top box
- A comprehensive selection of tools using 9 of the available 16 drawers ensuring that space is still available to add to the kit if needed

Item ID: TCMM569EV

116 kg



- 16 Drawer
- Heavy Gauge Steel
- 5-Step Rust Protection
- 5" Castor Wheels with Brakes
- 3 Step Ball Bearing Slides
- Key Lock



Drawer 1/6    Drawer 2/6    Drawer 3/6



Drawer 4/6



Drawer 5/6



Drawer 6/6



Drawer 1/3



Drawer 2/3

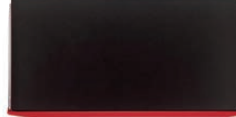

Drawer 3/3



Drawer 1/7



Drawer 2/7



Drawer 3/7



Drawer 4/7



Drawer 5/10



Drawer 6/10



Drawer 7/10

Continued



Contents:		
Drawer Number	Item ID	Description
Storage 	TC806SV	Tool Box Top Box 6 Drawer SV Series
	TC803SV	Tool Box Middle Box 3 Drawer SV Series
	TCW707EV	Tool Box Roller Cab 7 Drawer EV Series
4/6	TTDCT05	5 piece cutting tool set
4/6	TT440	4 piece Mega Bite plier set
4/6	TTVG05	5 piece power grip plier set
5/6	TTPC09	9 piece punch and chisel set
5/6	TTCP121	121 piece crimping tool set
5/6	TTDTD34	34 piece tap and die set
6/6	TTPS09	9 piece general tool set
1/3	TT1435	35 piece 1/4" drive regular/deep metric socket set
1/3	TT3819	19 piece 3/8" drive metric socket set
1/3	TT1218	18 piece 1/2" drive regular metric socket set
1/3	TT1211	11 piece 1/2" drive deep metric socket set
2/3	TT03	Storage tray with 4 compartments
2/3	TT04	Storage tray with 8 compartments
2/3	TTD00	Storage tray with 4 compartments
1/7	TTD01	Storage tray with 8 compartments
1/7	TTD02	Storage tray with 16 compartments
1/7	TTX03	Storage tray with 8 compartments

Contents:		
Drawer Number	Item ID	Description
2/7	TT1236	12 piece metric combination spanner set
2/7	TT6208	8 piece double open ended spanner set
2/7	TTHEX7	7 piece T handle hex wrench set
2/7	TTTX7	7 piece T handle TX wrench set
2/7	TTX2032	7 piece metric combination spanner set
3/7	TTDB28	Fully ground drill bit set (1.0 to 13.0mm)
3/7	TT00	Storage tray with tool clips
3/7	TTHR81	81 piece Rivet gun set
3/7	TTTM08	8 piece inspection tool set
3/7	TTXF05	5 piece hand file set
4/7	TTMD74	74 piece bits driver set
4/7	TT917N	7 piece screwdriver set
4/7	TT917TXN	7 piece TX driver set
4/7	TTHT28	28 piece hex key set
4/7	TTX918N	8 piece screwdriver set

Item ID: **TCMM569EV**

Stand out from the crowd!  
Distinctive Teng Tools branding  
on our tool kits shows the world  
that you are ready to succeed.



## EVA STACK SYSTEM TOOL KIT

530 Pieces



- A complete tool kit covering the requirements of most types of user
- All the tools are laid out in 3 colour pre-cut EVA foam trays with each tool having it's own place
- Clearly shows if any tools are not in their correct place to prevent losing tools or leaving them in the work piece
- Supplied in the TengTools TC805NFX full depth 5 drawer top box and TCW806N1 6 drawer roller cabinet

Item ID: TCMME09A

201.5 kg



- 11** Drawer
- Heavy Gauge Steel**
- 5-Step Rust Protection**
- Comfort Grip Handle**
- 5" Castor Wheels with Brakes**
- 3 Step Ball Bearing Slides**
- Combination Lock**



Drawer 1/5



Drawer 2/5



Drawer 3/5



Drawer 4/5



Drawer 5/5

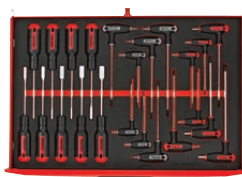

Drawer 1/6



Drawer 2/6



Drawer 3/6



Drawer 4/6

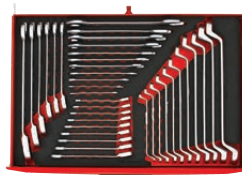

Drawer 5/6



Drawer 6/6

Continued





Contents:		
Drawer Number	Item ID	Description
Storage 	TC805NFX	Tool Box Top Box 5 Drawer
	TCW806N1	Tool Box Roller Cabinet 6 Drawers
1/5	TTESK86	Socket Set 1/4 and 3/8 inch Drive 86 Pieces
2/5	TTEISK73	Impact Socket Set 3/8 1/2 inch Drive 73 pieces
3/5	TTESK63	Socket Set 1/2 inch Drive 63 Pieces
4/5	TTEISK33	Impact Socket Set 3/4 inch Drive 33 pieces
5/5	TTESK32	Socket Set 3/4 inch Drive 32 Pieces

Contents:		
Drawer Number	Item ID	Description
1/6	TTEX23	Nut and T Handle Driver Set 23 Pieces
2/6	TTESP31	Spanner Set Combination 31 Pieces
3/6	TTEVG11	Plier Set Power Grip 11 Pieces
4/6	TTEM122N	Screwdriver Set 122 Pieces
5/6	TTESP37	Spanner Set Combination 37 Pieces
6/6	TTEMB17	Plier Set Power Grip 17 Pieces

Item ID: **TCMME09A**

## BUILT TO LAST

Designed to exceed the demands of any professional workshop



All of our tool storage is manufactured from heavy gauge, top quality steel. They are built to last!



During the manufacturing process our tool storage is powder coat painted with a 5-step rust prevention and undercoat.



Comfort grip handles. These top & middle boxes are supplied with rubber coated side handles while these tool cabinets are equipped with rubber soft grip transport handles.



Cabinets are fitted with castor wheels covered with high-quality rubber. Two fixed and two swivel with brakes. Fitted in a U-shaped bracket providing extra strength and stability.



All drawers are equipped with robust 3-step ball bearing slides allowing them to be fully extended easily to gain greater access to the tools.



Single drawer opening safety feature. On a selection of tool cabinets you can only open a single drawer at a time to avoid the cabinet falling over.



Improved combination locking system for extra security on all standard tool boxes and roller cabinets.



Keep your tools secure and safe when not in use with our selection of tool boxes and cabinets with a key lock.



## EVA STACK SYSTEM TOOL KIT

417  
Pieces



- A complete tool kit covering the requirements of most types of user
- All the tools are laid out in 3 colour pre-cut EVA foam trays with each tool having it's own place
- Clearly shows if any tools are not in their correct place to prevent losing tools or leaving them in the work piece
- Supplied in the TengTools TC806NF 6 drawer top box and TCW807N 7 drawer roller cabinet
- A comprehensive selection of tools using 7 of the available 13 drawers ensuring that space is still available to add to the kit if needed

Item ID: TCEMM417N

128 kg



- 13 Drawer
- Heavy Gauge Steel
- 5-Step Rust Protection
- Comfort Grip Handle
- 5" Castor Wheels with Brakes
- 3 Step Ball Bearing Slides
- Combination Lock



Drawer 1/6



Drawer 2/6



Drawer 3/6

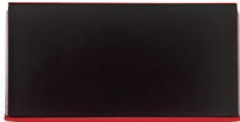

Drawer 4/6

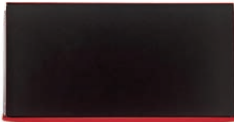

Drawer 5/6



Drawer 6/6



Drawer 1/7



Drawer 2/7



Drawer 3/7



Drawer 4/7



Drawer 5/7



Drawer 6/7



Drawer 7/7

Continued ↗



Contents:		
Drawer Number	Item ID	Description
Storage 	TC806NF	Tool Box Top Box 6 Drawer
	TCW807N	Tool Box Roller Cabinet 7 Drawer
6/6	TEDHEX7	7 piece T handle hex key set
6/6	TEDTX7	7 piece T handle TX key set
1/7	TEXEXT13	13 piece extension set
1/7	TED1489	89 piece 1/4" drive socket set
1/7	TED3836	36 piece 3/8" drive socket set
2/7	TEX1238	3/8" and 1/2" drive torque wrench set
2/7	TED1227	27 piece 1/2" drive socket set
2/7	TED441-T	5 piece plier set
3/7	TEX915N	5 piece screwdriver set
3/7	TED911N	11 piece screwdriver set
3/7	TED909TXN	9 piece TX driver set
4/7	TEXPB4	4 piece roll/heel bar set

Contents:		
Drawer Number	Item ID	Description
4/7	TEDSD95	95 piece torque screwdriver set
4/7	TEDPC14	14 piece punch and chisel set
5/7	TEX2032	7 piece metric combination spanner set
5/7	TED8012	12 piece metric combination spanner set
5/7	TEDADJ4	4 piece adjustable wrench set
6/7	TEXW05	5 piece wheel tool set
6/7	TED9121	21 piece 1/2" drive impact socket set
6/7	TEDHT42	42 piece hex and TX key set

Item ID: **TCEMM417N**



**WE TAKE PRIDE IN WHAT YOU DO**  
 At Teng Tools we know better tools bring better results



## EVA STACK SYSTEM TOOL KIT

249  
Pieces

EVA

- A complete tool kit covering the requirements of most types of user
- All the tools are laid out in 3 colour pre-cut EVA foam trays with each tool having it's own place
- Clearly shows if any tools are not in their correct place to prevent losing tools or leaving them in the work piece
- Supplied in the TengTools TC806NF 6 drawer top box and TCW807N 7 drawer roller cabinet
- A comprehensive selection of tools using 6 of the available 13 drawers ensuring that space is still available to add to the kit if needed

Item ID: TCEMM249N

114 kg



- 13 Drawer
- Heavy Gauge Steel
- 5-Step Rust Protection
- Comfort Grip Handle
- 5" Castor Wheels with Brakes
- 3 Step Ball Bearing Slides
- Combination Lock



Drawer 1/6



Drawer 2/6



Drawer 3/6

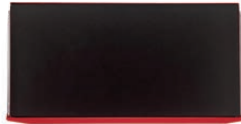

Drawer 4/6



Drawer 5/6



Drawer 6/6



Drawer 1/7



Drawer 2/7



Drawer 3/7



Drawer 4/7



Drawer 5/7



Drawer 6/7



Drawer 7/7

Continued ↗





Contents:		
Drawer Number	Item ID	Description
Storage 	TC806NF	Tool Box Top Box 6 Drawer
	TCW807N	Tool Box Roller Cabinet 7 Drawer
5/6	TEDV440	4 piece 1000 volt insulated plier set
5/6	TEDV909N	9 piece 1000 volt insulated screwdriver set
6/6	TEDHEX7	7 piece T handle hex key set
6/6	TEDTX7	7 piece T handle TX key set
1/7	TEEXT13	13 piece extension set
1/7	TED1489	89 piece 1/4" drive socket set
1/7	TED3836	36 piece 3/8" drive socket set

Contents:		
Drawer Number	Item ID	Description
2/7	TEX1238	3/8" and 1/2" drive torque wrench set
2/7	TED1227	27 piece 1/2" drive socket set
2/7	TED441-T	5 piece plier set
3/7	TEX915N	5 piece screwdriver set
3/7	TED911N	11 piece screwdriver set
3/7	TED909TXN	9 piece TX driver set
4/7	TEX2032	7 piece metric combination spanner set
4/7	TED8012	12 piece metric combination spanner set
4/7	TEDADJ4	4 piece adjustable wrench set

Item ID: TCEMM249N



**CHOICE | CUSTOMISATION | INNOVATION**

All things that make Teng Tools the right choice for you.



## EXTRA WIDE ROLLER CABINET TOOL KIT

622  
Pieces

- A complete tool kit covering many of the requirements of most types of user
- All the tools are laid out in individual tool trays using the TengTools Get Organised system
- Easy to see if any tools have been mislaid or lost helping to prevent leaving them with the work piece
- Supplied in the TengTools extra wide TCW207N 7 drawer 37" (950mm) wide roller cabinet
- A comprehensive selection of tools using 6 of the available 7 drawers ensuring that space is still available to add to the kit if needed

Item ID: TCMM622N

138 kg



- 7 Drawer
- 37" Wide Cabinet
- Heavy Gauge Steel
- 5-Step Rust Protection
- Comfort Grip Handle
- 5" Castor Wheels with Brakes
- 3 Step Ball Bearing Slides
- Single Drawer Opening
- Combination Lock



Drawer 1/7



Drawer 2/7



Drawer 3/7



Drawer 4/7



Drawer 5/7



Drawer 6/7



Drawer 7/7

Continued



Contents:		
Drawer Number	Item ID	Description
Storage 	TCW207N	Tool Box Roller Cabinet 37" 7 Drawer
	TC-TB03	948 mm Work Top
1/7	TTEX13	13 piece extension set
1/7	TT1435	35 piece 1/4" drive regular/deep metric socket set
1/7	TT3819	19 piece 3/8" drive metric socket set
1/7	TT1217	17 piece 1/2" drive regular socket set
1/7	TT1205	5 piece 1/2" drive socket accessory set
1/7	TTHEX7	7 piece T handle hex driver set
1/7	TTTX7	7 piece T handle TX driver set
1/7	TTZ01	Add on tool tray
2/7	TTX2032	7 piece combination spanner set
2/7	TT1236	12 piece combination spanner set
2/7	TTSN11	11 piece extractor set
2/7	TTOS16	16 piece oil service kit
2/7	TTMI16	16 piece mini tool set
2/7	TT474-7	4 piece 7" circlip plier set
2/7	TT440	4 piece plier set
2/7	TTZVG03	3 piece power grip plier set
3/7	TTX2640	7 piece AF combination spanner set
3/7	TT3592	8 piece AF combination spanner set
3/7	TTAF32	32 piece 1/4" and 3/8" drive regular/deep AF socket set
3/7	TT1215AF	15 piece 1/2" drive regular AF socket set
3/7	TTTX30	30 piece 1/4" and 3/8" drive TX, TPX and TX-E socket set
3/7	TTD17	17 piece tap and die set
3/7	TT804	4 piece 2 in 1 puller set
3/7	TTZ01	Add on tool tray

Contents:		
Drawer Number	Item ID	Description
4/7	TTX918N	8 piece screwdriver set
4/7	TTPS09	9 piece general tool kit
4/7	TT917N	7 piece screwdriver set
4/7	TT917TXN	7 piece TX/TPX driver set
4/7	TTZ01	Add on tool tray
5/7	TTX1292	1/2" drive torque wrench
5/7	TT9116N	16 piece 1/2" drive regular/deep impact socket set
5/7	TTHEX23	23 piece metric hex bit set
5/7	TTALU	32 piece socket clip rail set
5/7	TTX23	23 piece 40/70mm TX bit socket set
5/7	TTID20	20 piece 1/2" drive impact driver set
5/7	TTMD74	74 piece ratcheting bits driver set
5/7	TTZ01	Add on tool tray
6/7	TTX6311	11 piece metric double ring spanner set
6/7	TTXPB3	3 piece roll/heel bar set
6/7	TTXMB02	2 piece plier and adjustable wrench set
6/7	TTNR81	81 piece Nutsert rivet set
6/7	TTPC09	9 piece punch and chisel set
6/7	TTZ01	Add on tool tray

Item ID: **TCMM622N**



## EXTRA WIDE ROLLER CABINET TOOL KIT

569 Pieces

- A complete tool kit covering many of the requirements of most types of user
- All the tools are laid out in individual tool trays using the TengTools Get Organised system
- Easy to see if any tools have been mislaid or lost helping to prevent leaving them with the work piece
- Supplied in the TengTools double width TCW809N 9 drawer 53" wide roller cabinet
- A comprehensive selection of tools using 8 of the available 9 drawers ensuring that space is still available to add to the kit if needed

Item ID: TCMIND08

136 kg



- 9 Drawer
- 53" Wide Cabinet
- Heavy Gauge Steel
- 5-Step Rust Protection
- Comfort Grip Handle
- 6" Castor Wheels with Brakes
- 3 Step Ball Bearing Slides
- Combination Lock



Drawer 1/9



Drawer 2/9



Drawer 3/9



Drawer 4/9



Drawer 5/9



Drawer 6/9



Drawer 7/9



Drawer 8/9



Drawer 9/9

Continued





Contents:		
Drawer Number	Item ID	Description
Storage 	TCW809N	Tool Box Roller Cabinet 9 Drawer 53"
2/9	TTXEXT13	13 piece extension set
2/9	TT1435	35 piece 1/4" drive regular and deep metric socket set
2/9	TT3819	19 piece 3/8" drive regular metric socket set
2/9	TT1205	5 piece 1/2" drive socket accessories set
2/9	TT1217	17 piece 1/2" drive regular metric socket set
3/9	TTX474-9	4 piece 9" circlip plier set
3/9	TT440-T	4 piece Mega Bite plier set
3/9	TTVG05	5 piece power grip plier set
3/9	TTDCT05	5 piece cutting tool set
4/9	TTXF05	5 piece 10" file set
4/9	TTTX30	30 piece 1/4" and 3/8" drive TX, TPX and TX-E socket set
4/9	TTBS35	35 piece 1/4" and 3/8" drive TX, TPX and TX-E set
4/9	TTXH15	15 piece 1/2" drive long bits socket set
4/9	TTRS15	15 piece 1/2" drive Ribe and spline bits socket set
5/9	TTX2640	7 piece AF spanner set
5/9	TTAF32	32 piece 1/4" and 3/8" drive regular and deep socket set
5/9	TT1215AF	15 piece 1/2" drive AF regular socket set
5/9	TT3592	8 piece AF combination spanner set
5/9	TT3816	16 piece 3/8" drive deep metric socket set
6/9	TTX918N	8 piece Mega Drive screwdriver set
6/9	TT917N	7 piece Mega Drive screwdriver set
6/9	TT917TXN	7 piece TX/TPX Mega Drive screwdriver set
6/9	TTMD74	74 piece ratcheting bits driver set

Contents:		
Drawer Number	Item ID	Description
6/9	TTD828	28 piece drill bits set 1-13mm
7/9	TTX2032	7 piece metric combination spanner set
7/9	TT1236	12 piece metric combination spanner set
7/9	TT6508R	8 piece ratcheting combination spanner set
7/9	TT6208	8 piece open ended spanner set
7/9	TT474-7	4 piece 7" circlip plier set
8/9	TTX3404	4 piece 3/4" drive socket accessory set
8/9	TTHT28	28 piece hex and TX key set
8/9	TTHEX7	7 piece T handle hex driver set
8/9	TTTX7	7 piece T handle TX/TPX driver set
8/9	TTIM08	8 piece pick up tool set with light
9/9	TTX3414	14 piece 3/4" drive metric socket set
9/9	TT9207	7 piece 1/2" drive impact accessory set
9/9	TT9120DN	20 piece 1/2" drive impact regular and deep socket set
9/9	TTID20	20 piece 1/2" drive industrial impact driver set
9/9	TTBM	4 piece measuring set

Item ID: **TCMMIND08**



## ROLLER CABINET TOOL KIT

546 Pieces

- A complete tool kit covering many of the requirements of most types of user
- All the tools are laid out in individual tool trays using the TengTools Get Organised system
- Easy to see if any tools have been mislaid or lost helping to prevent leaving them with the work piece
- Supplied in a red TengTools TCW808N 8 drawer roller cabinet
- A comprehensive selection of tools using 7 of the available 8 drawers ensuring that space is still available to add to the kit if needed

Item ID: TCMM546N

84.7 kg



- 8 Drawer**
- Heavy Gauge Steel**
- 5-Step Rust Protection**
- Comfort Grip Handle**
- 5" Castor Wheels with Brakes**
- 3 Step Ball Bearing Slides**
- Combination Lock**



Drawer 1/8



Drawer 2/8



Drawer 3/8



Drawer 4/8



Drawer 5/8



Drawer 6/8



Drawer 7/8



Drawer 8/8

Continued



Contents:		
Drawer Number	Item ID	Description
Storage 	TCW808N	Tool Box Roller Cabinet 8 Drawer
1/8	TT1205	5 piece 1/2" drive socket accessory set
1/8	TT1217	17 piece 1/2" drive regular metric socket set
1/8	TT1435	35 piece 1/4" drive regular/deep metric socket set
1/8	TT3819	19 piece 3/8" drive regular metric socket set
1/8	TTXEXT13	13 piece extension set
2/8	TT01	Add on tool tray with dividers
2/8	TT917N	7 piece screwdriver set
2/8	TT917TXN	7 piece TX driver set
2/8	TTMD74	74 piece ratcheting bits driver set
2/8	TTXMDTN	5 piece screwdriver set
3/8	TT01	Add on tool tray with dividers
3/8	TTCP121	121 piece crimping plier set
3/8	TTHEX7	7 piece T handle hex key set
3/8	TTHR81	81 piece Rivet gun set
3/8	TTX00	Add on tool tray
4/8	TTHT28	28 piece hex and TX key set
4/8	TTMD12D	12 piece screwdriver set
4/8	TTNF12	12 piece needle file set
4/8	TTSR04	4 piece scraper set
4/8	TTXF05	5 piece hand file set

Contents:		
Drawer Number	Item ID	Description
5/8	TT1236	12 piece metric combination spanner set
5/8	TT440-T	4 piece plier set
5/8	TT474-7	4 piece 7" circlip plier set
5/8	TT6208	8 piece metric double open ended spanner set
5/8	TTX2032	7 piece metric combination spanner set
6/8	TT804	4 piece puller set
6/8	TTALU	32 piece socket clip rail set
6/8	TTPC09	9 piece punch and chisel set
6/8	TTTXH15	15 piece 1/2" drive hex and TX socket set
6/8	TTXMDN	9 piece nut driver set
7/8	TTPS09	9 piece general tool kit
7/8	TTX01	Add on tool tray with dividers

Item ID: **TCMM546N**



## ROLLER CABINET TOOL KIT

491 Pieces

- A complete tool kit covering many of the requirements of most types of user
- All the tools are laid out in individual tool trays using the TengTools Get Organised system
- Easy to see if any tools have been mislaid or lost helping to prevent leaving them with the work piece
- Supplied in a red TengTools TCW807N 7 drawer roller cabinet
- A comprehensive selection of tools using 6 of the available 7 drawers ensuring that space is still available to add to the kit if needed

Item ID: TCMM491N

83.4 kg



- 7 Drawer
- Heavy Gauge Steel
- 5-Step Rust Protection
- Comfort Grip Handle
- 5" Castor Wheels with Brakes
- 3 Step Ball Bearing Slides
- Combination Lock



Drawer 1/7



Drawer 2/7



Drawer 5/7

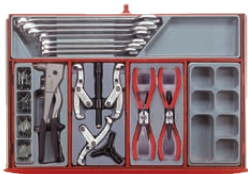

Drawer 6/7



Drawer 3/7



Drawer 4/7



Drawer 7/7

Item ID: TCMM491N

Contents:		
Drawer Number	Item ID	Description
Storage	TCW807N	Tool Box Roller Cabinet 7 Drawer
1/7	TTXMDN	9 piece nut driver set
1/7	TT1435	35 piece 1/4" drive regular/deep socket set
1/7	TT3819	19 piece 3/8" drive regular metric socket set
1/7	TT1236	12 piece metric combination spanner set
1/7	TT6208	8 piece metric double ended spanner set
2/7	TTXMDTN	5 piece power thru screwdriver set
2/7	TTMD74	74 piece ratcheting bits driver set
2/7	TTHEX7	7 piece metric hex T handle driver set
2/7	TT917N	7 piece screwdriver set
2/7	TT917TXN	7 piece TX/TPX screwdriver set
3/7	TTX00	Add on TTX tray
3/7	TT440-T	4 piece Mega Bite plier set
3/7	TTPC09	9 piece punch and chisel set
3/7	TTCP121	121 piece crimping tool set
3/7	TTX7	7 piece TX/TPX T handle driver set
4/7	TTX01	Add on tool tray with dividers
4/7	TTPS09	9 piece general tool kit with PS tray
5/7	TTXEXT13	13 piece extension set
5/7	TT1217	17 piece 1/2" drive regular metric 6 point socket set
5/7	TT1205	5 piece 1/2" drive socket accessories set
5/7	TTXH15	15 piece 1/2" drive 100mm long bit socket set
5/7	TTALU	32 piece socket clip rail set
6/7	TTX2032	7 piece metric combination spanner set
6/7	TTHR81	81 piece Rivet gun set
6/7	TT804	2 in 1 puller set
6/7	TT474-7	4 piece 7" circlip plier set
6/7	TT01	Add on tool tray with dividers



**ROLLER CABINET TOOL KIT**

277 Pieces

- A complete tool kit covering many of the requirements of most types of user
- All the tools are laid out in individual tool trays using the TengTools Get Organised system
- Easy to see if any tools have been mislaid or lost helping to prevent leaving them with the work piece
- Supplied in a red TengTools TCW707EV 7 drawer roller cabinet
- A comprehensive selection of tools using 4 of the available 7 drawers ensuring that space is still available to add to the kit if needed

Item ID: **TCMM277EV**

 74.3 kg

-  **7 Drawer**
-  **Heavy Gauge Steel**
-  **5-Step Rust Protection**
-  **5" Castor Wheels with Brakes**
-  **3 Step Ball Bearing Slides**
-  **Key Lock**



Contents:		
Drawer Number	Item ID	Description
Storage 	TCW707EV	Tool Box Roller Cab 7 Drawer SV Type
1/7	TT1435	35 piece 1/4" drive regular and deep metric socket set
1/7	TT3819	19 piece 3/8" drive regular metric socket set
1/7	TT1211	11 piece 1/2" drive deep metric socket set
1/7	TT1218	18 piece 1/2" drive regular metric socket set
1/7	TTXEXT13	3 piece extension set
2/7	TT1236	12 piece metric combination spanner set
2/7	TT6208	8 piece double open ended metric spanner set
2/7	TTHEX7	7 piece T handle hex driver set
2/7	TTTX7	7 piece T handle TX driver set
2/7	TTX2032	7 piece metric combination spanner set
3/7	TT440	4 piece plier set
3/7	TTVG05	5 piece power grip plier set
3/7	TTDCT05	5 piece cutting tool set
3/7	TTX1292	1/2" drive torque wrench
4/7	TTMD74	74 piece bits driver set
4/7	TT917N	7 piece screwdriver set
4/7	TT917TXN	7 piece TX driver set
4/7	TTHT28	28 piece hex and TX key set
4/7	TTX918N	8 piece screwdriver set



Drawer 1/7



Drawer 2/7



Drawer 3/7



Drawer 4/7



Drawer 5/7



Drawer 6/7



Drawer 7/7

Item ID: **TCMM277EV**





## EVA EXTRA WIDE ROLLER CABINET TOOL KIT

631 Pieces



- A complete tool kit covering the requirements of most types of user
- All the tools are laid out in 3 colour pre-cut EVA foam trays with each tool having it's own place
- Clearly shows if any tools are not in their correct place to prevent losing tools or leaving them in the work piece
- Supplied in the TengTools extra wide TCW207N 7 drawer 37" (950mm) wide roller cabinet
- A comprehensive selection of tools using 6 of the available 7 drawers ensuring that space is still available to add to the kit if needed

Item ID: TCEMM631N

138 kg



- 7 Drawer**
- 37" Wide Cabinet**
- Heavy Gauge Steel**
- 5-Step Rust Protection**
- Comfort Grip Handle**
- 5" Castor Wheels with Brakes**
- 3 Step Ball Bearing Slides**
- Single Drawer Opening**
- Combination Lock**



Drawer 1/7



Drawer 2/7



Drawer 3/7



Drawer 4/7



Drawer 5/7



Drawer 6/7



Drawer 7/7

Continued



Contents:		
Drawer Number	Item ID	Description
Storage 	TCW207N	Tool Box Roller Cabinet 37" 7 Drawer
	TC-TB03	Tool Box Accessory 948 mm Work Top
1/7	TTESK77	Socket Set Mixed Drives 77 Pieces
1/7	TEDHT42	Hex Key Set 42 Pieces
1/7	TEZ01	Tool Box Storage EVA Tray 3 Compartments
2/7	TTEX32	Spanner and File Set 32 Pieces
2/7	TEDDF7	Double Flex Wrench Set 7 Pieces
2/7	TEZ01	Tool Box Storage EVA Tray 3 Compartments
3/7	TTEMD122N	Screwdriver Set 122 Pieces
3/7	TEDV909N	Screwdriver Set 1000 Volt 9 Pieces
3/7	TEZ01	Tool Box Storage EVA Tray 3 Compartments
4/7	TTEMB11	Plier Set 11 Pieces
4/7	TEDV440	Plier Set 1000 Volt 4 Pieces
4/7	TEZ01	Tool Box Storage EVA Tray 3 Compartments
5/7	TTESK85	Socket Set Mixed Drives 85 Pieces
5/7	TEDSD95	Torque Screwdriver Set 5 Pieces
5/7	TEZ01	Tool Box Storage EVA Tray 3 Compartments
6/7	TTEPS12	Tool Set General Tools 12 Pieces
6/7	TEAHR81	Rivet Gun Set 81 Pieces
6/7	TEABS50	Impact Bits Set 50 Pieces
6/7	TEZ01	Tool Box Storage EVA Tray 3 Compartments

Item ID: **TCEMM631N**

Each tool kit has been meticulously compiled with the assistance of technicians from various industries





## EVA ROLLER CABINET TOOL KIT

333  
Pieces



- A complete tool kit covering many of the requirements of most types of user
- All the tools are laid out in 3 colour pre-cut EVA foam trays with each tool having it's own place
- Clearly shows if any tools are not in their correct place to prevent losing tools or leaving them in the work piece
- Supplied in the TengTools TCW807N 7 drawer roller cabinet

Item ID: TCMME11A

91.5 kg



- 7 Drawer**
- Heavy Gauge Steel**
- 5-Step Rust Protection**
- Comfort Grip Handle**
- 5" Castor Wheels with Brakes**
- 3 Step Ball Bearing Slides**
- Combination Lock**



Drawer 1/7



Drawer 2/7



Drawer 3/7



Drawer 4/7



Drawer 5/7



Drawer 6/7



Drawer 7/7

Contents:		
Drawer Number	Item ID	Description
Storage	TCW807N	Tool Box Roller Cabinet 7 Drawer
1/7	TTEMB11	Plier Set 11 Pieces
2/7	TTEMD98N	Screwdriver Set 98 Pieces
3/7	TTEPS12	Tool Set General Tools 12 Pieces
4/7	TTESK85	Socket Set Mixed Drives 85 Pieces
5/7	TTESK77	Socket Set Mixed Drives 77 Pieces
6/7	TTEX17	Torque and Hex Key Set 17 Pieces
7/7	TTEX32	Spanner and File Set 32 Pieces

Item ID: TCMME11A



**EVA ROLLER CABINET TOOL KIT**

280 Pieces **EVA**

- A complete tool kit covering many of the requirements of most types of user
- All the tools are laid out in 3 colour pre-cut EVA foam trays with each tool having it's own place
- Clearly shows if any tools are not in their correct place to prevent losing tools or leaving them in the work piece
- Supplied in the TengTools TCW807N 7 drawer roller cabinet
- A comprehensive selection of tools using 5 of the available 7 drawers ensuring that space is still available to add to the kit if needed

Item ID: TCMME09C

 87.7 kg

-  **7 Drawer**
-  **Heavy Gauge Steel**
-  **5-Step Rust Protection**
-  **Comfort Grip Handle**
-  **5" Castor Wheels with Brakes**
-  **3 Step Ball Bearing Slides**
-  **Combination Lock**



Drawer 1/7

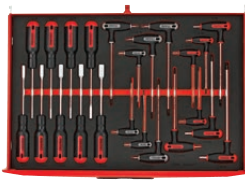

Drawer 2/7



Drawer 3/7



Drawer 4/7



Drawer 5/7



Drawer 6/7



Drawer 7/7

Contents:		
Drawer Number	Item ID	Description
Storage 	TCW807N	Tool Box Roller Cabinet 7 Drawer
1/7	TTESK86	Socket Set 1/4 and 3/8in drive 86 Pieces
2/7	TTEX23	Nut and T Handle Driver Set 23 Pieces
3/7	TTESP31	Spanner Set Combination 31 Pieces
4/7	TTEMB17	Plier Set Power Grip 17 Pieces
5/7	TTEMD122N	Screwdriver Set 122 Pieces

Item ID: TCMME09C



## EVA ROLLER CABINET TOOL KIT

179 Pieces

EVA

- All the tools are laid out in 3 colour pre-cut EVA foam trays with each tool having it's own place
- Clearly shows if any tools are not in their correct place to prevent losing tools or leaving them in the work piece
- Supplied in the TengTools TCW707EV 7 drawer roller cabinet
- A comprehensive selection of tools using just 3 of the available 7 drawers ensuring that space is still available to add to the kit if needed

Item ID: TCMME179

69 kg



- 7 Drawer
- Heavy Gauge Steel
- 5-Step Rust Protection
- 5" Castor Wheels with Brakes
- 3 Step Ball Bearing Slides
- Key Lock



Drawer 1/7



Drawer 2/7



Drawer 3/7



Drawer 4/7



Drawer 5/7



Drawer 6/7



Drawer 7/7

Contents:		
Drawer Number	Item ID	Description
Storage	TCW707EV	Tool Box Roller Cab 7 Drawer SV Type
1/7	TTEPS25	Tool Set General Tools 25 Pieces
2/7	TTESK126	Socket Set 1/4 and 1/2in drive 126 Pieces
3/7	TTESP28	Spanner and Screwdriver Set 28 Pieces

Item ID: TCMME179





**EVA ROLLER CABINET TOOL KIT**

174 Pieces

**EVA**

**NEW**

- All the tools are laid out in 3 colour pre-cut EVA foam trays with each tool having it's own place
- Clearly shows if any tools are not in their correct place to prevent losing tools or leaving them in the work piece
- Supplied in the TengTools TCW707EV 7 drawer roller cabinet with ABS top
- A comprehensive selection of tools using just 3 of the available 7 drawers ensuring that plenty of space is still available

Item ID: **TCMME174**

 62 kg



-  **7 Drawer**
-  **Heavy Gauge Steel**
-  **5-Step Rust Protection**
-  **5" Castor Wheels with Brakes**
-  **3 Step Ball Bearing Slides**
-  **Key Lock**



Drawer 1/7



Drawer 2/7



Drawer 3/7



Drawer 4/7



Drawer 5/7



Drawer 6/7



Drawer 7/7

Contents:		
Drawer Number	Item ID	Description
Storage 	TCW707EV	Tool Box Roller Cab 7 Drawer SV Type
	ABS-TOP	Roller Cabinet ABS Top
1/7	TTEPS25	Tool Set General Tools 25 Pieces
2/7	TTESK126	Socket Set 1/4 and 1/2in dr 126 Pieces
3/7	TTESP28	Spanner and Screwdriver Set 28 Pieces

Item ID: **TCMME174**



## MECHANICS STARTER KIT

20 Pieces

- Mechanics starter kit built up using the TengTools Get Organised tool tray system
- Supplied in a 6 drawer red top box with 3 full width drawers and 3 smaller drawers secured with a key lock
- Drop front with the TengTools logo to cover the drawers when the box is closed

Item ID: TC820SV

26 kg

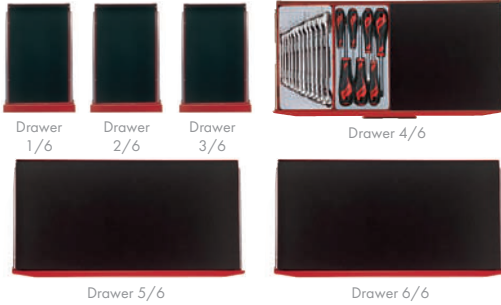

- 6 Drawer
- Heavy Gauge Steel
- 5-Step Rust Protection
- 3 Step Ball Bearing Slides
- Key Lock

Contents:		
Drawer Number	Item ID	Description
Storage	TC806SV	Tool Box Top Box 6 Drawer SV Series
4/6	TT1236	12 piece metric combination spanner set
4/6	TT917N	7 piece Mega Drive screwdriver set

Item ID: TC820SV

## MECHANICS STARTER KIT

140 Pieces

- A comprehensive mechanics starter kit built up using the TengTools Get Organised tool tray system
- Supplied in a 6 drawer red top box with 3 full width drawers and 3 smaller drawers secured with a combination lock
- Drop front with the TengTools logo to cover the drawers when the box is closed
- A handy lightweight plastic and aluminium tote tray is included for taking tools to the job in hand

Item ID: TC8140NF

42 kg



- 6 Drawer
- Heavy Gauge Steel
- 5-Step Rust Protection
- Comfort Grip Handle
- 3 Step Ball Bearing Slides
- Combination Lock



Contents:		
Drawer Number	Item ID	Description
Storage	TC806NF	Tool Box Top Box 6 Drawer
4/6	TT1435	35 piece 1/4" drive regular/deep metric socket set
4/6	TT3819	19 piece 3/8" drive regular metric socket set
4/6	TT1217	17 piece 1/2" drive regular metric socket set
4/6	TT1205	5 piece 1/2" drive socket accessories set
5/6	TT1236	12 piece metric combination spanner set
5/6	TT917N	7 piece Mega Drive screwdriver set
5/6	TT440-T	4 piece Mega Bite plier set
5/6	TTALU	32 piece socket clip rail set
6/6	TTPS09	9 piece general tool kit with PS tray

Item ID: TC8140NF



**MECHANICS STARTER KIT**

140 Pieces

- A comprehensive mechanics starter kit built up using the TengTools Get Organised tool tray system
- Supplied in a 6 drawer red top box with 3 full width drawers and 3 smaller drawers secured with a combination lock
- Drop front with the TengTools logo to cover the drawers when the box is closed
- A handy lightweight plastic and aluminium tote tray is included for taking tools to the job in hand

Item ID: **TC8140P**

 42 kg

-  **6 Drawer**
-  **Heavy Gauge Steel**
-  **5-Step Rust Protection**
-  **Comfort Grip Handle**
-  **3 Step Ball Bearing Slides**
-  **Combination Lock**



Contents:		
Drawer Number	Item ID	Description
Storage 	TC806NBK	Tool Box Top Box 6 Drawer Black
4/6	TT1435	35 piece 1/4" drive regular/deep metric socket set
4/6	TT3819	19 piece 3/8" drive regular metric socket set
4/6	TT1217	17 piece 1/2" drive regular metric socket set
4/6	TT1205	5 piece 1/2" drive socket accessories set
5/6	TT1236	12 piece metric combination spanner set
5/6	TT917N	7 piece Mega Drive screwdriver set
5/6	TT440-T	4 piece Mega Bite plier set
5/6	TTALU	32 piece socket clip rail set
6/6	TTPS09	9 piece general tool kit with PS tray

Item ID: **TC8140P**

**Personalised Tool Box Sticker**

This is now available to you through your local stockist. Send us the image that you would like to use and we will customise your tool kit for you. Images need to be supplied as high resolution jpeg, eps, PDF, or ai vector format.

\* Subject to artwork being supplied in the correct format.





## EVA TOP BOX TOOL KIT

280 Pieces



- A complete tool kit covering many of the requirements of most types of user
- All the tools are laid out in 3 colour pre-cut EVA foam trays with each tool having it's own place
- Clearly shows if any tools are not in their correct place to prevent losing tools or leaving them in the work piece
- Supplied in the TengTools TC805NFX full depth 5 drawer top box

Item ID: TCMME09B

67.8 kg



- 5 Drawer
- Heavy Gauge Steel
- 5-Step Rust Protection
- Comfort Grip Handle
- 3 Step Ball Bearing Slides
- Combination Lock



Drawer 1/5

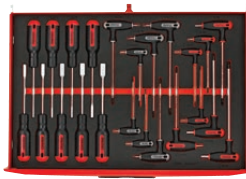

Drawer 2/5



Drawer 3/5



Drawer 4/5



Drawer 5/5

Contents:		
Drawer Number	Item ID	Description
	TC805NFX	Tool Box Top Box 5 Drawer
1/5	TTESK86	Socket Set 1/4 and 3/8in drive 86 Pieces
2/5	TTEX23	Nut and T Handle Driver Set 23 Pieces
3/5	TTESP31	Spanner Set Combination 31 Pieces
4/5	TTEMB17	Plier Set Power Grip 17 Pieces
5/5	TTEMD122N	Screwdriver Set 122 Pieces

Item ID: TCMME09B



# SERVICE CASES

## TOOLS ON THE MOVE

A moulded robust plastic body makes the case strong and stable

Tools are secured with a plastic lid allowing a clear view of where each tool is stored

The centre compartment sits loose in the case and can be easily lifted out when you need your tools

Carrying handles on the short and long sides to satisfy all needs

Retractable telescopic handle for easy transportation

Rubber castors make the case easy to pull and prevent it from sliding

Rubber feet mean the case does not slide around or damage painted surfaces

Equipped with a combination lock to protect your tools!

PORTABLE



Get organised™



CAN HOLD  
**9**  
TT TRAYS





## PORTABLE TOOL KIT

- Ideal for technicians
- Supplied in the unique TengTools TC-SC service case with the tools supplied in 9 TengTools TT trays
- Hard wearing flight case style carrying case with a combination lock and secure catches
- Complete with fixed castor wheels and retractable handle for easy carrying

113 Pieces

12.9 kg

Item ID: SC01



Contents:		
Compartment	Item ID	Description
1/3	TT1217	17 piece 1/2" drive regular metric socket set
1/3	TT1236	12 metric combination spanners
1/3	TT440-T	4 piece Mega Bite plier set
2/3	TT917N	7 piece Mega Drive screwdriver set
2/3	TT917TXN	7 piece Mega Drive TX/TPX screwdriver set
2/3	TTHEX7	7 piece metric T Handle hex key set
3/3	TT1435	35 piece 1/4" drive regular/deep metric socket set
3/3	TT3819	19 piece 3/8" drive regular metric socket set
3/3	TT1205	5 piece 1/2" drive socket accessory set

Item ID: SC01



Compartment 1



Compartment 2



Compartment 3

## PORTABLE TOOL KIT

- Supplied in the unique TengTools TC-SC service case with the tools supplied in 9 TengTools TT trays
- Hard wearing flight case style carrying case with a combination lock and secure catches
- Complete with fixed castor wheels and retractable handle for easy carrying

232 Pieces

10.3 kg

Item ID: SC02



Contents:		
Compartment	Item ID	Description
1/3	TT440	4 piece Mega Bite plier set
1/3	TTM116	16 piece mini plier and screwdriver set
1/3	TTCP121	Crimping plier with terminals and connectors
2/3	TTTM03	3 piece inspection tool set
2/3	TTNF12	12 piece needle file set
2/3	TTDB28	28 piece fully ground drill bit set
3/3	TT6508R	8 piece metric ratcheting combination spanner set
3/3	TTHT28	28 piece hex and TX key set
3/3	TTMD12D	12 piece double ended screwdriver set

Item ID: SC02



Compartment 1



Compartment 2



Compartment 3



**PORTABLE TOOL KIT**

- Supplied in the unique TengTools TC-SC service case with the tools supplied in 9 TengTools TT trays
- Hard wearing flight case style carrying case with a combination lock and secure catches
- Complete with fixed castor wheels and retractable handle for easy carrying

193 Pieces

 10.8 kg

Item ID: **SC03**

Contents:		
Compartment	Item ID	Description
1/3	TT440	4 piece plier set
1/3	TTM116	16 piece mini plier and screwdriver set
1/3	TTMD12D	12 piece screwdriver set
2/3	TT917N	7 piece screwdriver set
2/3	TT917TXN	7 piece TX driver set
2/3	TTMD74	74 piece ratcheting bits driver set
3/3	TT1435	35 piece 1/4" drive regular and deep metric socket set
3/3	TTBS35	35 piece 1/4" drive bit socket set
3/3	TTM03	3 piece inspection tool set



Item ID: **SC03**



Compartment 1



Compartment 2



Compartment 3

**PORTABLE TOOL KIT**

- Supplied in the unique TengTools TC-SC service case with the tools supplied in 9 TengTools TT trays
- Hard wearing flight case style carrying case with a combination lock and secure catches
- Complete with fixed castor wheels and retractable handle for easy carrying

100 Pieces

 15.3 kg

Item ID: **SC04**

Contents:		
Compartment	Item ID	Description
1/3	TT1236	12 piece combination spanner set
1/3	TT917N	7 piece Mega Drive screwdriver set
1/3	TT440-T	4 piece Mega Bite plier set
2/3	SCPS01	6 piece service tool set with ball pein hammer
3/3	TT1435	35 piece 1/4" drive regular/deep metric socket set
3/3	TT3819	19 piece 3/8" drive regular metric socket set
3/3	TT1218	17 piece 1/2" drive regular metric socket set



Item ID: **SC04**



Compartment 1



Compartment 2



Compartment 3



## PORTABLE TOOL KIT

- Supplied in the unique TengTools TC-SC service case with the tools supplied in 9 TengTools TT trays
- Hard wearing flight case style carrying case with a combination lock and secure catches
- Complete with fixed castor wheels and retractable handle for easy carrying

100 Pieces

13.6 kg

Item ID: SC04E



Contents:		
Compartment	Item ID	Description
1/3	TT1236	12 piece combination spanner set
1/3	TT917N	7 piece Mega Drive screwdriver set
1/3	TT440-T	4 piece Mega Bite plier set
2/3	SCPS01E	6 piece service tool set with engineers hammer
3/3	TT1435	35 piece 1/4" drive regular/deep metric socket set
3/3	TT3819	19 piece 3/8" drive regular metric socket set
3/3	TT1218	17 piece 1/2" drive regular metric socket set

Item ID: SC04E



Compartment 1



Compartment 2



Compartment 3

## EVA PORTABLE TOOL KIT

- Supplied in the unique TengTools TC-SC service case with the tools supplied in 3 EVA trays especially designed to fit the service case
- Tools are held in place using three colour pre-cut EVA foam clearly showing where each tool belongs
- Hard wearing flight case style carrying case with a combination lock and secure catches
- Complete with fixed castor wheels and retractable handle for easy carrying

118 Pieces



11.8 kg

Item ID: SCE1



Contents:		
Compartment	Item ID	Description
1/3	TEFMD54	54 piece screwdriver set with metric measuring tape
2/3	TEFMB7	7 piece plier and carpenters hammer set
3/3	TEFSK57	57 piece 1/4" and 3/8" drive socket and spanner set

Item ID: SCE1



Compartment 1



Compartment 2



Compartment 3





**EVA PORTABLE TOOL KIT**

118 Pieces

**EVA**

- Supplied in the unique TengTools TC-SC service case with the tools supplied in 3 EVA trays especially designed to fit the service case
- Tools are held in place using three colour pre-cut EVA foam clearly showing where each tool belongs
- Hard wearing flight case style carrying case with a combination lock and secure catches
- Complete with fixed castor wheels and retractable handle for easy carrying

 12 kg

Item ID: **SCE2**



Contents:		
Compartment	Item ID	Description
1/3	TEFMD154	54 piece screwdriver set with metric/AF measuring tape
2/3	TEFMBP7	7 piece plier and ball pein hammer set
3/3	TEFSK57	57 piece 1/4" and 3/8" drive socket and spanner set

Item ID: **SCE2**



Compartment 1



Compartment 2



Compartment 3



Tools on the move!  
Used in industries where wasting time searching for tools is not an option Teng Tools service cases are ideal for when you need portable tool organisation.



## PORTABLE TOOL KIT

187 Pieces

- A comprehensive selection of tools for mechanics
- Supplied in the TengTools Mega Rosso barn style tool box with aluminium clip rails and tools storage areas
- Padlock facility and full length piano hinges with turned edges for added safety

Item ID: TC187



1/4" Drive	30 socket clips, FRP ratchet, universal joint, 2" & 4" extensions, 3/8"F:1/4"M adaptor, coupler adaptor
3/8" Drive	30 socket clips, FRP ratchet, universal joint, 6" extension, 1/2"F:3/8"M adaptor
1/2" Drive	30 socket clips, FRP ratchet, universal joint, 2-1/2" and 6" extensions, 3/8"F:1/2"M adaptor
1/4" Drive 12 point sockets:	
Regular:	4, 5, 5.5, 6, 7, 8, 10, 11, 12, 13mm
Deep:	6, 7, 8, 10, 12, 13mm
3/8" Drive 6 point sockets:	
Regular:	8, 9, 10, 11, 12, 13, 14, 15, 16, 17, 18, 19, 21, 22mm
1/2" Drive 12 point sockets:	
Regular:	10, 11, 12, 13, 14, 15, 16, 17, 18, 19, 21, 22, 24, 27, 30, 32mm
1/4" Hex Bits:	TX8, TX10, TX15, TX20, TX25, TX27, TX30, TX40, 3mm, 4mm, 5mm, 6mm, 7mm, 8mm, 10mm Hex, PH1, PH2, PZ1, PZ2, 4mm, 5.5mm, 7mm flat
Spanners:	8, 10, 11, 12, 13, 14, 15, 17, 19mm Ring holder
Hex Keys:	1.5, 2.0, 2.5mm hex keys

Item ID: TC187

## MINI STARTER KIT

35 Pieces

- A selection of general hand tools in PS trays
- Supplied in a 2 drawer mini top box with 2 small drawers and storage space in the top compartment
- Drop front with the TengTools logo to cover the drawers when the box is closed

Item ID: TM035NF



Top



Drawer 1



Drawer 2

Contents:	
Drawer Number	Description
Top	1/4" drive regular sockets: 4, 5, 5.5, 6, 7, 8, 10, 12, 13mm 1/4" drive 2" extension, 1/4" bit ratchet 1/4" hex adaptor 1/4" hex bits: 4, 5.5, 6.5mm flat, PH1, PH2, PZ1, PZ2, TX10, TX15, TX20 Fold up bicycle tool set 4" Adjustable Wrench
Drawer 1	6" side cutter, 7" High leverage combination plier
Drawer 2	Combination spanners: 8, 9, 10, 11, 12, 13mm Screwdrivers: flat 5.5x75mm, PH1x75mm, insulated PH1 X 80mm

Item ID: TM035NF



1/4" Drive	FRP ratchet, universal joint, 2" and 4" extension bars, coupler adaptor, 3/8"F:1/4"M adaptor
1/2" Drive	FRP ratchet, universal joint, 2 1/2" and 6" extension bars, 3/8"F:1/2"M T bar adaptor
1/4" Drive 6 point sockets:	
Regular:	4, 5, 5.5, 6, 7, 8, 10, 11, 12, 13mm
Deep:	6, 7, 8, 10, 12, 13mm
1/2" Drive 12 point sockets:	
Regular:	10, 11, 12, 13, 14, 15, 16, 17, 18, 19, 21, 22, 24, 27, 30, 32mm
1/4" Hex Bits:	TX10, TX15, TX20, 5mm hex, 6mm hex, PH1, PH2, PZ1, PZ2, 4mm flat, 5.5mm flat
Spanners:	5.5, 6, 7, 8, 9, 10, 11, 12, 13, 14, 15, 16, 17, 18, 19mm
Hex Keys:	9 piece ball point hex key set, 1.5, 2.0 & 2.5mm hex keys, 10" adjustable wrench
Screwdrivers:	3.5mm, 5.5mm & 6.5mm flat, PH0, PH1, PH2, PZ0, PZ1, PZ2, 4mm flat 1000 volt insulated
Pliers:	8" combination, 8" long nose, 10" water pump, 6" side cutters, 8" side cutters, 10" power grip
Service Tools:	Drill bit set, magnetic lamp, measuring tape, hacksaw with spare blades, utility knife, centre punch, parallel pin punch set, soft face hammer, ball pein hammer, tin snips, magnetic bracelet

Item ID: **TC144D**

**PORTABLE TOOL KIT**

144 Pieces

- A comprehensive selection of tools for service technicians
- Supplied in the TengTools 5 drawer cantilever tool box (TC540)
- Padlock facility and full length piano hinges with turned edges for added safety

Item ID: **TC144D**



1/4" Drive	FRP ratchet, universal joint, 2" and 4" extension bars, coupler adaptor, 3/8"F:1/4"M adaptor
1/2" Drive	FRP ratchet, universal joint, 2 1/2" and 6" extension bars, 3/8"F:1/2"M T bar adaptor
1/4" Drive 6 point sockets:	
Regular:	4, 5, 5.5, 6, 7, 8, 10, 11, 12, 13mm
Deep:	6, 7, 8, 10, 12, 13mm
1/2" Drive 12 point sockets:	
Regular:	10, 11, 12, 13, 14, 15, 16, 17, 18, 19, 21, 22, 24, 27, 30, 32mm
1/4" Hex Bits:	TX10, TX15, TX20, 5mm hex, 6mm hex, PH1, PH2, PZ1, PZ2, 4mm flat, 5.5mm flat
Spanners:	5.5, 6, 7, 8, 9, 10, 11, 12, 13, 14, 15, 16, 17, 18, 19mm
Wrenches:	9 piece ball point hex key set, 1.5, 2.0 & 2.5mm hex keys, 10" adjustable wrench
Screwdrivers:	3.5mm, 5.5mm & 6.5mm flat, PH0, PH1, PH2, PZ0, PZ1, PZ2, 4mm flat 1000 volt insulated
Pliers:	8" combination, 8" long nose, 10" water pump, 6" side cutters, 8" side cutters, 10" power grip
Service Tools:	Drill bit set, magnetic lamp, measuring tape, hacksaw with spare blades, utility knife, centre punch, parallel pin punch set, soft face hammer, ball pein hammer, tin snips, magnetic bracelet

Item ID: **TC144E**

**PORTABLE TOOL KIT**

144 Pieces

- A comprehensive selection of tools for service technicians
- Supplied in the TengTools back pack for tools (TC5B)
- Shoulder straps and carrying handles make the kit easy to carry around
- Manufactured in polyester with an EVA plastic base, external pockets and a large internal compartment

Item ID: **TC144E**





**TOOL KIT AND WORK STATION**

545  
PIECES

- A complete tool kit combined with a top plate and back panels to create a work station
- The tools are laid out in individual tool trays using the TengTools Get Organised system
- The most commonly used tools are supplied in wall racks to keep them handy at the work station
- Easy to see if any tools have been mislaid or lost helping to prevent leaving them with the work piece
- Supplied in a red TengTools TCW807N 7 drawer roller cabinet complete with work top and panels
- A comprehensive selection of tools using 6 of the available 7 drawers ensuring that space is still available to add to the kit if needed

Item ID: TCMM545N

91.2 kg



- 7 Drawer**
- Heavy Gauge Steel**
- 5-Step Rust Protection**
- Comfort Grip Handle**
- 5" Castor Wheels with Brakes**
- 3 Step Ball Bearing Slides**
- Combination Lock**



Drawer 1/7



Drawer 2/7



Drawer 3/7



Drawer 4/7



Drawer 5/7



Drawer 6/7



Drawer 7/7

Continued





Contents:		
Drawer Number	Item ID	Description
Panel	WRF105	5 piece file set on a wall rack
Panel	WRMB04	4 piece plier set on a wall rack
Panel	WRMD910N	10 piece screwdriver set on a wall rack
Panel	WRSP12	12 metric combination spanner set on a wall rack
1/7	TTXEXT13	13 piece extension set
1/7	TT1435	35 piece 1/4" drive regular and deep metric socket set
1/7	TT3819	19 piece 3/8" drive regular metric socket set
1/7	TT1218	18 piece 1/2" drive regular metric socket set
1/7	TTXH15	15 piece 1/2" drive hex and TX bit socket set
2/7	TTXMDTN	5 piece screwdriver set
2/7	TTMD74	74 piece ratcheting bits driver set
2/7	TT917TXN	7 piece TX driver set
2/7	TTHEX7	7 piece T handle hex driver set
2/7	TTTX7	7 piece T handle TX driver set
3/7	TTXMDN	9 piece nut driver set
3/7	TTHR81	81 piece Rivet gun set
3/7	TT474-7	4 piece 7" circlip plier set
3/7	TT804	4 piece puller set
3/7	TT01	Add on tool tray with dividers

Contents:		
Drawer Number	Item ID	Description
4/7	TTX00	Add on tool storage tray
4/7	TTPC09	9 piece punch and chisel set
4/7	TTCP121	121 piece crimping tool set
4/7	TTDTD34	34 piece tap and die set
5/7	TTX2032	7 piece metric combination spanner set
5/7	TTDCT05	5 piece cutting tool set
5/7	TTIM08	8 piece inspection tool kit
5/7	TTBM	4 piece measuring set
6/7	TTX01	Add on tool tray with dividers
6/7	TTPS09E	9 piece service tool set

Item ID: **TCMM545N**

Each tool has its own specific place in your tool box. This creates a more efficient workflow and gives you more time to do what you do best every day.

# RACKING SYSTEM

**THE ULTIMATE** GARAGE OR WORKSHOP

 **INCREASE EFFICIENCY**

 **MAXIMISE SPACE**

Work better, work faster, know where every tool in your garage is exactly when you need it! The Racking System can be supplied with tools creating an unrivalled workspace and storage solution for you.

With the wide range of accessories available you can find everything that you need to build the workshop of your dreams.

**WORKSHOP STORAGE DESIGNED WITH PREMIUM FEATURES:**



**MADE FROM DURABLE HEAVY GAUGE STEEL**



**POWDER COAT PAINTED WITH A 5 STEP RUST PROTECTION**



**DRAWERS AND SHELVES BUILT TO TAKE A HIGH LOAD CAPACITY**



**ROBUST 3-STEP BALL BEARING SLIDES ON ALL DRAWERS**



**IMPROVED COMBINATION LOCK FOR EXTRA SECURITY**



**HEIGHT ADJUSTABLE STEEL SHELVES ACCOMMODATE DIFFERENT SIZED ITEMS**



**ADJUSTABLE FEET CREATING A LEVEL WORK SURFACE EVEN ON AN UNEVEN FLOOR**





# Get organised™



Combination locking system so you can rest assured the contents are safe



All drawers and shelves are built to last! They can handle the demands of any busy workshop

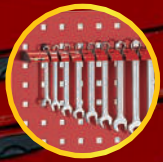

Back panels ideal for hanging tools and equipment keeping them within arms reach of your workspace



Supplied with adjustable legs to keep your work surface level and steady



Double high density laminated work surface that is durable and easy to clean



## RACKING TOOL KIT

- A comprehensive selection of 1,001 tools supplied in the TengTools Get Organised tool tray system
- All tools supplied in drawers with 3-step ball bearing slides
- A complete storage solution for the workshop
- Use on it's own or extend it further using the TengTools modular racking system

1001  
Pieces

**1 CHOOSE YOUR TOOLS**

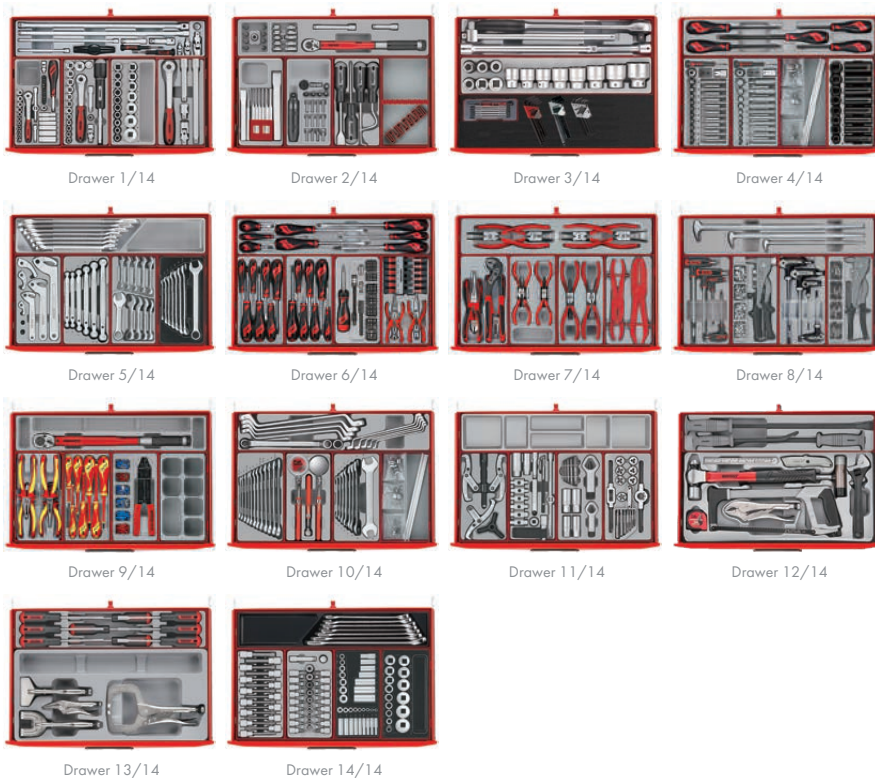

Contents:		
Drawer Number	Item ID	Description
1/14	TTXEXT13	13 piece extension set
1/14	TT1205	5 piece 1/2" drive socket accessories
1/14	TT1435	35 piece 1/4" drive regular/deep metric socket set
1/14	TT3819	19 piece 3/8" drive metric socket set
1/14	TT1217	17 piece 1/2" drive regular metric socket set
2/14	TTPC09	9 piece punch and chisel set
2/14	TTID20	20 piece 1/2" drive impact driver set
2/14	TTSR04	4 piece scraper and remover set
2/14	TT00	Add on tool tray
2/14	TTX3892	22 piece 3/8" drive torque wrench set
3/14	TTX3404	4 piece 3/4" drive socket accessories set
3/14	TTX3414	14 piece 3/4" drive metric socket set
3/14	TM708	8 piece mini screwdriver set
3/14	1479MM	9 piece ball point hex key wrench set
3/14	1479AF	9 piece AF ball point hex key wrench set

Contents:		
Drawer Number	Item ID	Description
3/14	1479TX	9 piece TX wrench set
4/14	TTTX23	23 piece 40/70mm TX bit socket set
4/14	TTHEX23	23 piece metric hex bit socket set
4/14	TTALU	32 piece socket clip rail set
4/14	TTXMDTN	5 piece power thru screwdriver set
4/14	TT9116N	16 piece 1/2" drive regular/deep impact socket set
5/14	TTHP08	8 piece hook and pin wrench set
5/14	TT6506	6 piece double flex wrench set
5/14	TT6010M	10 piece midget combination spanner set
5/14	TT3592	8 piece AF combination spanner set
5/14	TTX2032	7 piece metric combination spanner set
6/14	TTX918N	8 piece Mega Drive screwdriver set
6/14	TT917N	7 piece Mega Drive screwdriver set

Continued







Contents:		
Drawer Number	Item ID	Description
6/14	TT917TXN	7 piece TX/TPX Mega Drive screwdriver set
6/14	TTMD74	74 piece ratcheting bits driver set
6/14	TTMI16	16 piece mini plier/screwdriver set
7/14	TTX474-9	4 piece 9" circlip plier set
7/14	TT440-T	4 piece Mega Bite plier set
7/14	TT474-7	4 piece 7" circlip plier set
7/14	TT474-5	4 piece 5" circlip plier set
7/14	TTHC03	3 piece hose clamp set
8/14	TTHEX7	7 piece T handle hex driver set
8/14	TTNR81	81 piece nut rivet set
8/14	TTTX7	7 piece T handle TX/TPX drivers
8/14	TTHR81	81 piece rivet gun set
8/14	TTXPB3	3 piece roll/heel bar set
9/14	TTX1292	1/2" drive torque wrench
9/14	TTV440	4 piece 1000V insulated plier set
9/14	TTCP121	121 piece crimping tool set
9/14	TTV907N	7 piece 1000V screwdriver set
9/14	TT01	Add on tool tray with dividers
10/14	TT1236	12 piece metric combination spanner set
10/14	TTTM03	3 piece inspection tool set

Contents:		
Drawer Number	Item ID	Description
10/14	TT6208	8 piece open ended spanner set
10/14	TTX6311	11 piece metric double ring spanner set
10/14	TTALU	32 piece socket clip rail set
11/14	TTX01	Add on tool tray with dividers
11/14	TT804	2 in 1 puller set
11/14	TTOS16	16 piece oil service set
11/14	TTSN11	11 piece stud and nut remover set
11/14	TTTD17	17 piece tap and die set
12/14	TTPS09	9 piece general tool kit with PS tray
12/14	TTXPB3A	3 piece pry bar set
13/14	TTXMDN	9 piece nut driver set
13/14	TTSPG	4 piece power grip pliers set
14/14	TTX2640	7 piece AF combination spanner set
14/14	TTXH15	15 piece 1/2" drive long bits socket set
14/14	TT1215AF	15 piece 1/2" drive AF regular socket set
14/14	TTAF32	32 piece 1/4" and 3/8" drive regular/deep AF socket set
14/14	TTTX30	30 piece 1/4" and 3/8" drive TX, TPX and TX-E socket set

**2** CHOOSE YOUR MODULE

Module Size	Drawer Modules Included	Number of Pieces	Item ID
<b>XL</b>	 *12 Drawers	1001	RSMXL1001
<b>L</b>	 *12 Drawers	1001	RSML1001
<b>M</b>	 *16 Drawers	1001	RSMM1001



## RACKING TOOL KIT

715 Pieces

**1 CHOOSE YOUR TOOLS**

- A comprehensive selection of 715 tools supplied in the TengTools Get Organised tool tray system
- All tools supplied in drawers with 3-step ball bearing slides
- A complete storage solution for the workshop
- Use on it's own or extend it further using the TengTools modular racking system

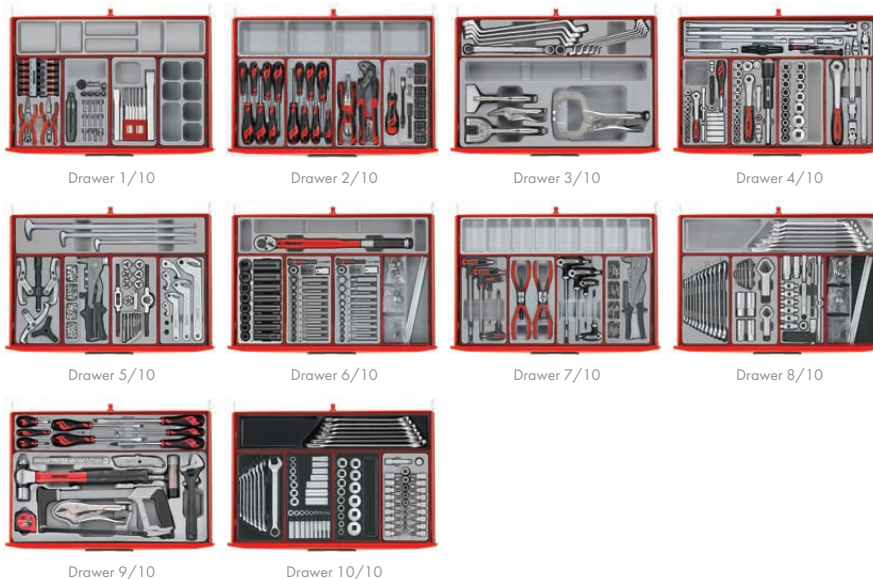

Contents:		
Drawer Number	Item ID	Description
1/10	TTX01	Empty 6 Compartment TTX Storage Tray
1/10	TTM116	16 piece mini plier/screwdriver set
1/10	TTID20	20 piece 1/2" drive impact driver set
1/10	TTPC09	9 piece punch and chisel set
1/10	TT01	Add on tool tray with dividers
4/10	TTXEXT13	13 piece extension set
4/10	TT1435	35 piece 1/4" drive regular/deep metric socket set
4/10	TT3819	19 piece 3/8" drive metric socket set
4/10	TT1217	17 piece 1/2" drive regular metric socket set
4/10	TT1205	5 piece 1/2" drive socket accessories set
5/10	TT804	2 in 1 puller set
5/10	TTNR81	81 piece nut rivet set
5/10	TTTD17	17 piece tap and die set mm
5/10	TTHP08	8 piece hook and pin wrench set
5/10	TTXPB3	3 piece roll bar set
2/10	TTX02	Empty 4 Compartment TTX Storage Tray
2/10	TT917N	7 piece Mega Drive screwdriver set
2/10	TT440-T	4 piece Mega Bite plier set
2/10	TT917TXN	7 piece TX/TPX Mega Drive screwdriver set
2/10	TTMD74	74 piece ratcheting bits driver set

Contents:		
Drawer Number	Item ID	Description
6/10	TTX1292	1/2" drive torque wrench
6/10	TT9116N	16 piece 1/2" drive regular/deep impact socket set
6/10	TTTX23	23 piece 40/70mm TX bit socket set
6/10	TTHEX23	23 piece metric hex bit socket set
6/10	TTALU	32 piece socket clip rail set
7/10	TTX03	Empty 8 Compartment TTX Storage Tray
7/10	TTHEX7	7 piece T handle hex driver set
7/10	TT474-7	4 piece 7" circlip plier set
7/10	TTTX7	7 piece T handle TX/TPX driver set
7/10	TTHR81	81 piece hand rivet set
3/10	TTSPG	4 piece power grip pliers with PS tray
3/10	TTX6311	11 piece mm double ring spanner set
8/10	TTALU	32 piece socket clip rail set
8/10	TTOS16	16 piece oil service set
8/10	TTSN11	11 piece stud and nut remover set
8/10	TT1236	12 piece metric combination spanner set
8/10	TTX2032	7 piece metric combination spanner set









Continued ↑



Contents:		
Drawer Number	Item ID	Description
9/10	TTPS09	9 piece general tool kit with PS tray
9/10	TTX918N	8 piece Mega Drive screwdriver set
10/10	TTTX30	30 piece 1/4" and 3/8" drive TX, TPX and TX-E socket set
10/10	TT1215AF	15 piece 1/2" drive AF regular socket set
10/10	TTAF32	32 piece 1/4" and 3/8" drive regular/deep AF socket set
10/10	TT3592	8 piece AF combination spanner set
10/10	TTX2640	7 piece AF combination spanner set



**2** CHOOSE YOUR MODULE

Module Size		Drawer Modules Included	Number of Pieces	Item ID
<b>XL</b>		 <b>x2</b> <i>*8 Drawers</i>	715	RSMXL715
<b>L</b>		 <b>x2</b> <i>*8 Drawers</i>	715	RSML715
<b>M</b>		 <b>x3</b> <i>*12 Drawers</i>	715	RSMM715
<b>S</b>		 <b>x3</b> <i>*12 Drawers</i>	715	RSMS715



## RACKING TOOL KIT

- A comprehensive selection of 569 tools supplied in the TengTools Get Organised tool tray system
- All tools supplied in drawers with 3-step ball bearing slides
- A complete storage solution for the workshop
- Use on it's own or extend it further using the TengTools modular racking system

569  
Pieces

**1 CHOOSE YOUR TOOLS**

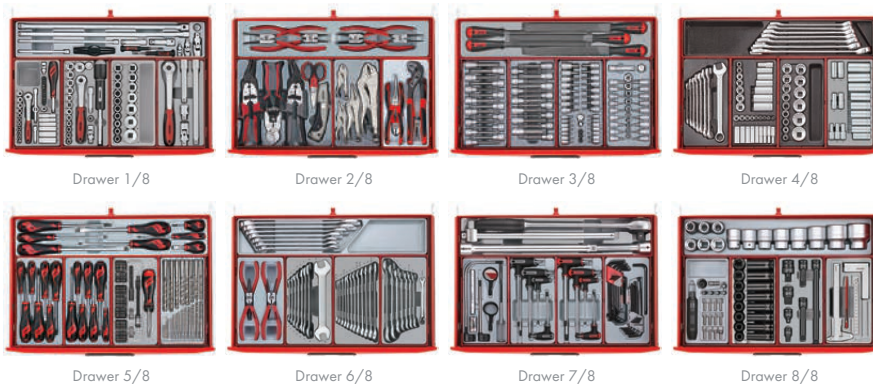

Contents:		
Drawer Number	Item ID	Description
1/8	TT1217	17 piece 1/2" drive regular metric socket set
1/8	TT1205	5 piece 1/2" drive socket accessories set
1/8	TT3819	19 piece 3/8" drive regular metric socket set
1/8	TT1435	35 piece 1/4" drive regular metric socket set
1/8	TTXEXT13	13 piece extension set
2/8	TTDCT05	5 piece cutting tool set
2/8	TTVG05	5 piece power grip plier set
2/8	TT440-T	4 piece Mega Bite plier set
2/8	TTX474-9	4 piece 9" circlip plier set
3/8	TTRS15	15 piece 1/2" drive RIL and spline bits socket set
3/8	TTTXH15	15 piece 1/2" drive long bits socket set
3/8	TTBS35	35 piece 1/4" and 3/8" drive TX, TPX and TX-E set
3/8	TTTX30	30 piece 1/4" and 3/8" drive TX, TPX and TX-E socket set
3/8	TTXF05	5 piece 10" file set
4/8	TT3816	16 piece 3/8" drive deep metric socket set
4/8	TT3592	8 piece AF combination spanner set
4/8	TT1215AF	15 piece 1/2" drive AF regular socket set
4/8	TTAF32	32 piece 1/4" and 3/8" drive socket set
4/8	TTX2640	7 piece AF spanner set
5/8	TTDB28	28 piece drill bits set 1-13mm
5/8	TTMD74	74 piece ratcheting bits driver set
5/8	TT917TXN	7 piece TX/TPX Mega Drive screwdriver set
5/8	TT917N	7 piece Mega Drive screwdriver set
5/8	TTX918N	8 piece Mega Drive screwdriver set







Contents:		
Drawer Number	Item ID	Description
6/8	TT6208	8 piece open ended spanner set
6/8	TT6508R	8 piece ratcheting combination spanner set
6/8	TT1236	12 piece metric combination spanner set
6/8	TTX2032	7 piece metric combination spanner set
6/8	TT474-7	4 piece 7" circlip plier set
7/8	TTTM08	8 piece pick up tool & light set
7/8	TTTX7	7 piece T handle TX/TPX driver set
7/8	TTHEX7	7 piece T handle hex driver set
7/8	TTHT28	28 piece hex and TX key set
7/8	TTX3404	4 piece 3/4" drive socket accessory set
8/8	TTBM	4 piece measuring set
8/8	TTID20	20 piece 1/2" drive industrial impact driver set
8/8	TT9120DN	20 piece 1/2" drive impact socket set - DIN standard
8/8	TT9207	7 piece 1/2" drive impact accessory set
8/8	TTX3414	14 piece 3/4" drive metric socket set

Continued ↑





**2** CHOOSE YOUR MODULE

Module Size		Drawer Modules Included	Number of Pieces	Item ID
<b>XL</b>		 <b>x2</b> <i>*8 Drawers</i>	569	RSMXL569
<b>L</b>		 <b>x2</b> <i>*8 Drawers</i>	569	RSML569
<b>M</b>		 <b>x2</b> <i>*8 Drawers</i>	569	RSMM569
<b>S</b>		 <b>x2</b> <i>*8 Drawers</i>	569	RSMS569



In a single purchase we offer you the opportunity to get a complete storage and workspace solution complete with industrial quality tools.



## RACKING TOOL KIT

- A comprehensive selection of 417 tools supplied in the TengTools Get Organised tool tray system
- All tools supplied in drawers with 3-step ball bearing slides
- A complete storage solution for the workshop
- Use on it's own or extend it further using the TengTools modular racking system

417  
Pieces

EVA

**1** CHOOSE YOUR TOOLS



Drawer 1/7



Drawer 2/7



Drawer 3/7



Drawer 4/7



Drawer 5/7



Drawer 6/7



Drawer 7/7









Continued

Contents:		
Drawer Number	Item ID	Description
1/7	TED3836	36 piece 3/8" drive socket set
1/7	TED1489	89 piece 1/4" drive socket set
1/7	TEXEXT13	13 piece extension set
2/7	TED441-T	5 piece plier set
2/7	TED1227	27 piece 1/2" drive socket set
2/7	TEX1238	3/8" and 1/2" drive torque wrench set
3/7	TED909TXN	9 piece TX driver set
3/7	TED911N	11 piece screwdriver set
3/7	TEX915N	5 piece screwdriver set
4/7	TEDPC14	14 piece punch and chisel set
4/7	TEDSD95	95 piece torque screwdriver set
4/7	TEXPB4	4 piece roll/heel bar set
5/7	TEDADJ4	4 piece adjustable wrench set
5/7	TED8012	12 piece metric combination spanner set
5/7	TEX2032	7 piece metric combination spanner set
6/7	TEXW05	5 piece wheel tool set
6/7	TEDHT42	42 piece hex and TX key set
6/7	TED9121	21 piece 1/2" drive impact socket set
7/7	TEDTX7	7 piece T handle TX key set
7/7	TEDHEX7	7 piece T handle hex key set
7/7	TEX02	Empty TEX Storage Tray 4 Compartments





**2** CHOOSE YOUR MODULE

Module Size		Drawer Modules Included	Number of Pieces	Item ID
<b>XL</b>		 <b>x2</b> <i>* 8 Drawers</i>	417	RSMXL417
<b>L</b>		 <b>x2</b> <i>* 8 Drawers</i>	417	RSML417
<b>M</b>		 <b>x2</b> <i>* 8 Drawers</i>	417	RSMM417
<b>S</b>		 <b>x2</b> <i>* 8 Drawers</i>	417	RSMS417



Manufactured with fully welded heavy gauge steel and with all of the 'Typically Teng' features that you would expect from Teng Tools. This Racking System is resilient and ready for the toughest workshop conditions.



## RACKING TOOL KIT

- A comprehensive selection of 333 tools supplied in the TengTools Get Organised tool tray system
- All tools supplied in drawers with 3-step ball bearing slides
- A complete storage solution for the workshop
- Use on it's own or extend it further using the TengTools modular racking system

333  
Pieces

EVA

**1** CHOOSE YOUR TOOLS



Drawer 1/7



Drawer 2/7



Drawer 3/7



Drawer 4/7



Drawer 5/7



Drawer 6/7



Drawer 7/7

Continued

Contents:		
Drawer Number	Item ID	Description
1/7	TTEX32	27 piece spanner set and 5 piece file set
2/7	TTESK85	85 piece hex sockets and bits set
3/7	TTESK77	77 piece 1/4", 3/8" and 1/2" drive socket set
4/7	TTEX17	17 piece hex key, inspection and torque wrench set
5/7	TTEPS12	12 piece set of general tool set
6/7	TTEMD98N	98 piece screwdriver set
7/7	TTEMB11	11 piece plier set











Endless combinations!  
All tools are supplied in the unique tool trays from the 'Get Organised' system that fit neatly into all cabinets and shelves. The vast selection of tools combined with the Racking System is now one of the widest on the market.





**2** CHOOSE YOUR MODULE

Module Size		Drawer Modules Included	Number of Pieces	Item ID
<b>XL</b>		 <b>x2</b> <i>* 8 Drawers</i>	333	RSMXL333
<b>L</b>		 <b>x2</b> <i>* 8 Drawers</i>	333	RSML333
<b>M</b>		 <b>x2</b> <i>* 8 Drawers</i>	333	RSMM333
<b>S</b>		 <b>x2</b> <i>* 8 Drawers</i>	333	RSMS333



# TOOL STORAGE

BUILT TO **LAST**

Teng Tools tool boxes and tool cabinets have been designed to meet the high demands made by professionals from all over the world. No details are left to chance when our tool boxes and roller cabinets are manufactured.

A full range of storage accessories, side tables, side drawers and tool panels are available and can be placed on both sides of all Teng Tools roller cabinets.



Improved combination locking system for extra security on all standard tool boxes and roller cabinets.



All of our tool storage is manufactured from heavy gauge, top quality steel. They are built to last!



During the manufacturing process our tool storage is powder coat painted with a 5-step rust prevention and undercoat







GET ORGANISED



Single drawer opening safety feature. On a selection of tool cabinets you can only open a single drawer at a time to avoid the cabinet falling over.



Comfort grip handles. These top & middle boxes are supplied with rubber coated side handles while these tool cabinets are equipped with rubber soft grip transport handles

The TengTools eyes appear on top boxes helping you stand out from the crowd!



Cabinets are fitted with castor wheels covered with high-quality rubber. Two fixed and two swivel with brakes. Fitted in a U-shaped bracket providing extra strength and stability.



All drawers are equipped with robust 3-step ball bearing slides allowing them to be fully extended easily to gain greater access to the tools





## STACK SYSTEM

- A 6 drawer top box (TC806NF) 3 drawer middle box (TC803N) and a 7 drawer roller cabinet (TCW807N) combined to create a stack system with 16 drawers
- Each full width drawer in the top and middle box is suitable for holding 4 TT trays
- The roller cabinet drawers will also hold a TTX tray as well as the 4 TT trays
- Each drawer is supplied with an EVA drawer mat
- A handy lightweight plastic and aluminium tote tray is included
- Drawers have ball bearing slides for a smoother and more reliable opening and closing action
- Use with the TengTools Get Organised system to build your ultimate tool kit

- 16 *Drawer*
- Heavy Gauge Steel
- 5-Step Rust Protection
- Comfort Grip Handle
- 5" Castor Wheels with Brakes
- 3 Step Ball Bearing Slides
- Combination Lock

Item ID: TC816STACK

## STACK SYSTEM

- A 6 drawer top box (TC806NBK) that can be personalised, a 3 drawer middle box (TC803NBK) and a 10 drawer roller cabinet (TCW810NBK) combined to create a stack system with 19 drawers
- Each full width drawer in the top and middle box is suitable for holding 4 TT trays
- The roller cabinet drawers will also hold a TTX tray as well as the 4 TT trays
- Each drawer is supplied with an EVA drawer mat
- A handy lightweight plastic and aluminium tote tray is included
- Drawers have ball bearing slides for a smoother and more reliable opening and closing action
- Use with the TengTools Get Organised system to build your ultimate tool kit

- 19 *Drawer*
- Heavy Gauge Steel
- 5-Step Rust Protection
- Comfort Grip Handle
- 5" Castor Wheels with Brakes
- 3 Step Ball Bearing Slides
- Combination Lock



ITEM ID:	Description
TC819NBK	Black Tool Kit with TengTools Logo sticker



**STACK SYSTEM**

- A 6 drawer top box (TC806SV) 3 drawer middle box (TC803SV) and a 7 drawer roller cabinet (TCW707EV) combined to create a stack system with 16 drawers
- Each full width drawer in the top and middle box is suitable for holding 4 TT trays
- The roller cabinet drawers will also hold a TTX tray as well as the 4 TT trays
- Drawers have ball bearing slides for a smoother and more reliable opening and closing action
- Use with the TengTools Get Organised system to build your ultimate tool kit

-  **16** Drawer
-  **Heavy Gauge Steel**
-  **5-Step Rust Protection**
-  **5" Castor Wheels with Brakes**
-  **3 Step Ball Bearing Slides**
-  **Key Lock**



Item ID: TC816SV



**Personalised Tool Box Sticker**

This is now available to you through your local stockist. Send us the image that you would like to use and we will customise your tool kit for you. Images need to be supplied as high resolution jpeg, eps, crr, or ai vector format.

\*Subject to artwork being supplied in the correct format.





**EXTRA WIDE STACK SYSTEM**

- A 10 drawer top box (TC810N) and a 6 drawer roller cabinet (TCW806LN) combined to create a stack system with 16 drawers
- The full width drawers are suitable for holding 8 TengTools TT trays plus 2 TTX trays
- Each drawer is supplied with an EVA drawer mat and plastic trimmed handle
- Drawers have ball bearing slides for a smoother and more reliable opening and closing action
- Use with the TengTools Get Organised system to build your ultimate tool kit



- 16 Drawer**
- 53" Wide Cabinet**
- Heavy Gauge Steel**
- 5-Step Rust Protection**
- Comfort Grip Handle**
- 6" Castor Wheels with Brakes**
- 3 Step Ball Bearing Slides**
- Combination Lock**

Item ID: TCW816LNSTACK

**EXTRA WIDE STACK SYSTEM**

- A 10 drawer top box (TC810N) and a 9 drawer roller cabinet (TCW809N) combined to create a stack system with 19 drawers
- Each regular width drawer is suitable for holding 4 TengTools TT trays plus a TTX tray
- The full width drawers are suitable for holding 8 TengTools TT trays plus 2 TTX trays
- Each drawer is supplied with an EVA drawer mat and plastic trimmed handle
- Drawers have ball bearing slides for a smoother and more reliable opening and closing action
- Use with the TengTools Get Organised system to build your ultimate tool kit



- 19 Drawer**
- 53" Wide Cabinet**
- Heavy Gauge Steel**
- 5-Step Rust Protection**
- Comfort Grip Handle**
- 6" Castor Wheels with Brakes**
- 3 Step Ball Bearing Slides**
- Combination Lock**

Item ID: TCW819STACK

**TOP BOX**

- Drop front with the TengTools logo to cover the drawers when the box is closed
- Each full width drawer is suitable for holding 4 TengTools TT trays
- Supplied with an EVA drawer mat and plastic trimmed handle
- A handy lightweight plastic and aluminium tote tray is included
- Drawers have ball bearing slides for a smoother and more reliable opening and closing action
- Supplied with rubber feet to prevent it from sliding and to avoid scratching
- Use with the TengTools Get Organised system to build your ultimate tool kit

	Width mm	Depth mm	Height mm	Capacity kg
Overall	660	305	380	
Drawer 1	170	275	50	30
Drawer 2	170	275	50	30
Drawer 3	170	275	50	30
Drawer 4	569	275	50	30
Drawer 5	569	275	50	30
Drawer 6	569	275	75	30

Drawer thickness mm	Body frame thickness mm	 kg
0.7	0.8	23.4

-  **6 Drawer**
-  **Heavy Gauge Steel**
-  **5-Step Rust Protection**
-  **Comfort Grip Handle**
-  **3 Step Ball Bearing Slides**
-  **Combination Lock**



Item ID: **TC806NF**

**TOP BOX**

- Drop front with the TengTools logo to cover the drawers when the box is closed
- Each full width drawer is suitable for holding 4 TengTools TT trays
- Supplied with an EVA drawer mat and plastic trimmed handle
- A handy lightweight plastic and aluminium tote tray is included
- Drawers have ball bearing slides for a smoother and more reliable opening and closing action
- Supplied with rubber feet to prevent it from sliding and to avoid scratching
- Use with the TengTools Get Organised system to build your ultimate tool kit

	Width mm	Depth mm	Height mm	Capacity kg
Overall	660	305	380	
Drawer 1	170	275	50	30
Drawer 2	170	275	50	30
Drawer 3	170	275	50	30
Drawer 4	569	275	50	30
Drawer 5	569	275	50	30
Drawer 6	569	275	75	30

Drawer thickness mm	Body frame thickness mm	 kg
0.7	0.8	23.4

-  **6 Drawer**
-  **Heavy Gauge Steel**
-  **5-Step Rust Protection**
-  **Comfort Grip Handle**
-  **3 Step Ball Bearing Slides**
-  **Combination Lock**



ITEM ID:	Description
TC806NBK	Black Tool Kit with TengTools Logo sticker

**Personalised Tool Box Sticker**

This is now available to you through your local stockist. Send us the image that you would like to use and we will customise your tool kit for you. Images need to be supplied as high resolution jpeg, eps, crr, or ai vector format.

\* Subject to artwork being supplied in the correct format.





## SV - TOP BOX

- Drop front with the TengTools logo to cover the drawers when the box is closed
- Each full width drawer is suitable for holding 4 TengTools TT trays or equivalent
- Drawers have ball bearing slides for a smoother and more reliable opening and closing action
- Supplied with rubber feet to prevent it from sliding and to avoid scratching
- Use with the TengTools Get Organised system to build your ultimate tool kit

-  **6 Drawer**
-  **Heavy Gauge Steel**
-  **5-Step Rust Protection**
-  **3 Step Ball Bearing Slides**
-  **Key Lock**

	Width mm	Depth mm	Height mm	Capacity kg
Overall	660	305	380	
Drawer 1	170	275	50	30
Drawer 2	170	275	50	30
Drawer 3	170	275	50	30
Drawer 4	569	275	50	30
Drawer 5	569	275	50	30
Drawer 6	569	275	75	30

Drawer thickness mm	Body frame thickness mm	kg
0.7	0.8	23.4

Item ID: TC806SV

## LARGE CAPACITY TOP BOX

- 5 full width drawers
- Drop front with the TengTools logo to cover the drawers when the box is closed
- Each drawer is suitable for holding 4 TengTools TT trays plus a TTX tray
- A handy lightweight plastic and aluminium tote tray is included
- Drawers have ball bearing slides for a smoother and more reliable opening and closing action
- Supplied with rubber feet to prevent it from sliding and to avoid scratching
- Use with the TengTools Get Organised system to build your ultimate tool kit



-  **5 Drawer**
-  **Heavy Gauge Steel**
-  **5-Step Rust Protection**
-  **Comfort Grip Handle**
-  **3 Step Ball Bearing Slides**
-  **Combination Lock**

	Width mm	Depth mm	Height mm	Capacity kg
Overall	660	455	483	
Drawer 1	575	380	50	30
Drawer 2	575	380	50	30
Drawer 3	575	380	75	30
Drawer 4	575	380	75	30
Drawer 5	575	380	75	30

Drawer thickness mm	Body frame thickness mm	kg
1	1	44

Item ID: TC805NFX



The lid of the top box folds down over the front to lock access to the drawers when not in use. The TengTools eyes keep watch!



**LARGE CAPACITY SV TOP BOX**

- 5 full width drawers
- Drop front with the TengTools logo to cover the drawers when the box is closed
- Each drawer is suitable for holding 4 TengTools TT trays plus a TTX tray
- Drawers have ball bearing slides for a smoother and more reliable opening and closing action
- Supplied with rubber feet to prevent it from sliding and to avoid scratching
- Use with the TengTools Get Organised system to build your ultimate tool kit

	Width mm	Depth mm	Height mm	Capacity kg
Overall	660	455	483	
Drawer 1	575	380	50	30
Drawer 2	575	380	50	30
Drawer 3	575	380	75	30
Drawer 4	575	380	75	30
Drawer 5	575	380	75	30

Drawer thickness mm	Body frame thickness mm	kg
1	1	44

-  **5 Drawer**
-  **Heavy Gauge Steel**
-  **5-Step Rust Protection**
-  **3 Step Ball Bearing Slides**
-  **Key Lock**



Item ID: TC805SV

**EXTRA WIDE TOP BOX**

- Each drawer is suitable for holding 4 TengTools TT trays plus a TTX tray
- Supplied with an EVA drawer mat and plastic trimmed handle
- Drawers have ball bearing slides for a smoother and more reliable opening and closing action
- Supplied with rubber feet to prevent it from sliding and to avoid scratching
- Use with the TengTools Get Organised system to build your ultimate tool kit

	Width mm	Depth mm	Height mm	Capacity kg
Overall	1337	455	560	
Drawer 1	575	380	75	30
Drawer 2	575	380	75	30
Drawer 3	575	380	75	30
Drawer 4	575	380	75	30
Drawer 5	575	380	75	30
Drawer 6	575	380	75	30
Drawer 7	575	380 <td 75	30	
Drawer 8	575	380	75	30
Drawer 9	575	380	75	30
Drawer 10	575	380	75	30

Drawer thickness mm	Body frame thickness mm	kg
0.7	0.8	90

-  **10 Drawer**
-  **53" Wide Cabinet**
-  **Heavy Gauge Steel**
-  **5-Step Rust Protection**
-  **Comfort Grip Handle**
-  **3 Step Ball Bearing Slides**
-  **Combination Lock**



Item ID: TC810N



### MIDDLE BOX

- Each full width drawer is suitable for holding 4 TengTools TT trays
- Supplied with an EVA drawer mat and plastic trimmed handle
- Drawers have ball bearing slides for a smoother and more reliable opening and closing action
- Supplied with rubber feet to prevent it from sliding and to avoid scratching
- Use with the TengTools Get Organised system to build your ultimate tool kit

- 3 Drawer**
- Heavy Gauge Steel**
- 5-Step Rust Protection**
- Comfort Grip Handle**
- 3 Step Ball Bearing Slides**
- Combination Lock**

	Width mm	Depth mm	Height mm	Capacity kg
Overall	660	305	250	
Drawer 1	569	275	50	30
Drawer 2	569	275	50	30
Drawer 3	569	275	75	30

Drawer thickness mm	Body frame thickness mm	kg
0.7	0.8	13

Item ID: TC803N

### MIDDLE BOX

- Each full width drawer is suitable for holding 4 TengTools TT trays
- Supplied with an EVA drawer mat and plastic trimmed handle
- Drawers have ball bearing slides for a smoother and more reliable opening and closing action
- Supplied with rubber feet to prevent it from sliding and to avoid scratching
- Use with the TengTools Get Organised system to build your ultimate tool kit



- 3 Drawer**
- Heavy Gauge Steel**
- 5-Step Rust Protection**
- Comfort Grip Handle**
- 3 Step Ball Bearing Slides**
- Combination Lock**

	Width mm	Depth mm	Height mm	Capacity kg
Overall	660	305	250	
Drawer 1	569	275	50	30
Drawer 2	569	275	50	30
Drawer 3	569	275	75	30

Drawer thickness mm	Body frame thickness mm	kg
0.7	0.8	13

Item ID: TC803NBK



Improved combination locking system is ideal if you do not want to carry a key or if more than one person needs access to a tool kit

**SV - MIDDLE BOX**

- Each full width drawer is suitable for holding 4 TengTools TT trays
- Drawers have ball bearing slides for a smoother and more reliable opening and closing action
- Supplied with rubber feet to prevent it from sliding and to avoid scratching
- Use with the TengTools Get Organised system to build your ultimate tool kit

	Width mm	Depth mm	Height mm	Capacity kg
Overall	660	305	250	
Drawer 1	569	275	50	30
Drawer 2	569	275	50	30
Drawer 3	569	275	75	30

Drawer thickness mm	Body frame thickness mm	 kg
0.7	0.8	13

-  **3 Drawer**
-  **Heavy Gauge Steel**
-  **5-Step Rust Protection**
-  **3 Step Ball Bearing Slides**
-  **Key Lock**



Item ID: TC803SV

**TOOL CABINET**

- Two 75mm deep drawers and one 154mm deep for storing larger items
- Storage compartment in the base fitted with a TengTools combination lock for secure storage of larger items
- Low height making it ideal for use beneath a low workbench
- Each drawer is suitable for holding 4 TengTools TT trays plus a TTX tray
- Supplied with an ABS top mat and EVA drawer mats in each drawer
- Drawers have ball bearing slides for a smoother and more reliable opening and closing action
- Use with the TengTools Get Organised system to build your ultimate tool kit

	Width mm	Depth mm	Height mm	Capacity kg
Cabinet	670	460	656	
Cabinet + Wheels	670	460	770	
Drawer 1	575	380	75	30
Drawer 2	575	380	75	30
Drawer 3	575	380	154	30
Base Storage	610	420	250	

Drawer thickness mm	Body frame thickness mm	 kg
1	1.2/1.0	44

-  **3 Drawer**
-  **Heavy Gauge Steel**
-  **5-Step Rust Protection**
-  **Comfort Grip Handle**
-  **4" Castor Wheels with Brakes**
-  **3 Step Ball Bearing Slides**
-  **Combination Lock**



Item ID: TCW803N

Cabinets are fitted with castor wheels covered with high-quality rubber. Two fixed and two swivel with brakes. Fitted in a U-shaped bracket providing extra strength and stability.





## TOOL CABINET

- Three 75mm deep drawers and one 312mm deep drawer for storing large items
- Low height making it ideal for use beneath a low workbench
- Each drawer is suitable for holding 4 TengTools TT trays plus a TTX tray
- Supplied with an ABS top mat and EVA drawer mats in each drawer
- Drawers have ball bearing slides for a smoother and more reliable opening and closing action
- Use with the TengTools Get Organised system to build your ultimate tool kit

- 4 Drawer**
- Heavy Gauge Steel**
- 5-Step Rust Protection**
- Comfort Grip Handle**
- 4" Castor Wheels with Brakes**
- 3 Step Ball Bearing Slides**
- Combination Lock**

	Width mm	Depth mm	Height mm	Capacity kg
Cabinet	670	460	656	
Cabinet + Wheels	670	460	770	
Drawer 1	575	380	75	30
Drawer 2	575	380	75	30
Drawer 3	575	380	75	30
Drawer 4	575	380	312	30

Drawer thickness mm	Body frame thickness mm	kg
1	1.2/1.0	49

Item ID: TCW804N

## TOOL CABINET

- Five 75mm deep drawers and one 154mm deep drawer for storing large items
- Low height making it ideal for use beneath a low workbench
- Each drawer is suitable for holding 4 TengTools TT trays plus a TTX tray
- Supplied with an ABS top mat and EVA drawer mats in each drawer
- Drawers have ball bearing slides for a smoother and more reliable opening and closing action
- Use with the TengTools Get Organised system to build your ultimate tool kit



- 6 Drawer**
- Heavy Gauge Steel**
- 5-Step Rust Protection**
- Comfort Grip Handle**
- 4" Castor Wheels with Brakes**
- 3 Step Ball Bearing Slides**
- Combination Lock**

	Width mm	Depth mm	Height mm	Capacity kg
Cabinet	670	460	656	
Cabinet + Wheels	670	460	770	
Drawer 1	575	380	75	30
Drawer 2	575	380	75	30
Drawer 3	575	380	75	30
Drawer 4	575	380	75	30
Drawer 5	575	380	75	30
Drawer 6	575	380	154	30

Drawer thickness mm	Body frame thickness mm	kg
1	1.2/1.0	54

Item ID: TCW806N



**TOOL CABINET**

- Five 75mm deep drawers and one 312mm deep drawer for storing large items
- Each drawer is suitable for holding 4 TengTools TT trays plus a TTX tray
- Supplied with an ABS top mat and EVA drawer mats in each drawer
- Drawers have ball bearing slides for a smoother and more reliable opening and closing action
- Use with the TengTools Get Organised system to build your ultimate tool kit

	Width mm	Depth mm	Height mm	Capacity kg
Cabinet	670	460	813	
Cabinet + Wheels	670	460	960	
Drawer 1	575	380	75	30
Drawer 2	575	380	75	30
Drawer 3	575	380	75	30
Drawer 4	575	380	75	30
Drawer 5	575	380	75	30
Drawer 6	575	380	312	30

Drawer thickness mm	Body frame thickness mm	kg
1	1.2/1.0	59.6

-  **6 Drawer**
-  **Heavy Gauge Steel**
-  **5-Step Rust Protection**
-  **Comfort Grip Handle**
-  **4" Castor Wheels with Brakes**
-  **3 Step Ball Bearing Slides**
-  **Combination Lock**



Item ID: TCW806N1

**TOOL CABINET**

- Five 75mm deep drawers and two 150mm deep drawers for storing large items
- Each drawer is suitable for holding 4 TengTools TT trays plus a TTX tray
- Supplied with an ABS top mat and EVA drawer mats in each drawer
- Drawers have ball bearing slides for a smoother and more reliable opening and closing action
- Use with the TengTools Get Organised system to build your ultimate tool kit

	Width mm	Depth mm	Height mm	Capacity kg
Cabinet	670	460	813	
Cabinet + Wheels	670	460	960	
Drawer 1	575	380	75	30
Drawer 2	575	380	75	30
Drawer 3	575	380	75	30
Drawer 4	575	380	75	30
Drawer 5	575	380	75	30
Drawer 6	575	380	154	30
Drawer 7	575	380	154	30

Drawer thickness mm	Body frame thickness mm	kg
1	1.2/1.0	64

-  **7 Drawer**
-  **Heavy Gauge Steel**
-  **5-Step Rust Protection**
-  **Comfort Grip Handle**
-  **5" Castor Wheels with Brakes**
-  **3 Step Ball Bearing Slides**
-  **Combination Lock**



Item ID: TCW807N



**EV - TOOL CABINET**

- Five 75mm deep drawers and two 150mm deep for storing larger items
- Each drawer is suitable for holding 4 TengTools TT trays plus a TTX tray
- Drawers have ball bearing slides for a smoother and more reliable opening and closing action
- Use with the TengTools Get Organised system to build your ultimate tool kit

- 7** Drawer
- Heavy Gauge Steel**
- 5-Step Rust Protection**
- 5" Castor Wheels with Brakes**
- 3 Step Ball Bearing Slides**
- Key Lock**

	Width mm	Depth mm	Height mm	Capacity kg
Cabinet	670	460	813	
Cabinet + Wheels	670	460	960	
Drawer 1	575	380	75	30
Drawer 2	575	380	75	30
Drawer 3	575	380	75	30
Drawer 4	575	380	75	30
Drawer 5	575	380	75	30
Drawer 6	575	380	154	30
Drawer 7	575	380	154	30

Drawer thickness mm	Body frame thickness mm	kg
1	1.2/1.0	64

Item ID: TCW707EV

**TOOL CABINET**

- Seven 75mm deep drawers and one 150mm deep drawer for storing large items
- Each drawer is suitable for holding 4 TengTools TT trays plus a TTX tray
- Supplied with an ABS top mat and EVA drawer mats in each drawer
- Drawers have ball bearing slides for a smoother and more reliable opening and closing action
- Use with the TengTools Get Organised system to build your ultimate tool kit



- 8** Drawer
- Heavy Gauge Steel**
- 5-Step Rust Protection**
- Comfort Grip Handle**
- 5" Castor Wheels with Brakes**
- 3 Step Ball Bearing Slides**
- Combination Lock**

	Width mm	Depth mm	Height mm	Capacity kg
Cabinet	670	460	813	
Cabinet + Wheels	670	460	960	
Drawer 1	575	380	75	30
Drawer 2	575	380	75	30
Drawer 3	575	380	75	30
Drawer 4	575	380	75	30
Drawer 5	575	380	75	30
Drawer 6	575	380	75	30
Drawer 7	575	380	75	30
Drawer 8	575	380	154	30

Drawer thickness mm	Body frame thickness mm	kg
1	1.2/1.0	61

Item ID: TCW808N

**TOOL CABINET**

- Six 50mm deep drawers, three 75mm deep drawers and one 150mm deep drawer for storing large items
- Each drawer is suitable for holding 4 TengTools TT trays plus a TTX tray
- Supplied with an ABS top mat and EVA drawer mats in each drawer
- Drawers have ball bearing slides for a smoother and more reliable opening and closing action
- Use with the TengTools Get Organised system to build your ultimate tool kit

	Width mm	Depth mm	Height mm	Capacity kg
Cabinet	670	460	813	
Cabinet + Wheels	670	460	960	
Drawer 1	575	380	48.7	30
Drawer 2	575	380	48.7	30
Drawer 3	575	380	48.7	30
Drawer 4	575	380	48.7	30
Drawer 5	575	380	48.7	30
Drawer 6	575	380	48.7	30
Drawer 7	575	380	75	30
Drawer 8	575	380	75	30
Drawer 9	575	380	75	30
Drawer 10	575	380	154	30

Drawer thickness mm	Body frame thickness mm	kg
1	1.2/1.0	69

-  **10 Drawer**
-  **Heavy Gauge Steel**
-  **5-Step Rust Protection**
-  **Comfort Grip Handle**
-  **5" Castor Wheels with Brakes**
-  **3 Step Ball Bearing Slides**
-  **Combination Lock**



Item ID: TCW810N

**TOOL CABINET**

- Six 50mm deep drawers, three 75mm deep drawers and one 150mm deep drawer for storing large items
- Each drawer is suitable for holding 4 TengTools TT trays plus a TTX tray
- Supplied with an ABS top mat and EVA drawer mats in each drawer
- Drawers have ball bearing slides for a smoother and more reliable opening and closing action
- Use with the TengTools Get Organised system to build your ultimate tool kit

	Width mm	Depth mm	Height mm	Capacity kg
Cabinet	670	460	813	
Cabinet + Wheels	670	460	960	
Drawer 1	575	380	48.7	30
Drawer 2	575	380	48.7	30
Drawer 3	575	380	48.7	30
Drawer 4	575	380	48.7	30
Drawer 5	575	380	48.7	30
Drawer 6	575	380	48.7	30
Drawer 7	575	380	75	30
Drawer 8	575	380	75	30
Drawer 9	575	380	75	30
Drawer 10	575	380	154	30

Drawer thickness mm	Body frame thickness mm	kg
1	1.2/1.0	69

-  **10 Drawer**
-  **Heavy Gauge Steel**
-  **5-Step Rust Protection**
-  **Comfort Grip Handle**
-  **5" Castor Wheels with Brakes**
-  **3 Step Ball Bearing Slides**
-  **Combination Lock**



Item ID: TCW810NBK



## 9 SERIES - TOOL CABINET

- 7 full width soft close drawers
- Each drawer has an individual opening mechanism secured with a combination lock
- Five 75mm deep drawers and two 150mm deep drawers for storing large items
- Each drawer is suitable for holding 4 TengTools TT trays plus a TTX tray
- Supplied with an ABS top mat and EVA drawer mats in each drawer
- Drawers have ball bearing slides for a smoother and more reliable opening and closing action
- Use with the TengTools Get Organised system to build your ultimate tool kit

-  **Drawer**
-  **Soft Close Drawers**
-  **Heavy Gauge Steel**
-  **5-Step Rust Protection**
-  **Comfort Grip Handle**
-  **5" Castor Wheels with Brakes**
-  **3 Step Ball Bearing Slides**
-  **Combination Lock**

	Width mm	Depth mm	Height mm	Capacity kg
Cabinet	670	460	813	
Cabinet + Wheels	670	460	960	
Drawer 1	575	380	75	30
Drawer 2	575	380	75	30
Drawer 3	575	380	75	30
Drawer 4	575	380	75	30
Drawer 5	575	380	75	30
Drawer 6	575	380	154	30
Drawer 7	575	380	154	30

Drawer thickness mm	Body frame thickness mm	kg
1	1.2/1.0	64

Item ID: TCW907X



## WIDE TOOL CABINET

- Only one drawer can be opened at a time to make the roller cabinet more stable
- Five 75mm deep drawers and two 150mm deep for storing larger items
- Each drawer is suitable for holding 6 TengTools TT trays together with 2 TTX trays and a TTZ tray
- Supplied with a rubber top mat, EVA drawer mats and plastic trimmed handles
- Drawers have ball bearing slides for a smoother and more reliable opening and closing action
- Use with the TengTools Get Organised system to build your ultimate tool kit

-  **Drawer**
-  **37" Wide Cabinet**
-  **Heavy Gauge Steel**
-  **5-Step Rust Protection**
-  **Comfort Grip Handle**
-  **5" Castor Wheels with Brakes**
-  **3 Step Ball Bearing Slides**
-  **Single Drawer Opening**
-  **Combination Lock**

	Width mm	Depth mm	Height mm	Capacity kg
Cabinet	953	460	813	
Cabinet + Wheels	953	460	960	
Drawer 1	860	380	75	15
Drawer 2	860	380	75	15
Drawer 3	860	380	75	15
Drawer 4	860	380	75	15
Drawer 5	860	380	75	15
Drawer 6	860	380	154	15
Drawer 7	860	380	154	15

Item ID: TCW207N



**EXTRA WIDE TOOL CABINET**

- A selection of 13 different size drawers to suit all sorts of storage
- Supplied with an EVA drawer mat for storing other tools and items
- Drawers have ball bearing slides for a smoother and more reliable opening and closing action
- An additional storage compartment fitted with a combination lock for storage of larger items
- Supplied with a wooden top plate to create a hard wearing work surface
- Use with the TengTools Get Organised system to build your ultimate tool kit



	Width mm	Depth mm	Height mm	Capacity kg
Cabinet	1700	460	974	
Cabinet + Wheels	1700	460	1153	
Drawer 1	575	380	75	30
Drawer 2	575	380	75	30
Drawer 3	575	380	75	30
Drawer 4	575	380	75	30
Drawer 5	575	380	75	30
Drawer 6	575	380	154	30
Drawer 7	575	380	312	30
Drawer 8	288	380	75	30
Drawer 9	288	380	75	30
Drawer 10	288	380	75	30
Drawer 11	288	380	154	30
Drawer 12	288	380	154	30
Drawer 13	1567	380	120	40









-  **13 Drawer**
-  **67" Wide Cabinet**
-  **Heavy Gauge Steel**
-  **5-Step Rust Protection**
-  **Comfort Grip Handle**
-  **6" Castor Wheels with Brakes**
-  **3 Step Ball Bearing Slides**
-  **Combination Lock**

Item ID: TCW814N

**EXTRA WIDE TOOL CABINET**

- Three 65mm deep drawers, one 100mm deep and three 154mm deep drawers for storing large items
- Each drawer is suitable for holding 8 TengTools TT trays plus 2 TTX trays
- Supplied with an EVA mat in each drawer
- Drawers have ball bearing slides for a smoother and more reliable opening and closing action
- Supplied with a wooden top plate to create a hard wearing work surface
- Use with the TengTools Get Organised system to build your ultimate tool kit



-  **6 Drawer**  **Single Drawer Opening**
-  **53" Wide Cabinet**
-  **Heavy Gauge Steel**
-  **5-Step Rust Protection**
-  **Comfort Grip Handle**
-  **6" Castor Wheels with Brakes**
-  **3 Step Ball Bearing Slides**
-  **Combination Lock**

	Width mm	Depth mm	Height mm	Capacity kg
Cabinet	1350	460	767	
Cabinet + Wheels	1350	460	937	
Drawer 1	1215	380	65	40
Drawer 2	1215	380	65	40
Drawer 3	1215	380	65	40
Drawer 4	1215	380	100	40
Drawer 5	1215	380	154	40
Drawer 6	1215	380	154	40

Drawer thickness mm	Body frame thickness mm	kg
1	1.2	144.5

Item ID: TCW806LN



**EXTRA WIDE TOOL CABINET**

- Six 75mm deep drawers, two 150mm deep and one 124mm deep full width drawer for storing large items
- Each regular width drawer is suitable for holding 4 TengTools TT trays plus a TTX tray
- The full width drawer is suitable for holding 8 TengTools TT trays plus 2 TTX trays
- Supplied with an EVA mat in each drawer
- Drawers have ball bearing slides for a smoother and more reliable opening and closing action
- Supplied with a wooden top plate to create a hard wearing work surface
- Use with the TengTools Get Organised system to build your ultimate tool kit

-  **9 Drawer**
-  **53" Wide Cabinet**
-  **Heavy Gauge Steel**
-  **5-Step Rust Protection**
-  **Comfort Grip Handle**
-  **6" Castor Wheels with Brakes**
-  **3 Step Ball Bearing Slides**
-  **Combination Lock**

	Width mm	Depth mm	Height mm	Capacity kg
Cabinet	1350	460	767	
Cabinet + Wheels	1350	460	937	
Drawer 1	1215	380	124	40
Drawer 2	575	380	75	30
Drawer 3	575	380	75	30
Drawer 4	575	380	75	30
Drawer 5	575	380	75	30
Drawer 6	575	380	75	30
Drawer 7	575	380	75	30
Drawer 8	575	380	154	30
Drawer 9	575	380	154	30

Drawer thickness mm	Body frame thickness mm	kg
1	1.2	152.5

Item ID: TCW809N

Cabinets with a worksurface create a mobile work station ideal for keeping your tools close when you need them





Heavy Gauge Steel



5-Step Rust Protection



Key Lock



**SIDE CUPBOARD**

- Designed to fit on the side of a TengTools cabinet to create additional storage
- Fully lockable with a key lock
- Fitted shelf included making it ideal for storing aerosols and bulkier items
- 400(W)x200(D)x500(H) mm

Item ID: TCW-CAB



Heavy Gauge Steel



5-Step Rust Protection



Combination Lock



**SIDE CABINET**

- Designed to fit on the side of a TengTools cabinet to create additional storage
- Fully lockable with a combination lock
- When mounting to a cabinet with a back panel fitted a side plate (Item ID: TCW-SP01) must be used to install
- 382(W)x460(D)x795(H) mm

Item ID: TCW-CAB02



7 Drawer



Heavy Gauge Steel



5-Step Rust Protection



3 Step Ball Bearing Slides



Combination Lock



**SIDE CABINET**

- Designed to fit on the side of a TengTools cabinet to create additional storage
- Fully lockable with a combination lock
- Five 75mm deep drawers and two 150mm deep drawers for storing large items
- When mounting to a cabinet with a back panel fitted a side plate (Item ID: TCW-SP01) must be used to install

	Width mm	Depth mm	Height mm	Capacity kg
Overall	382	460	795	
Drawer 1	288	380	75	30
Drawer 2	288	380	75	30
Drawer 3	288	380	75	30
Drawer 4	288	380	75	30
Drawer 5	288	380	75	30
Drawer 6	288	380	154	30
Drawer 7	288	380	154	30

Item ID: TCW-CAB01



Heavy Gauge Steel



5-Step Rust Protection



Combination Lock



**SIDE CABINET**

- Designed to fit on the side of a TengTools cabinet to create additional storage
- Fully lockable with a combination lock
- When mounting to a cabinet with a back panel fitted a side plate (Item ID: TCW-SP01) must be used to install
- 382(W)x460(D)x795(H) mm

Item ID: TCW-CAB03





\*Tools not included

### CARRYING CASE

- An empty carrying case for use with three TengTools TT tool trays
- The ideal way to create an individual, fully portable tool set
- Click lock and integral carrying handle
- The underside of the case is fitted with rubber feet to stop it sliding

Item ID: TC-3



### PORTABLE SERVICE CASE

- Space for up to 9 TengTools TT trays
- Hard wearing flight case style carrying case with a combination lock and secure catches
- Robust moulded body with built in strength and durability
- Complete with fixed castor wheels and retractable handle for easy carrying
- Handles on the end and side make it easy to carry
- Non slip rubber feet to prevent the case from sliding about
- Combination lock and snap tight catches keep the tools secure
- Designed to hold three TengTools TT trays in each of three compartments

Item ID: TC-SC



\*Tools not included

### CARRYING CASE

- An empty carrying case for use with four TengTools TT tool trays
- The ideal way to create an individual, fully portable tool set
- Click lock and integral carrying handle
- Supplied with shoulder straps to use as a back pack
- The underside of the case is fitted with rubber feet to stop it sliding

ITEM ID:	Description
TC-4	Portable carrying case
TC-4SBL	Spare straps



### MINI TOOL BOX

- Drop front with the TengTools logo to cover the drawers when the box is closed
- Drawers have ball bearing slides for a smoother and more reliable opening and closing action
- The underside of the box is fitted with rubber feet to prevent it from sliding
- Manufactured from heavy gauge top quality steel for rigidity and durability
- Powder coated with a 5 step rust prevention and undercoat to help prevent corrosion

	Width mm	Depth mm	Height mm	Capacity Kg	 kg
Overall	275	150	150		2.9
Drawer 1	215	130	38	5	
Drawer 2	215	130	38	5	

Item ID: TC103NF





**TOOL BOX**

- Plastic carrying case, ideal for carrying and storing tools
- Includes a tray with dividers for storing smaller items
- Double snap lock mechanism for a secure fit when closing the box

Item ID: TCP445C



**CANTILEVER TOOL BOX**

- A professional quality box with 5 individual storage areas
- Carrying handle designed to fold to the sides to enable easy access to the tools
- Padlock facility and full length piano hinges with turned edges for added safety

ITEM ID:	Description
TC540	Cantilever Tool Box
TC-540W	4x wheels for the cantilever tool box



**BARN STYLE TOOL BOX**

- Complete with aluminium clip rails for storing sockets
- 30 each of 1/4", 3/8" and 1/2" drive socket clips included
- A lift out tool tray and tool storage areas provide extra space
- Carrying handle designed to fold to one side to enable easy access
- Padlock facility and full length piano hinges with turned edges for added safety

Item ID: TC450



**TOOL BACK PACK**

- Specifically designed for carrying tools
- Use the shoulder straps as a back pack or the carrying handles as a carrying bag
- Manufactured in polyester with EVA plastic base for durability
- Includes various external pockets for small tools

Item ID: TCSB



**TOOL BAG**

- Specifically designed for carrying tools
- Use the shoulder strap or the robust aluminium carrying handle with an ergonomic grip
- Includes various pockets and holders for storing tools

Item ID: TCSB16



**TOP BOX COVER**

- Protective cover with the TengTools logo
- Fits TengTools standard size top boxes with 3, 4 or 6 drawers

Item ID: TC-COVER



**ROLLER CABINET COVER**

- Protective cover with the TengTools logo
- Fits TengTools standard size width and height roller cabinets

Item ID: TC-WC02



**STACK SYSTEM COVER**

- Protective cover with the TengTools logo
- Fits TengTools stack system using standard size top boxes, middle boxes & roller cabinets

Item ID: TC-COVER1



**NON SLIP MAT**

- Rubber mat for placing in tool boxes or tool box drawers
- 2mm thick to protect the tool box paint work
- Can also be used on work surface areas such as cabinet tops and work tops
- Resistant to oil and grease making it ideal for most workshops
- Simply cut to the required shape and size
- Supplied as a 2 meter x 45cm roll

Item ID: TC-MAT



**TOOL CABINET TOP TRAY**

- ABS tray designed to fit the top of TengTools standard width (26"/660mm) cabinets
- Individual parts areas plus positioning for a middle box or top box to give a very organised work area
- Protects the top of the roller cabinet from scratches and marks

Item ID: ABS-TOP

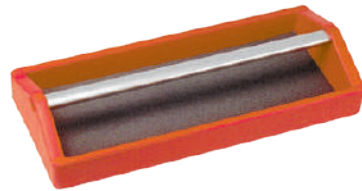

**TOTE TRAY**

- Plastic tray with an aluminium handle for lighter weight
- Fitted with rubber feet on the base for less risk of scratching
- Rubber mat included to stop tools sliding around when being carried
- Helps keep tools and components close to hand and organised

Item ID: TCA05



**BRACKETS FOR MIDDLE BOXES**

- Designed to secure a TengTools middle box to a TengTools cabinet
- Simply bolts to the middle box and clips on to the roller cabinet lip
- Prevents the middle box from tipping when moving the stack system

Item ID: TCF01



**BRACKETS FOR TOP BOXES**

- Designed to secure a TengTools top box to a TengTools cabinet
- Simply bolts to the top box and clips on to the roller cabinet lip
- Prevents the top box from tipping when moving the stack system

ITEM ID:	Suitable for	No. of Pieces
TCF02	Standard size top boxes	2
TCF03	53" extra wide top box	2

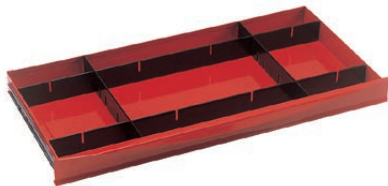

**4 PIECE DIVIDER SET**

- Interlocking black metal dividers for use in top box size drawers
- A simple way to create a drawer with 9 separate compartments

Item ID: TCDIVS



**4 PIECE DIVIDER SET**

- Interlocking black metal dividers for use in roller cabinet size drawers
- A simple way to create a drawer with 9 separate compartments

Item ID: TCDIVL



**MAGNETIC SIDE SHELF**

- Creates extra storage quickly and easily with no drilling required
- Can be easily fitted to any flat ferrous material surface
- Powerful magnets for secure fixing
- Ideal for using on the side of a tool cabinet

ITEM ID:	Width mm	Depth mm	Height mm	No. of magnets	 g
580K	230	98	136	2	625
580M	460	98	136	4	1194
580N	640	98	136	6	1232



**MAGNETIC SIDE SHELF**

- Magnetic side shelf for storing bottles and cans
- Creates extra storage quickly and easily with no drilling required
- Can be easily fitted to any flat ferrous material surface
- Powerful magnets for secure fixing
- Ideal for using on the side of a tool cabinet

ITEM ID:	Width mm	Depth mm	Height mm	No. of Can Holders	 g
580CK	230	98	136	2	625
580CM	460	98	136	4	1194
580CN	640	98	136	6	1232

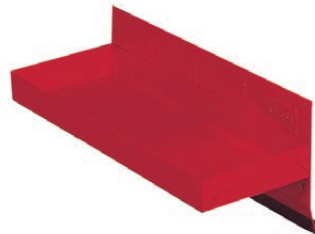

**MAGNETIC SIDE SHELF**

- Creates extra storage quickly and easily with no drilling required
- Can be easily fitted to any flat ferrous material surface
- Powerful magnets for secure fixing
- Ideal for using on the side of a roller cabinet

ITEM ID:	Width mm	Depth mm	Height mm
580C	310	115	31
580D	210	115	31



**MAGNETIC SIDE SHELF**

- Creates extra storage quickly and easily with no drilling required
- Can be easily fitted to any flat ferrous material surface
- Powerful magnets for secure fixing
- Ideal for using on the side of a roller cabinet

ITEM ID:	Width mm	Depth mm	Height mm
580J	410	90	100

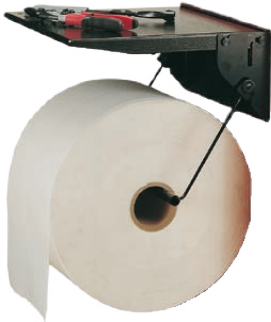

**SIDE TABLE AND PAPER ROLL HOLDER**

- Designed to fit on to the side of TengTools cabinets (fixings included)
- Fold out side tray (370 x 370mm) to create an additional working area
- Fixing bar for paper rolls up to 360mm width (paper roll not included)

Item ID: TCA01



**SIDE TABLE FOR MOUNTING A VICE**

- Designed to fit on to the side of TengTools cabinets (fixings included)
- Side shelf has fixing holes for the TengTools 4" vice (TCAV4)

Item ID: TCA TV



**WORKBENCH VICE**

- Forged steel 4" (100mm)
- Interchangeable parallel jaws and removable V shaped jaws for holding pipes and tubes
- High wear resistance with S45S steel (HRC45-50 hardness) for durability and strength
- Maximum clamping force of 300kg/cm<sup>2</sup> to grip most items tightly

Item ID: TCAV4



**SIDE PLATE**

- Designed to fit on the side of a TengTools regular height tool cabinet
- Creates an additional storage area for hanging tools or adding hook in accessories
- Supplied with a carrying handle and a fold out leg to create a free standing tool storage unit
- Dimensions: 460x640mm

Item ID: TCW-SP





### SIDE PLATE

- Designed to fit on the side of a TengTools regular height tool cabinet
- Creates an additional storage area for hanging tools or adding hook in accessories
- Dimensions: 805(H)x4560(W)x25(D)mm

Item ID: **TCW-SP01**



### HOOKS FOR SIDE PLATES AND PANELS

- Hooks for use with TengTools panels with square holes
- Screw fixing to fix the hook securely in place
- Ideal for hanging tools on a work station panel or a side plate on a roller cabinet

ITEM ID:	Description
TCW-HK10	7 x 90°, 3 x 45° hooks
TCW-HK02	10 double hooks
TCW-HK20	4 x 45° single, 4 x 45° double hooks, 4 x 90° single, 4 small and 4 large spring clips
TCW-HK45	10 45° hooks for TCW-SP side plate
TCW-HK90	10 90° hooks for TCW-SP side plate
TCW-HK03	TCW-HK90 x6, TCW-HK45 x6, TCW-HK02 x8



### SOCKET CLIP RAIL SET

- Four track aluminium section together with carrying handles
- 450mm overall length to fit in most tool boxes
- Supplied with 10 each socket clips in 1/4", 3/8" and 1/2" drive

Item ID: **ALU450**



### SOCKET CLIP RAILS

- Aluminium section for mounting on the wall or in a tool box
- For use with TengTools socket clips in 1/4", 3/8", 1/2" or 3/4" drive

ITEM ID:	Description
ALU430	430mm single track socket rail
ALU1000-1	1 metre single track socket rail
ALU1000-4	1 metre four track socket rail



### SOCKET CLIPS

- Packs of 10
- For storing sockets and accessories on clip rails

ITEM ID:	Description
ALU14	10 x 1/4" drive socket clips
ALU38	10 x 3/8" drive socket clips
ALU12	10 x 1/2" drive socket clips
ALU34	10 x 3/4" drive socket clips



**MAGNETIC TOOL RAIL**

- 6 individual magnets each with a capacity of 450g
- Designed to fix to the side of TengTools roller cabinets
- Also suitable for wall mounting or for use with other tool boxes
- Ideal for hanging up tools while working

Item ID: **TC-MAG**



**WOOKTOPS FOR TOOL CABINETS**

- 37mm thick work tops in hard wearing laminated wood
- Three sizes available to suit different roller cabinets

ITEM ID:	Length mm	Depth mm	Thickness mm	Suitable for
TC-TB02	672	460	37	TCW803N, TCW804N, TCW806N, TCW806N1, TCW807N, TCW808N, TCW810N, TCW707EV, TCW907X
TC-TB03	948	460	18	TCW207N
TC-TB01	1354	460	37	TCW806LN, TCW809N



**HANDLES FOR TOP & MIDDLE BOXES**

- A pair of side handles with soft grip for use with TengTools top boxes and middle boxes

Item ID: **TCDSH**



**HANDLE FOR TOOL CABINETS**

- Side handle for TengTools roller cabinets
- The soft grip handle gives improved comfort

Item ID: **TCRFH**



**TOOL CABINET CASTOR WHEELS**

- A set of four 5" (125mm) black castors with needle bearings
- 2" wide wheels give extra strength and stability
- Capacity of 170 kilos per castor or 500 kilos for the set of four
- Ideal for upgrading a TengTools roller cabinet for heavier use
- Two fixed and two swivel wheels with 2 stage brakes in the set

Item ID: **TCNBC**

**TOOL BOX TRANSPORT TROLLEY**

- Frame with a set of 4 wheels for TengTools regular top boxes
- Creates a mobile tool box
- Especially useful if the tool box is heavily laden with tools

Item ID: TCTMC

**SIDE CABINET TRANSPORT TROLLEY**

- Frame with a set of 4 wheels for TengTools side cabinets
- Creates a mobile tool box or storage unit
- Especially useful if the cabinet is heavily laden

Item ID: TCSMC

**THREE LOCK SET**

- Set of 3 key type locks for TengTools tool boxes
- One common key number
- Enables a stack system to be converted to have one common key on all locks

Item ID: TC-LOCK3

**FIVE LOCK SET**

- Set of five key type locks for TengTools tool boxes
- One common key number
- Enables a stack system to be converted to have one common key on all locks

Item ID: TC-LOCK5

**BLANK KEY**

- Blank key for TengTools key type locks
- For creating replacement keys

Item ID: TC-BKEY



## Which lock to choose?



### Key Locks

ITEM ID:
TCDRK
TCPRK

Tool Box	Description	Lock
TC806SV	6 drawer top box	TCPRK
TC803SV	3 drawer middle box	TCDRK
TCW707EV	7 drawer roller cabinet	TCDRK
TCW-CAB	Side cupboard	TCPRK



### Combination Locks

ITEM ID:
TC-90CLOCK
TC-180CLOCK

Tool Box	Description	Lock
TC805NFX	5 drawer top box	TC-90CLOCK
TC806NF	6 drawer top box	TC-90CLOCK
TC806NGM	6 drawer top box	TC-90CLOCK
TC803N	3 drawer middle box	TC-180CLOCK
TC803NBK	3 drawer middle box	TC-180CLOCK
TCW803N	3 drawer roller cabinet	TC-180CLOCK
TCW803N	Storage compartment	TC-90CLOCK
TCW804N	4 drawer roller cabinet	TC-180CLOCK
TCW806N	6 drawer roller cabinet	TC-180CLOCK
TCW806N1	6 drawer roller cabinet	TC-180CLOCK
TCW807N	7 drawer roller cabinet	TC-180CLOCK
TCW810N	10 drawer roller cabinet	TC-180CLOCK
TCW810NBK	10 drawer roller cabinet	TC-180CLOCK
TC810N	10 drawer double width top box	TC-90CLOCK
TCW207N	7 drawer 37" wide roller cabinet	TC-180CLOCK
TCW806LN	6 drawer double width roller cabinet	TC-180CLOCK
TCW809N	9 drawer double width roller cabinet	TC-180CLOCK
TCW-CAB01	Side cabinet	TC-180CLOCK
TCW-CAB02	Side cabinet	TC-180CLOCK
TCW-CAB03	Side cabinet	TC-90CLOCK





# RACKING SYSTEM

THE ULTIMATE GARAGE OR WORKSHOP



Combination locking system so you can rest assured the contents are safe



Back panels ideal for hanging tools and equipment keeping them within arms reach of your workspace

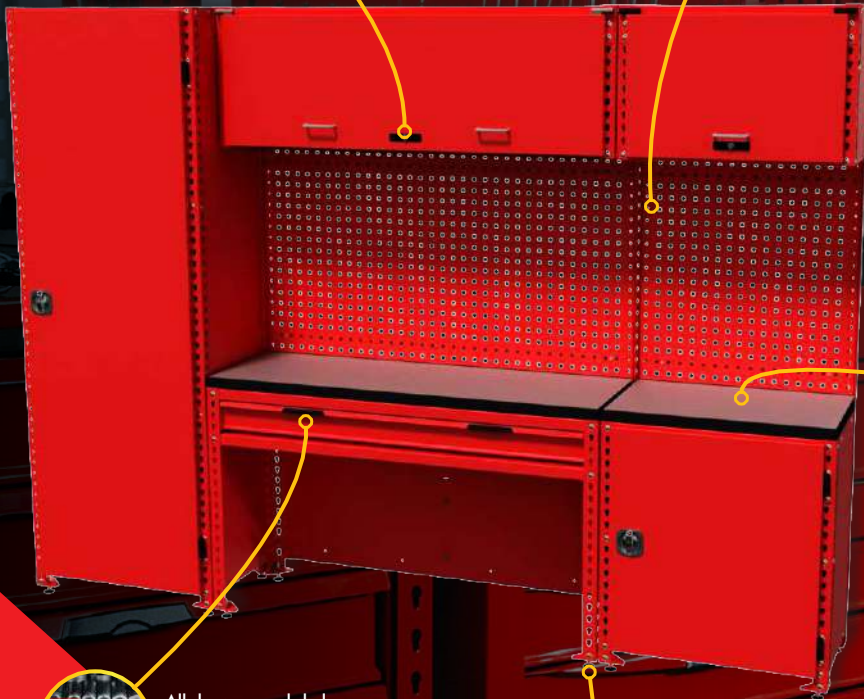

Double high density laminated work surface that is durable and easy to clean



All drawers and shelves are built to last! They can handle the demands of any busy workshop



Supplied with adjustable legs to keep your work surface level and steady





**XL**

## EXTRA LARGE MODULE

- Includes tool panels, base units with a work top and 2 wall cabinets
- Also includes a floor standing cupboard with shelves and 8 tool drawers
- A complete storage solution for the workshop
- Use on it's own or extend it further using the TengTools modular racking system

**NEW**



2 Drawer modules that include 8 individual drawers supplied as standard

- 9 Drawer
- Heavy Gauge Steel
- 5-Step Rust Protection
- 3 Step Ball Bearing Slides
- Combination Lock

Item ID: RSMXL

**L**

## LARGE MODULE

- Includes tool panel, base unit with a drawer and a work top and a wall cabinet
- Also includes a floor standing cupboard with shelves and 8 tool drawers
- A complete storage solution for the workshop
- Use on it's own or extend it further using the TengTools modular racking system

**NEW**



2 Drawer modules that include 8 individual drawers supplied as standard

- 9 Drawer
- Heavy Gauge Steel
- 5-Step Rust Protection
- 3 Step Ball Bearing Slides
- Combination Lock

Item ID: RSML

**NEW**



2 Drawer modules that include 8 individual drawers supplied as standard

**M**

**MEDIUM MODULE**

- Includes tool panel, base unit with a work top as well as a wall cabinet
- Also includes a floor standing cupboard with shelves and 8 tool drawers
- A complete storage solution for the workshop
- Use on it's own or extend it further using the TengTools modular racking system



**8**

**Drawer**



**Heavy Gauge Steel**



**5-Step Rust Protection**



**3 Step Ball Bearing Slides**



**Combination Lock**

Item ID: **RSMM**

**NEW**



2 Drawer modules that include 8 individual drawers supplied as standard

**S**

**SMALL MODULE**

- Includes a lockable floor standing cupboard with shelves and 8 tool drawers
- A secure storage solution for the workshop
- Use on it's own or extend it further using the TengTools modular racking system

**8**

**Drawer**



**Heavy Gauge Steel**



**5-Step Rust Protection**



**3 Step Ball Bearing Slides**



**Combination Lock**



Item ID: **RSMS**



- Heavy Gauge Steel
- 5-Step Rust Protection
- Combination Lock

**NEW**



## BASE MODULE

- Includes uprights, tool panel, base unit with a work top and a wall cabinet
- The ideal starting pack to build a work station
- Use on it's own or as part of the TengTools modular racking system

ITEM ID	Height mm	Height (Kickplate) mm	Width mm	Depth mm	Base Unit
RSMB0700	2030-2055	2095-2120	700	475	Empty
RSMB0800	2030-2055	2095-2120	800	475	Empty
RSMB1340	2030-2055	2095-2120	1340	475	Empty

- Heavy Gauge Steel
- 5-Step Rust Protection
- Combination Lock
- Key Lock

**NEW**



## BASE CABINET MODULE

- Includes uprights, tool panel, base unit with a work top and a wall cabinet
- Includes secure storage area with shelves & a lockable door
- The ideal starting pack to build a work station
- Use on it's own or as part of the TengTools modular racking system

ITEM ID	Height mm	Height (Kickplate) mm	Width mm	Depth mm	Base Unit
RSMC0700	2030-2055	2095-2120	700	475	Shelf Cabinet
RSMC0800	2030-2055	2095-2120	800	475	Shelf Cabinet
RSMC1340	2030-2055	2095-2120	1340	475	Shelf Cabinet

- Heavy Gauge Steel
- 5-Step Rust Protection
- Combination Lock
- 3 Step Ball Bearing Slides

**NEW**



## SINGLE DRAWER MODULE

- Includes uprights, tool panel, base unit with a drawer and a work top as well as a wall cabinet
- The ideal starting pack to build a work station
- Use on it's own or extend it further using the TengTools modular racking system

ITEM ID	Height mm	Height (Kickplate) mm	Width mm	Depth mm	Base Unit
RMSD0700	2030-2055	2095-2120	700	475	Single Drawer
RMSD1340	2030-2055	2095-2120	1340	475	Single Drawer

- Heavy Gauge Steel
- 5-Step Rust Protection
- Combination Lock
- 3 Step Ball Bearing Slides

**NEW**



## 4 DRAWER MODULE

- Includes a drawer unit with 4 drawers to create an organised storage area
- The ideal starting pack to build a work station
- Use on it's own or as part of the TengTools modular racking system

ITEM ID	Height mm	Height (Kickplate) mm	Width mm	Depth mm	Base Unit
RSMFD0700	2030-2055	2095-2120	700	475	4 Drawer
RSMFD1340	2030-2055	2095-2120	1340	475	4 Drawer





Heavy Gauge Steel



5-Step Rust Protection



Key Lock



### FULL HEIGHT CABINET

- Use on it's own or as part of the TengTools modular racking system
- Adjustable feet for use on uneven floors
- Can be used with the TengTools kick plate to raise the height
- Includes 4 shelves and a lockable door

ITEM ID	Height mm	Height (Kickplate) mm	Width mm	Depth mm	Number of Shelves
RSCH700450	2030-2055	2095-2120	700	475	4
RSCH800450	2030-2055	2095-2120	800	475	4
RSCH1340450	2030-2055	2095-2120	1340	475	4



Heavy Gauge Steel



5-Step Rust Protection



Key Lock



### CORNER CABINET

- Use on it's own or as part of the TengTools modular racking system
- Adjustable feet for use on uneven floors
- Can be used with the TengTools kick plate (RSTKPCC) to raise the height
- Includes 4 shelves and a lockable door

ITEM ID	Height mm	Height (Kickplate) mm	Width mm	Depth mm	Number of Shelves
RSCCH800	2030-2055	2095-2120	800	800	4



Heavy Gauge Steel



5-Step Rust Protection



Key Lock



### FLOOR STANDING CABINET

- Use on it's own or as part of the TengTools modular racking system
- Adjustable feet for use on uneven floors
- Can be used with the TengTools kick plate to raise the working height
- Can be used with the TengTools work top to create a workbench
- Includes three shelves and a lockable door

ITEM ID	Height mm	Height (Kickplate) mm	Height (Kickplate & Worktop) mm	Width mm	Depth mm
RSC700450	800-825	865-890	900-925	700	475
RSC800450	800-825	865-890	900-925	800	475
RSC1340450	800-825	865-890	900-925	1340	475



Heavy Gauge Steel



5-Step Rust Protection



Combination Lock



### WALL CABINET

- Use on it's own or as part of the TengTools modular racking system
- Designed to fix to the TengTools wall racking uprights
- Includes 2 shelves and a drop down lockable door

ITEM ID	Height mm	Width mm	Depth mm	Number of Shelves
RSCW700300	460	700	300	2
RSCW800300	460	800	300	2
RSCW1340300	460	1340	300	2



Heavy Gauge Steel



5-Step Rust Protection



### SHELVING UNIT MODULE

- Easy to assemble sturdy racking unit
- Use on it's own or as part of the TengTools modular racking system
- Adjustable feet for use on uneven floors
- Includes 4 shelves that can be positioned at any height

ITEM ID	Height mm	Width mm	Depth mm	Max Load per shelf kg
RSK0700	2000	700	450	300
RSK0800	2000	800	450	300
RSK1350	2000	1350	450	160



Heavy Gauge Steel



5-Step Rust Protection



3 Step Ball Bearing Slides



### SHELVING & DRAWER UNIT

- Easy to assemble sturdy racking unit
- Includes a 4 drawer module
- Use on it's own or as part of the TengTools modular racking system
- Adjustable feet for use on uneven floors
- Includes 2 regular shelves and a sliding shelf that can be positioned at any height

ITEM ID	Height mm	Width mm	Depth mm	Max Load per shelf kg
RSK0700A	2000	700	450	300
RSK1350A	2000	1350	450	160



Heavy Gauge Steel



5-Step Rust Protection



### CORNER SHELVING MODULE

- Easy to assemble sturdy racking unit
- Use on it's own or as part of the TengTools modular racking system
- Adjustable feet for use on uneven floors
- Includes 4 shelves that can be positioned at any height

ITEM ID	Height mm	Width mm	Depth mm	Max Load per shelf kg
RSKC02	2000	800	800	300



Heavy Gauge Steel



5-Step Rust Protection



3 Step Ball Bearing Slides



Castor Wheels with Brakes



### MOBILE TROLLIES

- Mobile trolley
- A mobile work trolley with shelves and a drawer
- Two fixed castors and two swivelling castors with brakes
- Two shelves and a ball bearing slide drawer
- Ideal for moving parts and equipment around the work place

ITEM ID	Height mm	Height (Wheels) mm	Width mm	Depth mm
TR070	770	932	700	450
TR135	770	932	1339	450



Heavy Gauge Steel



5-Step Rust Protection



3 Step Ball Bearing Slides



**DRAWER MODULES**

- Designed for use with the TengTools modular racking system
- Four drawers with ball bearing slides
- Drawers designed for use with the TengTools Get Organised system

ITEM ID	Height mm	Width mm	Depth mm
RSD070004	310	603	378
RSD135004	413	1215	378



Heavy Gauge Steel



5-Step Rust Protection



**RACKING SYSTEM SHELVES**

- Fixed shelf for use as part of the TengTools modular racking system

ITEM ID	Item	Height mm	Width mm	Depth mm
RSS0700	Shelf	35	698	445
RSS0800	Shelf	35	795	445
RSS1350	Shelf	35	1335	445
RSTSB	Brackets (x4)	For fixing shelves at an angle		



Heavy Gauge Steel



5-Step Rust Protection



**RACKING SYSTEM CORNER SHELF**

- Corner shelf for use as part of the TengTools modular racking system

ITEM ID	Item	Height mm	Width mm	Depth mm
RSSC01	Shelf	35	795	795



Heavy Gauge Steel



5-Step Rust Protection



**RACKING SYSTEM SLIDING SHELVES**

- Sliding shelf for use as part of the TengTools modular racking system

ITEM ID	Height mm	Width mm	Depth mm
RSSS700	22.5	583	430
RSSS1350	22.5	1223	430



Heavy Gauge Steel



5-Step Rust Protection



**KICK PLATES**

- Raises the height of the unit
- Especially designed for use with TengTools floor standing cabinets
- Fully adjustable feet to compensate for uneven floors

ITEM ID	Suitable for:	Width mm
RSTKP700	700mm wide floor standing cabinet	700
RSTKP800	800mm wide floor standing cabinet	800
RSTKP1340	1340mm wide floor standing cabinet	1340
RSTKPCC	800mm corner cabinet	800



**WORK TOPS**

- Manufactured in hard wearing double density 37mm thickness board
- Laminated and finished with an edging strip to create a work top that is hard wearing and easy to keep clean

ITEM ID	Length mm	Depth mm	Height mm
RSWB0700	696	443	37
RSWB0800	792	443	37
RSWB1340	1332	443	37



Heavy Gauge Steel

5-Step Rust Protection

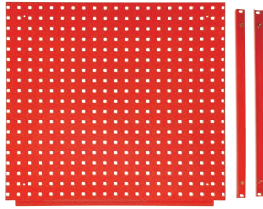

## TOOL PANELS

- Designed to fit to the TengTools modular wall racking uprights
- Use with TengTools hooks, wall racks and shelves for extra storage

ITEM ID	Height mm	Width mm
RSTP0700	730	682
RSTP0800	730	779
RSTP1340	730	1319



## RACKING SYSTEM SPARE PARTS

ITEM ID:	Description
RSE0700	Blank EVA Drawer filler - Width 700mm
RSE0800	Blank EVA Drawer filler - Width 800mm
RSE1340	Blank EVA Drawer filler 2x of these required to fill 1340mm drawer
RS72	Racking system spacer
RSRU01N	2 meter upright with foot



## INDUSTRIAL QUALITY WORKBENCHES

- Sturdy, laminated granite effect work surface with black edging
- Adjustable legs to give a working height of between 707 & 927mm

ITEM ID	Length mm	Depth mm	kg
TWB1500	1500	800	53
TWB2000	2000	800	69

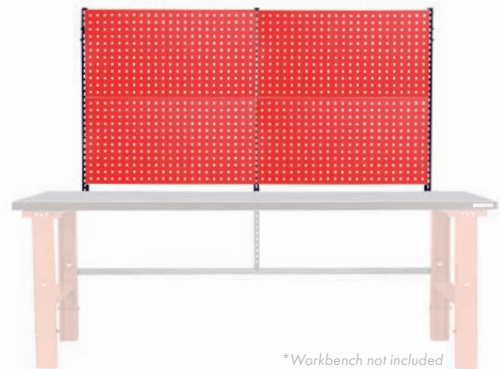

*\*Workbench not included*

## WORKBENCH PANEL KIT

- A panel kit complete with uprights and fixings for use with the TengTools workbench
- Converts a workbench into a work station
- Uses the TengTools square hole system for use with a wide range of hooks and accessories

ITEM ID	Suitable for	Width mm	No. of Panels
TWB-1500A	TWB1500	1500	2
TWB-2000A	TWB2000	2000	4



## WORKBENCH SPARE PARTS

ITEM ID:	Description
TWB-1STOP	workbench Work Top 1500mm
TWB-20TOP	workbench Work Top 2000mm
TWB-4WD	workbench Wheel Set
TWB-LEG	workbench Legs 2 Pieces
TWB-PA	workbench Panel
TWB-UPR	workbench Upright
TWB-15SQ	workbench Spare 9 Hole Square Tube





**Convert your cabinet into a  
WORKSTATION**



\*Tool Cabinet not included



\*Tool Cabinets not included

**WORK STATION PANEL SET**

- Preconfigured pack including panels, uprights, fixing bars, a header and a work top
- Designed to fit on top of TengTools cabinets
- Creates a single width work station

ITEM ID	Suitable for
TC-S01	Standard Size Tool Cabinets
TC-SL01	53" Wide Tool Cabinets

**WORK STATION ADD-ON PANEL SET**

- Preconfigured pack including panels, brackets, fixing bars, a header and a work top
- Designed to fit with a TengTools cabinet when a panel set has already been installed
- Creates a double width work station

ITEM ID	Suitable for
TC-S02	Standard Size Tool Cabinets
TC-SL02	53" Wide Tool Cabinets



\*Tool Cabinet not included

## WORK STATION LEFT/RIGHT ADD-ON PANEL SET

- Preconfigured pack including panels, brackets, fixing bars, a header, a work top and a side leg
- Designed to fit with a TengTools cabinet when a panel set has already been installed
- Creates a double width work station

ITEM ID	Suitable for	Side
TC-S03AL	Standard Size Tool Cabinets	Left Add-on
TC-SL03AL	53" Wide Tool Cabinets	Left Add-on
TC-S03AR	Standard Size Tool Cabinets	Right Add-on
TC-SL03AR	53" Wide Tool Cabinets	Right Add-on



Heavy Gauge Steel



5-Step Rust Protection



Combination Lock



## WALL HANGING TOOL CABINET

- Panels have square peg holes for use with the range of TengTools hooks
- Ideal for use with workbenches or on top of any standard width TengTools roller cabinet

ITEM ID	Width mm	Height mm	Depth mm	kg
TCB80	660	600	305	15
TCB80A	660	600	455	16.5



Heavy Gauge Steel



5-Step Rust Protection



Combination Lock



## WALL HANGING TOOL CABINET

- Designed for wall mounting, heavy duty mounting brackets included
- Peg board included on the inner back of the cabinet and on the inner side of the doors
- Ideal for use with workbenches to create a self contained working area

ITEM ID	Width mm	Height mm	Depth mm	kg
TCB80C	820	900	250	24



Heavy Gauge Steel



5-Step Rust Protection



Combination Lock

## WALL HANGING TOOL CABINET

- Inside panel has square peg holes for use with the range of TengTools hooks
- Designed for wall mounting, heavy duty mounting brackets included
- Ideal for use with workbenches to create a self contained working area

ITEM ID	Width mm	Height mm	Depth mm	kg
TCB135	1335	700	200	35.75



Heavy Gauge Steel



5-Step Rust Protection



Combination Lock

### WALL HANGING TOOL CABINET

- Inside panel has square peg holes for use with the range of TengTools hooks
- Designed for wall mounting, heavy duty mounting brackets included
- Ideal for use with workbenches to create a self contained working area

ITEM ID	Width mm	Height mm	Depth mm	kg
TCB180	1800	700	200	50



### WORK STATION SPARE PARTS

ITEM ID:	Description
TC-LBK	L Brackets 2pcs
TC-LEG	Support Leg
TC-FB01	664mm Fixing Bar
TC-FB02	1353mm Fixing Bar
TC-H01	670mm Header
TC-H02	1380mm Header
TC-PA01	665mm Panel
TC-PA02	1370mm Panel
TC-UPRL	Left Upright Long
TC-UPRR	Right Upright Long
TC-160UR	Uprights 1.6m 2pcs
TC-FB03	916mm Fixing Bar
TC-PA03	Panel for TCW207N
TC-H05	950mm Header
TC-UPRLS	LHS Upright Short
TC-UPRRS	RHS Upright Short
TWB-20SQ	7 Hole Square Tube
TC-H03	1.5m Header
TC-H04	0.5m Header
TWB-FB	Fixing Bar 875mm



### HOOK ON TRAYS

- Parts tray for tool panels
- Designed to hook in to the square holes on TengTools panels and
- Ideal for storing accessories, components, small tools, etc.

ITEM ID	Width mm	Depth mm	Height mm	g
TCT01	230	101	139	450
TCT02	460	101	140	846
TCT03	640	103	141	1138

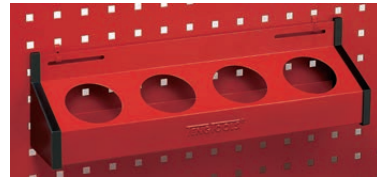

### HOOK ON CAN HOLDER

- Aerosol can holder for tool panels
- Designed to hook in to the square holes on TengTools panels
- Ideal for storing aerosol cans, bottles, etc.

ITEM ID	Width mm	Depth mm	Height mm	No. of Can Holders	g
TCC01	230	98	136	2	448
TCC02	460	99	137	4	831
TCC03	640	100	138	6	1128



\*T-bar not included

### HOOK ON TOOL HOLDER

- Hook tool holder for tool panels
- Designed to hook in to the square holes on TengTools panels
- Ideal for storing tools such as T bars etc

Item ID: TCT04



## LED LIGHT BAR

- 255mm wide light bar with 9 built in white LED lights
- 120 light distribution angle to illuminate a wide area
- Magnetic attachment for fixing quickly and simply with no drilling required
- Requires 3 AA batteries (not included)
- Ideal for use with workbenches as a light source

Length mm	Width mm	Height mm	Light Lumen	Magnetic Pull Nm	Weight g
255	40	29	20	30 x2	188

Item ID: 587J



## LED WORK LIGHT

- 660mm wide light bar with 80 built in white LED lights
- 7.2 watts (2,040 lumen) to give a powerful light source
- Magnetic attachment for fixing quickly and simply with no drilling required
- Ideal for use with workbenches as a light source

ITEM ID	Region
589ME	Europe
589MU	UK
589MA	Aus / NZ



## HOOKS FOR SIDE PLATES AND PANELS

- Hooks for use with TengTools panels with square holes
- Screw fixing to fix the hook securely in place
- Ideal for hanging tools on a work station panel or a side plate on a roller cabinet

ITEM ID:	Description
TCW-HK10	7 x 90°, 3 x 45° hooks
TCW-HK02	10 double hooks
TCW-HK20	4 x 45° single, 4 x 45° double hooks, 4 x 90° single, 4 small and 4 large spring clips
TCW-HK45	10 45° hooks for TCW-SP side plate
TCW-HK90	10 90° hooks for TCW-SP side plate
TCW-HK03	TCW-HK90 x6, TCW-HK45 x6, TCW-HK02 x8



Heavy Gauge Steel



5-Step Rust Protection



\*Tool Cabinet not included

## TOOL PANEL SET FOR TCW207N

- Preconfigured pack including panels, fixing bar, a header and uprights
- Designed to fit on top of an extra wide 37" TengTools roller cabinet
- Creates an extra wide single width work station with a high level back panel

ITEM ID	Suitable for	Number of Panels
TC-S03	TCW207N	2
TC-S04	TCW207N	1





Heavy Gauge Steel



5-Step Rust Protection



33 Pieces

**PORTABLE WORK STATION WITH TOOLS**

- Portable work station with tools
- A single sided portable work station (TPM01) supplied with tools
- Includes four wall rack sets covering screwdrivers, pliers, spanners and T handle hex keys
- The ideal movable tool station for use around the work place

Contents	
Item ID	Description
WRMD910N	10 Piece Screwdriver Wall Rack
WRMB04	4 Piece Plier Wall Rack
WRSP12	12 Piece Combination Spanner Wall Rack
WRHEX07	7 Piece T Handle Hex Key Wall Rack

Item ID: **TPM01**



Heavy Gauge Steel



5-Step Rust Protection



**PORTABLE TOOL PANELS**

- The ideal way to store tools when they need to be moved around the work place
- The unit is 1.6m tall on castors
- Tool panels can be fitted to either side
- For use with TengTools wall racks and workbench accessories

ITEM ID	Front Panels	Back Panels
TPM01	2	0
TPM02	2	2



# GET ORGANISED

## MODULAR TOOL TRAY SYSTEM

1

Choose Your Storage



2

Choose Your Tool Trays



3

Click Together



When you think of organising your workplace or garage it can seem like a hassle, but when you 'Get Organised' with Teng Tools it allows you to work better, faster and saves you money.

The Get Organised System has become the preferred choice for key industrial users and top motor racing mechanics who recognise that organisation is key to efficiency and success. This concept allows you to build the ultimate tool kit in 3 simple steps: 1. Choose your storage, 2. Choose your tool trays, 3. Click together – Get Organised!



Tool trays are supplied with a removable plastic lid with click locks. This allows the set to be used on it's own or as a part of the Get Organised Tool Tray System





**GET ORGANISED**

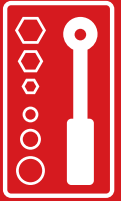

To use the trays in the Get Organised system you need to remove the lid by opening the click lock and pulling the lid out of the hinges



Once the lid is removed the tray can be inserted into the drawer of your chosen storage

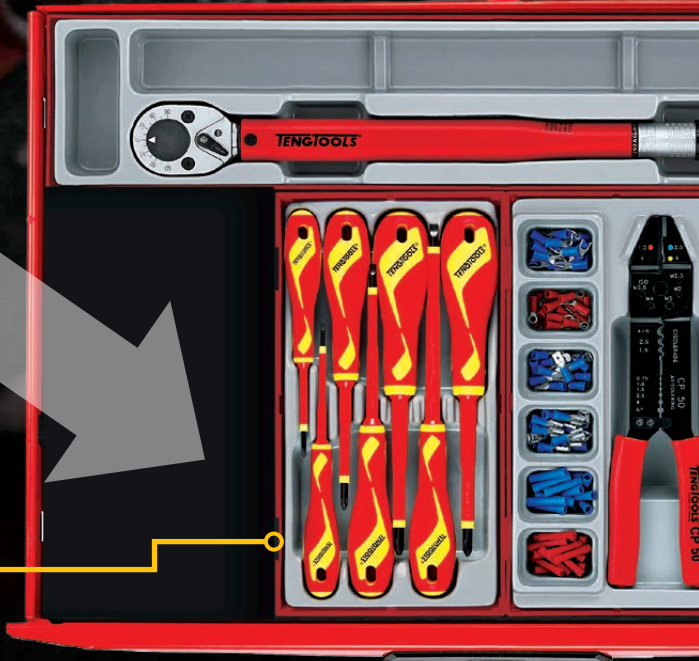

Each tool tray clicks together in the drawer securely storing your tools in an organised system





GET ORGANISED

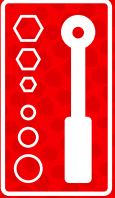

# BUILD THE ULTIMATE TOOL KIT





# Get organised



## HOW DO THE TRAYS FIT?

CHOOSE THE TOOL TRAY SIZE BELOW TO FIT THE SPACE IN YOUR STORAGE:

Storing tools in hard to reach places and in an illogical manner can disrupt the workflow of any garage or workshop. The unique Teng Tools Get Organised System uses tool trays that click together to fit perfectly into your chosen storage solution. You do not have to waste time searching for tools anymore.

Every tool has its own specific place in your toolbox. You can rest assured knowing that any tool you need is easy to find and ready for the task whenever you need it. This creates a more efficient workflow and gives you more time to do what you do best every day.

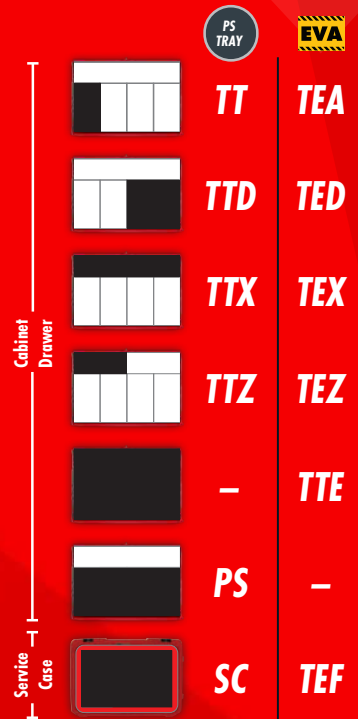



## Storage Trays



- Includes 2 clip rails and clips for 1/4", 3/8" and 1/2" drive sockets
- A protective mat is included in the bottom of the tray
- Removable lid and dove tail joints

2 x 260mm aluminium rails, 10 x 1/4" drive socket clips,  
10 x 3/8" drive socket clips, 10 x 1/2" drive socket clips

Item ID: TTALU



### STORAGE TRAY

- Includes plastic clips for holding spanners or screwdrivers
- A protective mat is included in the bottom of the tray
- Removable lid and dove tail joints

Item ID: TT00



### STORAGE TRAY

- Storage tray with 7 compartments
- Ideal for storing small components and consumables
- Removable lid and dove tail joints

Item ID: TT01



### STORAGE TRAY

- Storage tray with 2 compartments
- Ideal for storing small components and consumables
- Removable lid and dove tail joints

Item ID: TT02



### STORAGE TRAY

- Storage tray with 4 compartments
- Ideal for storing small components and consumables
- Removable lid and dove tail joints

Item ID: TT03



### STORAGE TRAY

- Storage tray with 6 compartments
- Ideal for storing small components and consumables
- Removable lid and dove tail joints

Item ID: TT04

**NEW**



Get organised!	
Tray Size	
TT	

**STORAGE TRAY**

- Empty tray for holding 4x TJ sets
- Removable lid and dove tail joints

Item ID: **TTTJ04**



Get organised!	
Tray Size	
	TTD

**STORAGE TRAY**

- Storage tray with 4 compartments
- Ideal for storing small components and consumables
- Removable lid and dove tail joints

Item ID: **TTD00**



Get organised!	
Tray Size	
	TTD

**STORAGE TRAY**

- Storage tray with 8 compartments
- Ideal for storing small components and consumables
- Removable lid and dove tail joints

Item ID: **TTD01**



Get organised!	
Tray Size	
	TTD

**STORAGE TRAY**

- Storage tray with 16 compartments
- Ideal for storing small components and consumables
- Removable lid and dove tail joints

Item ID: **TTD02**



Get organised!	
Tray Size	
	TTX

**STORAGE TRAY**

- Storage tray with 1 compartment
- Ideal for storing additional tools, components and consumables
- A protective mat is included in the bottom of the tray

Item ID: **TTX00**



Get organised!	
Tray Size	
	TTX

**STORAGE TRAY**

- Storage tray with 6 compartments
- Ideal for storing additional tools, components and consumables

Item ID: **TTX01**





## STORAGE TRAY

- Storage tray with 4 compartments
- Ideal for storing additional tools, components and consumables

Item ID: TTX02



## STORAGE TRAY

- Storage tray with 8 compartments
- Ideal for storing additional tools, components and consumables

Item ID: TTX03



## STORAGE TRAY

- Storage tray with 6 compartments
- Ideal for storing small components and consumables

Item ID: TTZ01

## General Tool Kits



## GENERAL TOOL SET

9 Pieces

- A selection of tools to compliment any tool kit
- Includes measuring, striking and cutting tools as well as an adjustable wrench and power grip pliers

### General Tools:

6" adjustable wrench, 10" adjustable wrench, 10" power grip plier, utility knife, 12" hack saw, soft face hammer, 3 meter tape measure, 200mm steel rule, 24oz (675g) ball pein hammer

Item ID: TTPS09



## GENERAL TOOL SET

9 Pieces

- A selection of tools to compliment any tool kit
- Includes measuring, striking and cutting tools as well as an adjustable wrench and power grip pliers

### General Tools:

6" adjustable wrench, 10" adjustable wrench, 10" power grip plier, utility knife, 12" hack saw, soft face hammer, 3 meter measuring tape, 200mm steel rule, 800g engineers hammer

Item ID: TTPS09E





Get organised!  
Tray Size  
**SC**

**SERVICE TOOL SET**

6 Pieces

- Especially designed for use in the TengTools TC-SC portable service case
- A set of general hand tools to compliment the other sets in a tool kit

General Tools:

Measuring tape, hacksaw frame, utility knife, power grip plier, adjustable wrench, ball pein hammer

Item ID: **SCPS01**



Get organised!  
Tray Size  
**SC**

**SERVICE TOOL SET**

6 Pieces

- Especially designed for use in the TengTools TC-SC portable service case
- A set of general hand tools to compliment the other sets in a tool kit

General Tools:

Measuring tape, hacksaw frame, utility knife, power grip plier, adjustable wrench, engineers hammer

Item ID: **SCPS01E**

**Socket Sets**



Get organised!  
Tray Size  
**TT**

**SOCKET SET**

1/4" DRIVE 35 Pieces **mm**

- Regular and deep 6 point single hexagon sockets
- Chrome vanadium satin finish sockets
- Designed and manufactured to DIN and ISO standards

72 Teeth ratchet, Universal Joint, 6" spinner handle

Coupler adaptor, 2" & 4" Extension bars, 3/8" F x 1/4" M T-bar adaptor

6 point sockets:

Reg mm:	4	5	5.5	6	7	8	9		
	10	11	12	13					
Deep mm:	6	7	8	10	12	13			
1/4" Hex bits:	-		4, 5.5	+		TPX10, TPX15, TPX20			5, 6
	+		PH1, PH2	+		PZ1, PZ2			

Item ID: **TT1435**

**NEW**



Get organised!  
Tray Size  
**TT**

**SOCKET SET**

1/4" DRIVE 35 Pieces **mm**

- Regular and deep 12 point bi-hexagon sockets
- Chrome vanadium satin finish sockets
- Designed and manufactured to DIN and ISO standards

72 Teeth ratchet, Universal Joint, 6" spinner handle

Coupler adaptor, 2" & 4" Extension bars, 3/8" F x 1/4" M T-bar adaptor

12 point sockets:

Reg mm:	4	5	5.5	6	7	8	9		
	10	11	12	13					
Deep mm:	6	7	8	10	12	13			
1/4" Hex bits:	-		4, 5.5	+		TPX10, TPX15, TPX20			5, 6
	+		PH1, PH2	+		PZ1, PZ2			

Item ID: **TT143512**



1/4" DRIVE 3/8" DRIVE 32 Pieces AF

## SOCKET SET

- Regular and deep 6 point single hexagon sockets
- Chrome vanadium satin finish sockets
- Designed and manufactured to DIN3120/3124 and ISO2725

3/8" Drive 6 point sockets:									
Reg AF:	3/8	7/16	1/2	9/16	5/8	11/16	3/4		
Deep AF:	3/8	7/16	1/2	9/16	5/8	11/16	3/4		
1/4" Drive 6 point sockets:									
Reg AF:	3/16	7/32	1/4	9/32	5/16	11/32	3/8	7/16	1/2
Deep AF:	3/16	7/32	1/4	9/32	5/16	11/32	3/8	7/16	1/2

Item ID: TTAF32

**NEW**



1/4" DRIVE 3/8" DRIVE 32 Pieces AF

## SOCKET SET

- Regular and deep 12 point bi-hexagon sockets
- Chrome vanadium satin finish sockets
- Designed and manufactured to DIN3120/3124 and ISO2725

3/8" Drive 12 point sockets:									
Reg AF:	3/8	7/16	1/2	9/16	5/8	11/16	3/4		
Deep AF:	3/8	7/16	1/2	9/16	5/8	11/16	3/4		
1/4" Drive 12 point sockets:									
Reg AF:	3/16	7/32	1/4	9/32	5/16	11/32	3/8	7/16	1/2
Deep AF:	3/16	7/32	1/4	9/32	5/16	11/32	3/8	7/16	1/2

Item ID: TTAF3212

**NEW**



1/4" DRIVE 48 Pieces mm

## SOCKET SET

- Gearless palm ratchet, 3" extension bar
- 1/4" drive regular 6 point sockets 5-13mm
- A selection of 25mm & 89mm long bits

Gearless palm ratchet, 3" extension bar											
6 point sockets:											
Reg mm:	5	5.5	6	7	8	9	10	11			
	11	12	13								
1/4" Hex bits:											
Length 25mm	⊖	3.5, 5.5, 8	⊕	PZ1, PZ2, PZ3	⊗	2, 3, 4, 5, 6, 8					
	⊕	PH1, PH2, PH3	⊗	TPX20, TPX25, TPX30	⊖	ROB1, 2, 3					
	⊗	TX10, TX15, TX20, TX25, TX30, TX40									
1/4" Hex bits:											
Length 89mm	⊖	3, 4	⊕	PH1, PH2	⊕	PZ1, PZ2					
	⊗	TX10, TX20, TX25									

Item ID: TT1448



3/8" DRIVE 19 Pieces mm

## SOCKET SET

- Regular 6 point single hexagon sockets
- Chrome vanadium satin finish sockets
- Designed and manufactured to DIN and ISO standards

72 Teeth ratchet, Universal Joint, 3" Wobble extension bar, 10" Spinner handle											
Coupler adaptor, 1/2" F x 3/8" M T-bar adaptor											
Regular 6 point sockets:											
mm:	8	9	10	11	12	13	14	15	16		
	17	18	19	22							

Item ID: TT3819

**NEW**



Get organised!

Tray Size

TT				
----	--	--	--	--

**SOCKET SET**

**3/8" DRIVE** **19 Pieces** **mm**

- Regular 12 point bi-hexagon sockets
- Chrome vanadium satin finish sockets
- Designed and manufactured to DIN and ISO standards

72 Teeth ratchet, Universal Joint, 3" Wobble extension bar, 10" Spinner handle										
Coupler adaptor, 1/2" F x 3/8" M T-bar adaptor										
Regular 12 point sockets:										
	mm:	8	9	10	11	12	13	14	15	16
		17	18	19	22					

Item ID: **TT381912**

**NEW**



Get organised!

Tray Size

TT				
----	--	--	--	--

**SOCKET SET**

**3/8" DRIVE** **16 Pieces** **mm**

- Deep 3/8" drive 12 point bi-hexagon sockets
- Chrome vanadium satin finish sockets
- Designed and manufactured to DIN3120/3124 and ISO2725

Deep 12 point sockets:										
	mm:	7	8	9	10	11	12	13	14	15
		16	17	18	19	20	21	22		

Item ID: **TT381612**



Get organised!

Tray Size

TT				
----	--	--	--	--

**SOCKET SET**

**3/8" DRIVE** **16 Pieces** **mm**

- Deep 3/8" drive 6 point single hexagon sockets
- Chrome vanadium satin finish sockets
- Designed and manufactured to DIN3120/3124 and ISO2725

Deep 6 point sockets:										
	mm:	7	8	9	10	11	12	13	14	15
		16	17	18	19	20	21	22		

Item ID: **TT3816**



Get organised!





Tray Size

TT				
----	--	--	--	--

**BIT SOCKET SET**

**1/4" DRIVE** **3/8" DRIVE** **30 Pieces**

- Chrome vanadium satin finish sockets
- Designed and manufactured to DIN and ISO standards

3" Extension bar, 3/8" F x 1/4" M adaptor										
3/8" Drive bit sockets:										
	TX:	10	15	20	25	27	30	40	45	50
	TPX:	10	15	20	25	27	30	40	45	50
	TX-E:	E10	E12	E14	E16	E18				
1/4" Drive bit sockets:										
	TX-E:	E4	E5	E6	E7	E8				

Item ID: **TTTX30**



Don't waste space with tools you don't need!  
 All tools are developed to fit the Get Organised system so you can fill your storage with a selection of tools to suit your exact needs



1/4" DRIVE 3/8" DRIVE 35 Pieces

## BIT SOCKET SET

- Includes all the most commonly used screwdriver, hex and TX bits
- Chrome vanadium satin finish sockets

3/8" F x 1/4" M adaptor, 1/4" F x 3/8" M adaptor										
3/8" Drive bit sockets:										
	mm:	3	4	5	5.5	6	7	8	10	12
	AF:	1/8	5/32	3/16	7/32	1/4	5/16	3/8		
1/4" Drive bit sockets:										
	TX:	10	15	20	25	27	30	40		
	mm:	4	4.5	7						
	PH:	0	1	2	3					
	PZ:	1	2	3						

Item ID: TTBS35



1/2" DRIVE 5 Pieces mm

## RATCHET & ACCESSORIES SET

- Socket accessory set
- Designed and manufactured to DIN and ISO standards

72 Teeth ratchet, 5" & 10" Extension bars
Universal joint, 3/8" F x 1/2" M T-bar adaptor

Item ID: TT1205



1/2" DRIVE 11 Pieces mm

## SOCKET SET

- 12 point bi-hexagon sockets
- Includes a 10" flex handle with ergonomic grip
- Chrome vanadium satin finish
- Designed and manufactured to DIN and ISO standards

10" Flex handle							
Deep 12 point sockets:							
	mm:	10	11	12	13	14	15
		16	17	18	19		

Item ID: TT1211



1/2" DRIVE 17 Pieces mm

## SOCKET SET

- 6 point single hexagon sockets
- Chrome vanadium satin finish sockets
- Designed and manufactured to DIN3120/3124 and ISO2725

Regular 6 point sockets:										
	mm:	10	11	12	13	14	15	16	17	18
		19	20	21	22	24	27	30	32	

Item ID: TT1217-6



1/2" DRIVE 17 Pieces mm

## SOCKET SET

- 12 point bi-hexagon sockets
- Chrome vanadium satin finish sockets
- Designed and manufactured to DIN3120/3124 and ISO2725

Regular 12 point sockets:										
	mm:	10	11	12	13	14	15	16	17	18
		19	20	21	22	24	27	30	32	

Item ID: TT1217





**SOCKET SET**

**1/2"** DRIVE **17** Pieces **mm**

- 6 point single hexagon sockets
- Chrome vanadium satin finish sockets
- Designed and manufactured to DIN and ISO standards

72 Teeth ratchet, 2 1/2" & 10" Extension bars										
Universal joint, 3/8"F x 1/2"M T-bar adaptor										
Regular 6 point sockets:										
	mm:	10	11	12	13	14	15	16	17	18
		19	22	24						

Item ID: **TT1218-6**



**SOCKET SET**

**1/2"** DRIVE **17** Pieces **mm**

- 12 point bi-hexagon sockets
- Chrome vanadium satin finish sockets
- Designed and manufactured to DIN and ISO standards

72 Teeth ratchet, 2 1/2" & 10" Extension bars										
Universal joint, 3/8"F x 1/2"M T-bar adaptor										
Regular 12 point sockets:										
	mm:	10	11	12	13	14	15	16	17	18
		19	22	24						

Item ID: **TT1218**



**SOCKET SET**

**1/2"** DRIVE **15** Pieces **AF**

- 12 point bi-hexagon sockets
- Chrome vanadium satin finish sockets
- Designed and manufactured to DIN3120/3124 and ISO2725

Regular 12 point sockets:										
	AF:	3/8	7/16	1/2	9/16	5/8	11/16	3/4	13/16	7/8
		15/16	1	1-1/16	1-1/8	1-3/16	1-1/4			

Item ID: **TT1215AF**



**HEX BIT SOCKET SET**

**1/2"** DRIVE **16** Pieces **mm**

- Chrome vanadium satin finish sockets
- Designed and manufactured to DIN7422

 Hex bit sockets mm:									
Length 55mm:	5	6	7	8	9	10	12	14	17
Length 100mm:	5	6	10	12	14	17			
Length 115mm:	8								

Item ID: **TTTHX16**



**1/2" DRIVE** 23 Pieces **mm**

## HEX BIT SOCKET SET

- Chrome vanadium satin finish bit holders included
- Grub screws to retain the bit in place, especially useful when working in difficult to reach places
- Designed and manufactured to DIN ISO 1173:2009-06

10mm Hex bit adaptor, 12mm Hex bit adaptor, 2mm Hex mini screwdriver									
Hex bit sockets mm:									
Length 40mm:	10mm Hex Drive:	5	6	7	8	9	10		
	12mm Hex Drive:	12	14	17	19				
Length 75mm:	10mm Hex Drive:	5	6	7	8	9	10		
	12mm Hex Drive:	12	14	17	19				

Item ID: **TTHEX23**



**1/2" DRIVE** 23 Pieces

## TX BIT SOCKET SET

- Chrome vanadium satin finish bit holders included
- Grub screws to retain the bit in place, especially useful when working in difficult to reach places
- Designed and manufactured to DIN ISO 1173:2009-06

10mm Hex bit adaptor, 12mm Hex bit adaptor, 2mm Hex mini screwdriver										
TX bit sockets:										
Length 40mm:	10mm Hex Drive:	20	25	27	30	40	45	50	55	
	12mm Hex Drive:	60	70							
Length 75mm:	10mm Hex Drive:	20	25	27	30	40	45	50	55	
	12mm Hex Drive:	60	70							

Item ID: **TTTX23**



**1/2" DRIVE** 18 Pieces

## TX BIT SOCKET SET

- Chrome vanadium satin finish sockets
- Designed and manufactured to DIN and ISO standards

TX bit sockets:										
Length 55mm:	20	25	27	30	40	45	50	55	60	
Length 110mm:	20	25	27	30	40	45	50	55	60	

Item ID: **TTTX18**



**1/2" DRIVE** 15 Pieces

## HEX & TX BIT SOCKET SET

- 100mm length for easier access in recesses
- Chrome vanadium satin finish sockets
- Designed and manufactured to DIN and ISO standards

TX bit sockets:										
Length 100mm:	20	25	27	30	40	45	50	55	60	
Hex bit sockets mm:										
Length 100mm:	5	6	7	8	10	12				

Item ID: **TTTXH15**



Get organised!

Tray Size



TT			
----	--	--	--

**RIBE & XZN BIT SOCKET SET**

- 100mm length for easier access in recesses
- Chrome vanadium satin finish sockets
- Designed and manufactured to DIN and ISO standards

**1/2"**  
DRIVE

**15**  
Pieces

 Ribe bit sockets:									
Length 100mm:	4	5	6	8	10	11	12	13	
 XZN bit sockets:									
Length 100mm:	5	6	8	10	12	14	16		

Item ID: **TTRS15**



Get organised!

Tray Size

TTX			
-----	--	--	--

**EXTENSION BARS SET**

- Includes a selection of long and wobble extension bars
- TengTools T-HD handle included for a more comfortable grip
- Designed and manufactured to DIN and ISO standards

**13**  
Pieces

1/4" Drive	6" & 12" Extension bars, Universal joint
3/8" Drive	3" Wobble extension bar, 20" Extension bar, Universal joint, 3/8" F x 1/4" M T-bar adaptor
1/2" Drive	3" Wobble extension bar, 20" Extension bar, Universal joint
T-handle grip, 2mm & 2.5mm Mini Hex Screwdrivers	

Item ID: **TTXEXT13**



Get organised!

Tray Size

TTX			
-----	--	--	--

**RATCHET & ACCESSORIES SET**

**3/4"**  
DRIVE

**4**  
Pieces

- Socket accessory set
- Quick release and twist reverse action for easier use
- Sliding T bar and extension bars also included
- Designed and manufactured to DIN and ISO standards

Quick release 72 teeth ratchet, 200mm & 400mm Extension bars
Sliding T-bar

Item ID: **TTX3404**



Get organised!

Tray Size

TTX			
-----	--	--	--

**RATCHET & ACCESSORIES SET**

**3/11"**  
DRIVE

**4**  
Pieces

- Socket accessory set
- With safety locking system to avoid tools being dropped
- Quick release and twist reverse action for easier use
- Sliding T bar and extension bars also included
- Designed and manufactured to DIN and ISO standards

Quick release 72 teeth ratchet, 200mm & 400mm Extension bars
Sliding T-bar

Item ID: **TTX3404S**

**NEW**



Get organised!

Tray Size

TTX			
-----	--	--	--

**EXTENDABLE RATCHET SET**

**3/4"**  
DRIVE

**2**  
Pieces

- Ratchet with extendable handle 545 to 860mm
- Extension bar 16"
- Designed and manufactured according to DIN3122D

72 teeth 3/4" Drive Extendable Ratchet
16" Extension bar

Item ID: **TTX3402E**



## SOCKET SET

3/4" DRIVE 14 Pieces mm

- Chrome vanadium
- Satin finish for a better grip when handling the sockets
- 6 point single hexagon sockets for a better grip
- Designed and manufactured to DIN3120/3124

Regular 6 point sockets:										
mm:	19	21	22	24	27	30	32	33	34	
	36	38	41	46	50					

Item ID: TTX3414



## SOCKET SET

3/4" DRIVE 14 Pieces AF

- Chrome vanadium
- Satin finish for a better grip when handling the sockets
- 12 point bi-hexagon sockets
- Designed and manufactured to DIN3120/3124

Regular 12 point sockets:										
AF:	7/8	15/16	1	1-1/16	1-1/8	1-3/16	1-1/4	1-5/16	1-3/8	
	1-7/16	1-1/2	1-5/8	1-3/4	1-7/8					

Item ID: TTX34AF



## SOCKET ADAPTOR SET

17 Pieces

- A selection of extension bars and adaptors in one handy set
- A full range of converters and adaptors from 1/4" to 1" drive
- Includes regular, magnetic and quick chuck holders for use with 1/4" hex bits
- Designed and manufactured to DIN standard

1/4" Drive:	1/4" Hex Coupler, Hex bit adaptor, 50mm Hex bit adaptor	
3/8" Drive:	1/4" Hex Coupler, Hex bit adaptor, 50mm Hex bit adaptor	
1/2" Drive:	50mm Hex bit adaptor	
Step Up Adaptors:	1/4"F x 3/8"M	3/8" x 1/2"M
	1/2"F x 3/4"F	3/4" - 1"F
Reducing Adaptors:	3/8"F x 1/4"M	1/2"F x 3/8"M
		3/4"F x 1/2"M
50mm & 70mm Magnetic bit holder, 50mm Chuck bit holder with quick release		

Item ID: TTADP17



## IMPACT SOCKET SET

1/4" DRIVE 3/8" DRIVE 24 Pieces mm

- Chrome molybdenum for use with power tools
- ANSI standard design for use with power tools with a ball bearing socket retainer

3/8"F x 1/4"M impact adaptor										
1/4" Drive Impact 6 point sockets:										
Reg mm:	6	7	8	10	13					
3/8" Drive Impact 6 point sockets:										
Reg mm:	8	10	11	12	13	14	16	17	19	
Deep mm:	8	10	11	12	13	14	16	17	19	

Item ID: TT9024





Get organised™  
Tray Size  
TT

**IMPACT SOCKET ACCESSORY SET**

**1/2"**  
DRIVE **11**  
Pieces

- A selection of extension bars and adaptors
- DIN standard design for use with a retaining pin and ring
- Chrome molybdenum for use with power tools

Impact Adaptors:	3/8"F x 1/2"M, 1/2"F x 3/4"M, 1/2"F x 3/8"M
Universal Joint, 3", 5" & 10" Extension bars	
Retaining rings & pins:	092194, 092244, P92320, P92325 x1

Item ID: **TT9207**



Get organised™  
Tray Size  
TT

**IMPACT SOCKET ACCESSORY SET**

**1/2"**  
DRIVE **11**  
Pieces

- A selection of extension bars and adaptors
- For use with ANSI sockets
- Chrome molybdenum for use with power tools

Impact Adaptors:	3/8"F x 1/2"M, 1/2"F x 3/4"M, 1/2"F x 3/8"M
Universal Joint, 3", 5" & 10" Extension bars	
Retaining rings & pins:	092194, 092244, P92320, P92325 x1

Item ID: **TT9207A**





Get organised™  
Tray Size  
TT

**IMPACT SOCKET SET**

**1/2"**  
DRIVE **16**  
Pieces **mm**

- ANSI standard design for use with power tools with a ball bearing socket retainer
- Chrome molybdenum for use with power tools

1/2" Drive Impact 6 point sockets: 								
 Reg mm:	13	15	16	17	18	19	22	24
 Deep mm:	13	15	16	17	18	19	22	24

Item ID: **TT9116N**

**NEW**





Get organised™  
Tray Size  
TT

**IMPACT SOCKET SET**

**1/2"**  
DRIVE **12**  
Pieces **mm**

- DIN standard design for use with a retaining pin and ring
- Chrome molybdenum for use with power tools
- O-rings & pins included
- Designed and manufactured to DIN3129

1/2" Drive Impact 6 point sockets: 							
 Reg mm:	19	21	22	24	27	30	32
 Deep mm:	19	21	22	24	27		

Item ID: **TT9212**





Get organised™  
Tray Size  
TT

**IMPACT SOCKET SET**

**1/2"**  
DRIVE **20**  
Pieces **mm**

- DIN standard design for use with a retaining pin and ring
- Chrome molybdenum for use with power tools
- Designed and manufactured to DIN3129

Retaining rings & pins: 092194, 092244, P92320, P92325 x1								
1/2" Drive Impact 6 point sockets: 								
 Reg mm:	13	15	16	17	18	19	22	24
 Deep mm:	13	15	16	17	18	19	22	24

Item ID: **TT9120DN**



## TX IMPACT BIT SOCKET SET

1/2" DRIVE 12 Pieces

- Chrome molybdenum for use with power tools
- DIN standard design for use with a retaining pin and ring

1/2" Drive Impact TX bit sockets:								
TX:	10	15	20	25	27	30	40	45
	50	55	60	70				

Item ID: TT9212TX



## HEX IMPACT BIT SOCKET SET

3/8" DRIVE 1/2" DRIVE 15 Pieces

- Chrome molybdenum for use with power tools
- DIN standard design for use with a retaining pin and ring
- Designed and manufactured to DIN3129

3/8" Drive Impact Hex bit sockets:								
mm:	4	5	6	7	8	10	12	
1/2" Drive Impact Hex bit sockets:								
mm:	5	6	8	10	12	14	17	19

Item ID: TT9015HX



## TORQUE STICK & WHEEL NUT SOCKET SET

1/2" DRIVE 8 Pieces mm

- For the correct tightening of wheel nut sockets on cars
- When the correct torque is reached the torque stick socket end stops turning while the drive end springs back with each stroke
- Reduces the risk of sheared wheel nut bolts or distorted rims and brake discs
- Chrome molybdenum wheel nut sockets with protective inserts to avoid damage to wheels

3/8" x 1/2" Torque step up adaptor				
1/2" Drive Torque sticks:				
Nm:	90	110	120	140
1/2" Drive wheel nut sockets:				
mm:	17	19	21	

Item ID: TTTS08



## IMPACT SOCKET SET

3/4" DRIVE 12 Pieces mm

- 7" impact extension bar included for reaching in to recessed wheels, etc
- DIN standard design for use with a retaining pin and ring (included)
- Chrome molybdenum for use with power tools
- Supplied in the unique TengTools double width TC tray

7" Extension bar						
Retaining rings & pins: O93538, P90437 x3						
3/4" Drive Impact 6 point sockets:						
Reg mm:	19 (3/4")	24	27 (1-1/16")	30 (1-3/16")	32	33
	34	36	38			

Item ID: TTD9416



Get organised!  
Tray Size  
TTX

**IMPACT SOCKET SET**

**3/4" DRIVE** **15 Pieces** **mm**

- DIN standard design for use with a retaining pin and ring
- Chrome molybdenum for use with power tools
- Supplied in the unique TengTools drawer width TTX tray

3/4" Drive Impact 6 point sockets: 				
Reg mm:	19 (3/4")	24	27 (1-1/16")	28
	30 (1-3/16")	32	34	36
Deep mm:	19 (3/4")	24	27 (1-1/16")	
	30 (1-3/16")	32	33	36

Item ID: **TTX9415**







Get organised!  
Tray Size  
TT

**IMPACT DRIVER SET**

**1/2" DRIVE** **20 Pieces**

- Includes a range of impact bits for removing stubborn fastenings

Reversible impact driver, coupler adaptor, 5/16" Hex x 3/8" M adaptor				
5/16" Hex bits: Length 36mm		6, 8, 10, 12		PH1, PH2, PH3, PH4
		4, 5, 6, 8		TX30, TX40, TX45, TX50, TX55

Item ID: **TTID20**







Get organised!  
Tray Size  
TT

**IMPACT DRIVER SET**

**1/4" DRIVE** **19 Pieces**

- Includes a range of impact bits, impact sockets and screw extractors
- A complete set for removing stubborn fastenings

1/4" Drive reversible impact driver, Impact Bit Adaptor, 1/4" Hex x 1/4" M adaptor						
1/4" Drive Impact 6 point sockets: 						
Reg mm:	8	10	13			
Screw Extractors:	1	2	3			
1/4" Hex Impact Bits: Length 50mm		3, 4, 5, 6				TX25, TX30, TX40
		PH2, PH3			PZ2, PZ3	

Item ID: **TTID19**

**Torque Tools**

**NEW**











Get organised!  
Tray Size  
TT

**TORQUE SCREWDRIVER SET**

**1/4" DRIVE** **38 Pieces**

- Includes a 1-5Nm 1/4" drive torque screwdriver
- Wide range of screwdriver bits and accessories
- Removable lid and dove tail joints

1-5Nm Torque screwdriver, 1/4" Mx1/4" Hex adaptor				
1/4" Hex bits: Length 25mm		3, 4.5, 5.5, 6.5		PH0, PH1, PH2, PH3
		2, 3, 4, 5, 6		PZ0, PZ1, PZ2, PZ3
		TX9, TX10, TX15, TX20, TX25, TX27, TX30, TX40		
		TPX10, TPX15, TPX20, TPX30, TPX40		
		PH2G		
		ROB1, 2, 3		

Item ID: **TTSD38**



Get organised!

Tray Size

TX

## TORQUE WRENCH SET

3/8" DRIVE

22 Pieces

- Ideal set for automotive technicians
- Equipped with an in-built angular gauge for easier after tightening
- Click type mechanism when the required torque is reached
- Additional ft/lb reference scale (range 15-75 ft/lb)
- Marked to show the correct place where pressure should be applied
- Twist locking facility to ensure the set torque is maintained
- Reversible 24 teeth ratchet (DIN3122) giving 15° increments
- Designed to torque right hand (clockwise) fasteners
- Accurate to +/- 4% conforms to ISO6789 for assured accuracy
- Individually tested and certified at the time of manufacture

3/8" Drive Torque wrench (20-110Nm, 15-75 ft/lb), 3" and 5" extension bars, adaptor for 10mm hex bits
10mm Hex Drive TX bits:
TX8, TX10, TX15, TX20, TX25, TX27, TX30, TX40
3/8" Drive Crow Foot Wrenches
10, 11, 12, 13, 14, 15, 16, 17, 18, 19 mm

Item ID: TTX3892



Get organised!

Tray Size

TX

## TORQUE WRENCH SET

1/2" DRIVE

1 Pieces

- Equipped with an in-built angular gauge for easier after tightening
- Additional ft/lb reference scale (range 30-150 ft/lb)
- Marked to show the correct place where pressure should be applied
- Twist locking facility to ensure the set torque is maintained
- Reversible 24 teeth ratchet (DIN3122) giving 15° increments
- Designed to torque right hand (clockwise) fasteners
- Accurate to +/- 4% conforms to ISO6789 for assured accuracy
- Individually tested and certified at the time of manufacture

1/2" Drive Torque wrench (40-210Nm, 30-150 ft/lb)
---

Item ID: TTX1292

**NEW**



Get organised!

Tray Size

TX

## P-SERIES TORQUE WRENCH SET

1/2" DRIVE

1 Pieces

- Click type mechanism to signal when the required torque is reached
- Simple to adjust and easy to read Nm scale
- Locking button to ensure the set torque is securely maintained
- Compact head for easier use in confined spaces
- Quick release 72 teeth ratchet mechanism with twist reverse (DIN3122)
- Designed to torque right hand (clockwise) fasteners
- Ergonomic bi-material grip for added comfort
- Marked to show the correct place where pressure should be applied
- Hanging facility which can be used together with a fall protection wire
- Accurate to +/- 4% and conforms to ISO6789 for assured accuracy
- Each torque wrench has it's own individual certification number

1/2" Drive P-SERIES Torque wrench (40-200Nm)
--

Item ID: TTXP1292



Get organised!

Tray Size

PS

## PRE SET TORQUE WRENCH SET

1/2" DRIVE

4 Pieces

- Click type mechanism to signal when the required torque is reached
- Fixed setting for consistent torque application
- Robust 24 teeth ratchet mechanism for 15° increments
- Rubber grip for added comfort particularly with repeated use
- Accurate to +/- 4% conforms to ISO6789 for assured accuracy
- Individually tested and certified at the time of manufacture
- Rack included for storing the tools on a wall or workbench panel

1/2" Drive Pre Set Torque Wrenches
90, 110, 120, 140 Nm

Item ID: TTPSTQ04





Get organised™	
Tray Size	
TTX	

**TORQUE MULTIPLIER SET**

1/2" DRIVE 3/4" DRIVE 2 Pieces

- Includes a 1/2" drive torque wrench giving a range of 40 to 210Nm
- The MP1400 torque multiplier can be used to multiply the torque at a ratio of 3:1 increasing the potential torque to 630Nm
- For use with 3/4" drive sockets

1/2" Drive Torque wrench (40-210Nm, 30-150 ft/lb)  
 1/2" F:3/4" M Torque multiplier (3 to 1 ratio) and maximum torque capacity 1,500Nm

Item ID: TTXMP12



Get organised™	
Tray Size	
TT	

**MIDGET COMBINATION SPANNER SET**

10 Pieces mm

- Short stubby spanners for use in confined spaces
- Off set at 15° for easier use on flat surfaces
- TengTools hip grip design for contact with the flat side of the fastening
- Chrome vanadium satin finish
- Designed and manufactured to DIN3113A

Midget Combination Spanners:  
 10, 11, 12, 13, 14, 15, 16, 17, 18, 19 mm

Item ID: TT6010M

**Spanners & Wrenches**



Get organised™	
Tray Size	
TT	

**ANTI SLIP COMBINATION SPANNER SET**

12 Pieces mm

- Off set at 15° for easier use on flat surfaces
- TengTools hip grip design for contact with the flat side of the fastening
- TengTools anti slip design on the open end to give a much better grip

Combination Spanners:  
 8, 9, 10, 11, 12, 13, 14, 15, 16, 17, 18, 19 mm



Item ID: TT8012



Get organised™	
Tray Size	
TT	

**COMBINATION SPANNER SET**

12 Pieces mm

- Off set at 15° for easier use on flat surfaces
- TengTools hip grip design for contact with the flat side of the fastening
- Chrome vanadium satin finish
- Designed and manufactured to DIN3113A

Combination Spanners:  
 8, 9, 10, 11, 12, 13, 14, 15, 16, 17, 18, 19 mm

Item ID: TT1236



Get organised™	
Tray Size	
TT	

**COMBINATION SPANNER SET**

8 Pieces AF

- Off set at 15° for easier use on flat surfaces
- TengTools hip grip design for contact with the flat side of the fastening
- Chrome vanadium satin finish
- Designed and manufactured to DIN3113A

Combination Spanners:  
 5/16", 3/8", 7/16", 1/2", 9/16", 5/8", 11/16", 3/4"

Item ID: TT3592



## COMBINATION SPANNER SET

7 Pieces mm

- Chrome vanadium, satin finish
- Off set at 15° for easier use on flat surfaces
- TengTools hip grip design for contact with the flat side of the fastening
- Designed and manufactured to DIN31 13A

Combination Spanners:

20, 21, 22, 24, 27, 30, 32 mm

Item ID: TTX2032



## COMBINATION SPANNER SET

7 Pieces AF

- Chrome vanadium, satin finish
- Off set at 15° for easier use on flat surfaces
- TengTools hip grip design for contact with the flat side of the fastening
- Designed and manufactured to DIN31 13A

Combination Spanners:

13/16", 7/8", 15/16", 1", 1-1/16", 1-1/8", 1-1/4"

Item ID: TTX2640



## LONG REACH COMBINATION SPANNER SET

12 Pieces mm

- Extra long for increased torque
- Off set at 15° for easier use on flat surfaces
- TengTools hip grip design for contact with the flat side of the fastening
- Designed and manufactured to DIN31 13A

Combination Spanners:

8, 9, 10, 11, 12, 13, 14, 15, 16, 17, 18, 19 mm

Item ID: TTXLMP12



## RATCHET SPANNER SET

8 Pieces mm

- 72 teeth ratchet spanners giving a 5° increment between clicks
- Reversible ratchet mechanism with a flip reverse lever
- TengTools hip grip design on the ring end
- Chrome vanadium satin finish
- Designed and manufactured to DIN ISO 1711-1 and DIN 3113A

Ratchet Spanners with flip reverse:

8, 10, 11, 12, 13, 14, 17, 19 mm

Item ID: TT6508R



## RATCHET SPANNER SET

11 Pieces mm

- 72 teeth ratchet spanners giving a 5° increment between clicks
- Reversible ratchet mechanism with hip grip & flip reverse lever
- Chrome vanadium satin finish
- Designed and manufactured to DIN ISO 1711-1 and DIN 3113A

Ratchet Spanners with flip reverse:

8, 10, 11, 12, 13, 14, 15, 16, 17, 18, 19 mm

Item ID: TT6511R



## RATCHET SPANNER SET

8 Pieces AF

- 72 teeth ratchet spanners giving a 5° increment between clicks
- Reversible ratchet mechanism with a flip reverse lever
- Chrome vanadium satin finish
- Designed and manufactured to DIN ISO 1711-1 and DIN 3113A

Ratchet Spanners with flip reverse:

5/16", 3/8", 7/16", 1/2", 9/16", 5/8", 11/16", 3/4"

Item ID: TT6508RAF



Get organised!

Tray Size

TT				
----	--	--	--	--

**FLEXIBLE HEAD RATCHET SPANNER SET**

8 Pieces **mm**

- 72 teeth ratchet spanners giving a 5° increment between clicks
- Flexible head for use at an angle or for reversing the direction of use when ratcheting
- Chrome vanadium satin finish
- Removable lid and dove tail joints

Flexible head Ratchet Spanners:

8, 10, 11, 12, 13, 14, 17, 19 mm
----------------------------------

Item ID: **TT6508RF**



Get organised!

Tray Size

TT				
----	--	--	--	--

**RATCHET SPANNER SET**

8 Pieces **mm**

- 72 teeth ratchet spanners giving a 5° increment between clicks
- Simply turn over to reverse the direction of use when ratcheting
- Chrome vanadium satin finish
- Designed and manufactured to DIN ISO 1711-1 & DIN 3113A

Ratchet Spanners:

8, 10, 11, 12, 13, 14, 17, 19 mm
----------------------------------

Item ID: **TT6508RS**



Get organised!

Tray Size

TT				
----	--	--	--	--

**RATCHET SPANNER SET**

11 Pieces **mm**

- 72 teeth ratchet spanners giving a 5° increment between clicks
- Hip grip on the ring end, turn spanner over to change direction
- Chrome vanadium satin finish
- Designed and manufactured to DIN ISO 1711-1 and DIN 3113A

Ratchet Spanners:

8, 10, 11, 12, 13, 14, 15, 16, 17, 18, 19 mm
--

Item ID: **TT6511RS**



Get organised!

Tray Size

TTX				
-----	--	--	--	--

**DOUBLE RING SPANNER SET**

11 Pieces **mm**

- Different size at each end to give 22 sizes in total
- Double curved heads offset at 75° for easier use on flat surfaces
- Chrome vanadium satin finish
- TengTools hip grip design for contact with the flat side of the fastening
- Designed and manufactured to DIN838

Double Ring Spanners:

6x7, 8x9, 10x11, 12x13, 14x15, 16x17, 18x19, 20x22, 21x23, 24x27, 30x32 mm
--

Item ID: **TTX6311**

**NEW**



Get organised!

Tray Size

TTX				
-----	--	--	--	--

**DOUBLE RING SPANNER SET**

7 Pieces **AF**

- Different size at each end to give 12 sizes in total
- Double curved heads offset at 75° for easier use on flat surfaces
- Chrome vanadium satin finish
- TengTools hip grip design for contact with the flat side of the fastening
- Designed and manufactured to DIN838

Double Ring Spanners:

1/4" x 5/16", 3/8" x 7/16", 7/16" x 1/2", 13/16" x 7/8", 15/16" x 1-1/16", 1" x 1-1/8", 1-1/8" x 1-1/4"
---

Item ID: **TTX6707**



Get organised!

Tray Size

TTX				
-----	--	--	--	--

**EXTRA LONG DOUBLE RING SPANNER SET**

6 Pieces **mm**

- Different size at each end to give 12 sizes in total
- Extra long, flat design for extra torque
- Chrome vanadium satin finish
- TengTools hip grip design for contact with the flat side of the fastening
- Designed and manufactured to DIN838

Extra long Double Ring Spanners:

8x10, 11x13, 12x14, 16x18, 17x19, 22x24 mm
--

Item ID: **TTXFLS06**



8 Pieces mm

## DOUBLE OPEN ENDED SPANNER SET

- Different size at each end to give 16 sizes in total
- Open at each end off set at 15° for easier use
- Chrome vanadium satin finish
- Designed and manufactured to DIN3110

Double Open Ended Spanners:

6x7, 8x9, 10x11, 12x13, 14x15, 16x17, 18x19, 20x22 mm

Item ID: TT6208

**NEW**



7 Pieces AF

## DOUBLE OPEN ENDED SPANNER SET

- Different size at each end to give 14 sizes in total
- Chrome vanadium satin finish
- TengTools hip grip design for contact with the flat side of the fastening
- Designed and manufactured to DIN 3110

Double Open Ended Spanners:

1/4" x 5/16", 3/8" x 7/16", 1/2" x 9/16", 5/8" x 3/4", 13/16" x 7/8", 15/16" x 1", 1-1/8" x 1-1/4"

Item ID: TTX6607



6 Pieces mm

## DOUBLE FLEX WRENCH SET

- Swivel end wrenches for fast pre-tightening and loosening
- Angle at 90° for added torque when applying the final tightening
- Extra torque for loosening stubborn fastenings
- Chrome vanadium satin finish
- Designed and manufactured to DIN standard

Double Flex Wrenches

8x9, 10x11, 12x13, 14x15, 16x17, 18x19 mm

Item ID: TT6506



6 Pieces mm

## RATCHETING OFFSET RING SPANNER SET

- Fibre reinforced reversible ratchet wrenches
- 18 teeth for extra strength and use in outdoor sites
- Double ended with 25° offset heads
- 12 point ring ends (6x8mm is 6 point)
- Chrome vanadium satin finish with FRP bodies

RORS Wrenches

6x8, 7x9, 10x13, 12x14, 17x19, 21x22 mm

Item ID: TTRORS



7 Pieces mm

## QUICK WRENCH SET

- Special design for loosening and tightening pipe and hose couplings
- Ideal for use in confined spaces
- Ring end has a clever design so that it opens up easily to access the nut on the coupling

Quick Wrenches

13, 17, 19, 22, 24, 27, 32 mm

Item ID: TTXQRS07



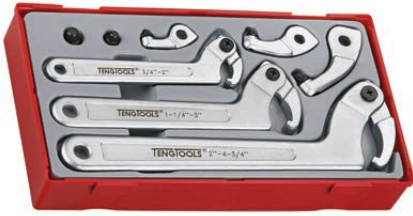

Get organised!  
Tray Size  
TT

8 Pieces

### HOOK AND PIN WRENCH SET

- Includes a range of handles, pin and hook adaptors
- Chrome vanadium satin finish
- To be used for nuts designed and manufactured to DIN1804 & 1816
- Wrench manufactured to DIN1810

Hook & Pin Wrenches	
Hook Handles:	3/4" to 2", 1-1/4" to 3", 2" to 4-3/4"
Pin Adaptors:	4, 5, 6 mm
Pins:	6, 8 mm

Item ID: TTHP08



Get organised!  
Tray Size  
TT

4 Pieces **TPR**

### ADJUSTABLE WRENCH SET

- Includes an 8" wide jaw adjustable wrench for added versatility
- Designed and manufactured to DIN3117 and ISO6787

Adjustable Wrenches	
6" (150 mm)	Capacity: 23.9 mm
8" (200 mm)	Capacity: 28.6 mm
10" (250 mm)	Capacity: 32.8 mm
8" (200 mm) Wide Jaw	Capacity: 38.6 mm

Item ID: TTADJ04

## Screwdrivers





Get organised!  
Tray Size  
TT

7 Pieces   

### SCREWDRIVER SET

- TT-MV PLUS steel alloy for greater strength and material flexibility
- Ergonomically designed bi-material handle for easy use with higher torque
- Hanging hole in the handle for use as a T handle or with a fall protection wire
- The handle is moulded around the blade to give a higher torque capacity

Screwdrivers:			
 mm:	3 x 75	5.5 x 75	6.5 x 100
 mm:	PH0 x 75	PH1 x 75	PH2 x 100
 mm:	PZ2 x 100		

Item ID: TT917N





Get organised!  
Tray Size  
TTD

14 Pieces   

### SCREWDRIVER SET

- TT-MV PLUS steel alloy for greater strength and material flexibility
- Ergonomically designed bi-material handle for easy use with higher torque
- Hanging hole in the handle for use as a T handle or with a fall protection wire
- The handle is moulded around the blade to give a higher torque capacity

Screwdrivers:				
 mm:	3 x 75	3.5 x 100	5.5 x 75	5.5 x 125
	6.5 x 38	6.5 x 100		
 mm:	PH0 x 75	PH1 x 75	PH2 x 38	PH2 x 100
 mm:	PZ0 x 75	PZ1 x 75	PZ2 x 38	PZ2 x 100

Item ID: TTD914N



## SCREWDRIVER SET



- TT-MV PLUS steel alloy for greater strength and material flexibility
- Ergonomically designed bi-material handle for easy use with higher torque
- Hanging hole in the handle for use as a T handle or with a fall protection wire
- The handle is moulded around the blade to give a higher torque capacity

Screwdrivers:				
⊖ mm:	6.5 x 38	3 x 100	6.5 x 100	10 x 200
	5.5 x 150	8 x 150		
⊕ mm:	PH2 x 38	PH3 x 150		

Item ID: TTX918N



## SCREWDRIVER SET



- TT-MV PLUS steel alloy for greater strength and material flexibility
- Ergonomically designed bi-material handle for easy use with higher torque
- Hanging hole in the handle for use as a T handle or with a fall protection wire
- The handle is moulded around the blade to give a higher torque capacity

Screwdrivers:			
⊕ mm:	TX6 x 75	TX9 x 75	
⊕ mm:	TPX10 x 100	TPX15 x 100	TPX20 x 100
	TPX25 x 100	TPX30 x 100	

Item ID: TT917TXN



## SCREWDRIVER SET



- TT-MV PLUS steel alloy for greater strength and material flexibility
- Ergonomically designed bi-material handle for easy use with higher torque
- Hanging hole in the handle for use as a T handle or with a fall protection wire
- The handle is moulded around the blade to give a higher torque capacity

Screwdrivers:				
⊕ mm:	TX6 x 75	TX7 x 75	TX8 x 75	TX9 x 75
	TX10 x 100	TX15 x 100	TX20 x 100	TX25 x 100
	TX27 x 100	TX30 x 100	TX40 x 100	TX45 x 125

Item ID: TTD912TXN



## SCREWDRIVER BLADE SET

- 22 screwdrivers in one set
- TT-MV PLUS steel alloy for greater strength and material flexibility
- Ergonomically designed bi-material handle for easy use with higher torque
- Hanging hole in the handle for use as a T handle or with a fall protection wire

Screwdriver Blade Handle With 1/4" Shank				
Screwdriver Blades:				
⊖ mm:	4 - 5.5			
⊕	PH1 - PH2			
⊕ ⊖ mm:	PH3 - 6.5			
	PZ1 - PZ2			
⊕ mm:	3 Ball - 3	4 Ball - 4	5 Ball - 5	6 Ball - 6
	TX:	10 - 15	20 - 25	30 - 40



Item ID: TTMD12D



5 Pieces  

**POWER THROUGH SCREWDRIVER SET**

- Chrome vanadium blades for greater strength and material flexibility
- Percussion cap and full length integral blade for use with a hammer to release stubborn screws
- Ergonomically designed bi-material handle for easy use with higher torque and faster speed
- The handle is moulded around the blade to ensure straightness and to allow larger blade wings which give a higher torque capacity

Screwdrivers:			
	mm:	6.5 x 100	8 x 150
	mm:	PH2 x 100	PH3 x 150



Item ID: TTXMDTN



16 Pieces   

**MINI PLIERS & SCREWDRIVER SET**

- Mini screwdrivers feature a rotating end piece for easier use when "transporting" the fastening
- Mini pliers feature high carbon steel construction and vinyl grip handles

Mini Screwdrivers:			
	mm:	2.0 x 40	2.4 x 40
	mm:	PH00 x 40	PH0 x 40
	mm:	TX6 x 40	TX7 x 40
		TX9 x 40	TX10 x 40
		TX11 x 40	TX15 x 40
Mini Pliers:			
4 1/2"			SIDE CUTTER
4 1/2"			END CUTTER
5"			LONG NOSE PLIER
5"			FLAT NOSE PLIER

Item ID: TTMI16

**NEW**



9 Pieces **mm**

**NUT DRIVER SET**

- 6 point socket ends for a perfect fit
- Chrome vanadium for greater strength and material flexibility
- Ergonomically designed bi-material handle for easy use with higher torque
- Hanging hole in the handle for use as a T handle or for use with a fall protection wire
- The handle is moulded around the blade which give a higher torque capacity

Nut Drivers:	
	5, 5.5, 6, 7, 8, 10, 11, 12, 13 mm

Item ID: TTXND













**Bits & Driver Sets**



1/4" DRIVE 49 Pieces

**SOCKET & BITS SET**

- Comprehensive selection of 25mm and 89mm 1/4" drive hex bits
- 1/4" drive regular sockets from 4 to 13mm
- Various drivers and accessories for use with bits and/or sockets

147mm Quick chuck driver, 1/4" drive ratchet head adaptor, 1/4"M x 1/4" Hex adaptor			
1/4" Drive Regular 6 point sockets:			
	mm:	4, 5, 5.5, 6, 7, 8, 9, 10, 11, 12, 13 mm	
1/4" Hex bits:			
Length 25mm:		3.5, 5.5, 8 mm	 PZ1, PZ2, PZ3
		PH1, PH2, PH3	 2, 3, 4, 5, 6, 8
		TX10, TX15, TX20, TX25, TX30, TX40	 TPX20, TPX25, TPX30
Length 89mm:		PH1, PH2	 4 mm  PZ2
		TX10, TX20, TX25	 4 mm

Item ID: TTMDQ49



1/4" DRIVE 76 Pieces

## SOCKET & BITS SET

- Quick chuck bits driver and adaptor for use with bits and/or sockets

217mm Quick chuck screwdriver handle, 1/4" M x 1/4" Hex adaptor	
1/4" Drive Regular 6 point sockets:	
mm:	4, 5, 5.5, 6, 7, 8, 9, 10, 11, 12, 13 mm
1/4" Hex bits:	
Length 25mm:	3.5, 4.0, 4.5, 5.5 (x2), 6.5, 8.0 mm  PH2G (x3)
	PH1 (x3), PH2 (x6), PH3  ROB1, 2, 3
	TX6, TX7, TX8, TX9, TX10, TX15, TX20 (x3), TX25 (x3), TX27, TX30, TX40
	TPX10, TPX15, TPX20 (x2), TPX25 (x2), TPX27, TPX30, TPX40
	PZ1 (x3), PZ2 (x6), PZ3  2, 3, 4, 5, 6, 8

Item ID: TTMDQ76



1/4" DRIVE 62 Pieces

## SOCKET & BITS SET

- Comprehensive selection of 25mm 1/4" drive hex bits included
- T handle bits driver with quick chuck adaptor on the long end and a magnetic bits holder on the short end

75mm Quick chuck T handle, 1/4" M x 1/4" Hex adaptor	
1/4" Drive Regular 6 point sockets:	
mm:	5, 5.5, 6, 7, 8, 9, 10, 11, 12, 13 mm
1/4" Drive TX-E bit sockets:	
TX-E:	E4, E5, E6, E7, E8
1/4" Hex bits:	
Length 25mm:	3.5, 5.5, 8 mm  PZ1, PZ2, PZ3
	PH1, PH2, PH3  2, 3, 4, 5, 6, 8
	TX6, TX7, TX8, TX9, TX10, TX15, TX20 (x3), TX25 (x3), TX27, TX30, TX40
	TPX10, TPX15, TPX20 (x2), TPX25 (x2), TPX27, TPX30, TPX40
	PH2G (x3)  ROB1, 2, 3

Item ID: TTTHQ62



1/4" DRIVE 84 Pieces

## SOCKET & BITS SET

- Reversible ratcheting bits driver, flexible extension and adaptor for use with bits and/or sockets

Ratcheting Quick chuck screwdriver handle, 1/4" M x 1/4" Hex adaptor, 150mm flexible extension bar	
1/4" Drive Regular 6 point sockets:	
mm:	4, 5, 5.5, 6, 7, 8, 9, 10, 11, 12, 13 mm
1/4" Hex bits:	
Length 25mm:	3.5, 4.0, 4.5, 5.5 (x2), 6.5, 8.0 mm  PH2G (x3)
	PH1 (x3), PH2 (x6), PH3  ROB1, 2, 3
	TX6, TX7, TX8, TX9, TX10, TX15, TX20 (x3), TX25 (x3), TX27, TX30, TX40
	TPX10, TPX15, TPX20 (x2), TPX25 (x2), TPX27, TPX30, TPX40
	PZ1 (x3), PZ2 (x6), PZ3  2, 3, 4, 5, 6, 8

Item ID: TTMDR84



1/4" DRIVE 38 Pieces

## SCREWDRIVER BIT SET

- An extensive range of 1/4" hex drive 25mm screwdriver bits
- 2 quick chuck bit driver handles included giving a choice of shaft lengths
- Removable lid and dove tail joints

147mm & 183mm Quick chuck screwdriver handles	
1/4" Hex bits:	
Length 25mm:	3.5, 5.5, 8 mm  PH1, PH2, PH3
	PZ1, PZ2, PZ3  ROB1, 2, 3
	TX10, TX15, TX20, TX25, TX30, TX40
	TPX20, TPX25, TPX30
	2, 3, 4, 5, 6, 8
Length 89mm:	PH1, PH2  3, 4 mm
	PZ1, PZ2  TX10, TX20, TX25

Item ID: TTMDQ38





Get organised!  
Tray Size  
TF

**SCREWDRIVER BIT SET**

74 Pieces

- An extensive range of 1/4" hex drive 25mm screwdriver bits
- Reversible, ratcheting bits driver, extension bars and adaptors included
- Removable lid and dove tail joints

Ratcheting bits handle, 6" flexible extension, 4" extension, 1/4" M:1/4" hex coupler adaptor, 1/4" F:1/4" hex coupler adaptor		
1/4" Hex bits:		
Length 25mm:	3.5, 4.0, 4.5, 5, 5.5 (x2), 6.5, 7, 8 mm	PH2G
	PH1 (x4), PH2 (x7), PH3	ROB1, 2, 3
	TX6, TX7, TX8, TX9, TX10, TX15, TX20 (x3), TX25 (x3), TX27, TX30, TX40	
	TPX10, TPX15, TPX20 (x2), TPX25 (x2), TPX27, TPX30, TPX40	
	PZ1 (x4), PZ2 (x7), PZ3	2, 3, 4, 5, 6, 8

Item ID: TTMD74



Get organised!  
Tray Size  
TTX

41 Pieces

**SOCKET & BITS SET**

- Long reach bit and socket drivers set
- Comprehensive selection of 25mm 1/4" drive hex bits
- 1/4" drive regular sockets from 4 to 13mm
- Ideal for use in difficult to reach places

555mm flexible spinner handle with 1/4" drive, 555mm flexible bits driver with 1/4" hex drive, 1/4" M:1/4" hex coupler adaptor	
1/4" Drive Regular 6 point sockets:	
mm:	4, 4.5, 5, 5.5, 6, 7, 8, 9, 10, 11, 12, 13 mm
1/4" Hex bits:	
Length 25mm:	4, 5.5, 8 mm
	3, 4, 5, 6, 8, 10
	PH0, PH1, PH2, PH3, PH4
	PZ0, PZ1, PZ2, PZ3
	TX8, TX10, TX15, TX20, TX25, TX27, TX30, TX40

Item ID: TTXMD41N



Get organised!  
Tray Size  
TF

**ANGLED RATCHETING BITS DRIVER SET**

64 Pieces

- Comprehensive selection of 25mm 1/4" drive hex bits
- Ratcheting bits driver with an adjustable handle angle to create a pistol type grip driver
- Removable lid and dove tail joints

Bits driver with adjustable angle setting, 1/4" M:1/4" hex coupler adaptor		
1/4" Drive Regular 6 point sockets:		
mm:	4, 5, 5.5, 6, 7, 8, 9, 10, 11, 12, 13 mm	
1/4" Hex bits:		
Length 25mm:	3.5, 4, 4.5, 5, 5.5 (x2), 6.5, 7, 8 mm	
	PH1 (x4), PH2 (x4), PH3 (x2)	ROB1, 2, 3
	TX6, TX7, TX8, TX9, TX10, TX15, TX20 (x3), TX25 (x3), TX27, TX30, TX40	
	PZ1, PZ2 (x3), PZ3 (x2)	2, 3, 4 (x3), 5, 6, 8

Item ID: TTMDRT64



Get organised!  
Tray Size  
TF

1/4" DRIVE 53 Pieces

**IMPACT BIT SET**

- Screwdriver, hex and TX bits in various lengths
- Metric and AF impact nut setters included
- New design impact bits and adaptors for higher torsion
- Suitable for use with impact power tools

60mm Impact magnetic bit holder, 60mm Impact quick chuck bit holder						
1/4" Drive Impact nut setters - Length 65mm						
	Size:	1/4"	8	10	13	
1/4" Hex Impact Bits:	PH1, PH2 (x2), PH3	PH2G (x2)	1, 2			
Length 30mm	PZ1, PZ2 (x2), PZ3	3, 4 (x2), 5, 6				
	TX10, TX15, TX20 (x2), TX25 (x2), TX27, TX30 (x2), TX40					
1/4" Hex Impact Bits:	TX10, TX15, TX20, TX25, TX27, TX30, TX40	1, 2, 3				
Length 50mm	3, 4, 5, 6	PH2G	PZ2			
1/4" Hex Impact Bits:	TX20, TX25, TX30	PH2 (x2)				
Length 89mm						

Item ID: TTBS53



## Hex & TX Keys



### T HANDLE HEX KEY SET

7 Pieces **mm**

- Ball point end on the long key end giving access at angles of up to 25°
- Regular hex end on the short arm gives the ability to apply higher torque
- Removable lid and dove tail joints

Ball Point T-Handle Hex Drivers:	
100 mm long:	2.5, 3, 4 mm
150 mm long:	5, 6, 7 mm
190 mm long:	8 mm

Item ID: TTHEx7



### T HANDLE HEX KEY SET

7 Pieces **mm**

- Regular hex end on the short and long arms gives the ability to apply higher torque
- Removable lid and dove tail joints

T-Handle Hex Drivers:	
100 mm long:	2.5, 3, 4 mm
150 mm long:	5, 6, 7 mm
190 mm long:	8 mm

Item ID: TTHEx7S



### T HANDLE HEX KEY SET

7 Pieces **AF**

- Ball point end on the long key end giving access at angles of up to 25°
- Regular hex end on the short and long arms gives the ability to apply higher torque
- Removable lid and dove tail joints

Ball Point T-Handle Hex Drivers:		
100 mm long:	3/32", 1/8", 5/32"	
150 mm long:	3/16", 7/32", 1/4"	
190 mm long:	5/16"	

Item ID: TTHEx7AF



### T HANDLE TX AND TPX KEY SET

7 Pieces

- TPX type on the long key end for tamper proof TX fastenings
- Regular TX end on the short arm giving the ability to apply higher torque
- Removable lid and dove tail joints

T-Handle TX Drivers:		
100 mm long:	TX/TPX10, TX/TPX15, TX/TPX20	
150 mm long:	TX/TPX25, TX/TPX27, TX/TPX30	
190 mm long:	TX/TPX40	

Item ID: TTTX7





Get organised!  
Tray Size  
TT

**HEX AND TX WRENCH SET**

28 Pieces mm AF

- Includes a range of ball point keys covering metric and AF hex key & TX keys
- Removable lid and dove tail joints

Ball Point Hex & TX Keys:	
	1.5, 2, 2.5, 3, 4, 5, 6, 7, 8, 10 mm
	5/64", 3/32", 1/8", 5/32", 3/16", 7/32", 1/4", 5/16", 3/8"
	TX8, TX9, TX10, TX15, TX20, TX25, TX27, TX30, TX40

Item ID: TTHT28

**Pliers**



Get organised!  
Tray Size  
TT

**PLIER SET**

- Vinyl grip for easier use in pockets or tool pouches
- All the most commonly used pliers in one set

Pliers:	
SIDE CUTTER	6" / 155 mm
COMBINATION	7" / 180 mm
LONG NOSE	8" / 200 mm
WATER PUMP	10" / 250 mm

Item ID: TT440

4 Pieces



Get organised!  
Tray Size  
TTD

**PLIER SET**

- Vinyl grip for easier use in pockets or tool pouches
- All the most commonly used pliers in one set
- Supplied in the unique TengTools double width TC tray

Pliers:		Pliers:	
HEAVY DUTY SIDE CUTTER	6" / 160 mm	LONG NOSE	6" / 160 mm
	8" / 200 mm		8" / 200 mm
HIGH LEVERAGE COMBINATION	6" / 160 mm	WATER PUMP	7" / 180 mm
	8" / 200 mm		10" / 250 mm

Item ID: TTD441

8 Pieces



Get organised!  
Tray Size  
TT

**PLIER SET**

- TPR grip for a more secure and comfortable grip
- All the most commonly used pliers in one set

Pliers:	
SIDE CUTTER	6" / 155 mm
COMBINATION	7" / 180 mm
LONG NOSE	8" / 200 mm
WATER PUMP	10" / 250 mm

Item ID: TT440-T

4 Pieces TPR



## PLIER SET

- TPR grip for a more secure and comfortable grip
- All the most commonly used pliers in one set
- Supplied in the unique TengTools double width TC tray

8 Pieces **TPR**

Pliers:	
HEAVY DUTY SIDE CUTTER	6" / 160 mm
	8" / 200 mm
HIGH LEVERAGE COMBINATION	6" / 160 mm
	8" / 200 mm

Pliers:	
LONG NOSE	6" / 160 mm
	8" / 200 mm
WATER PUMP	7" / 180 mm
	10" / 250 mm

Item ID: TTD441-T



## PLIER & WRENCH SET

- 2 tools for gripping even the most stubborn nuts and bolts
- Supplied in the unique TengTools drawer width TTX tray

2 Pieces

Pliers:	
QUICK ACTION WATER PUMP	10" / 250 mm
Wrenches	
ALIGATOR ADJUSTABLE	8" / 200 mm

Item ID: TTXMBO2



## CIRCLIP PLIER SET

- For use with inner and outer type circlips or snap rings
- 1.25mm tip and 10 to 25mm capacity
- Chrome vanadium construction
- Return spring for easier use
- Vinyl grip for easier use in pockets or tool pouches
- DIN5254

4 Pieces

5" / 130 mm Circlip Pliers:		Capacity
STRAIGHT	INNER	10 - 25 mm
	OUTER	10 - 25 mm
BENT	INNER	10 - 25 mm
	OUTER	10 - 25 mm

Item ID: TT474-5



## CIRCLIP PLIER SET

- For use with inner and outer type circlips or snap rings
- 1.8mm tip and 19 to 60mm capacity
- Chrome vanadium construction
- Return spring for easier use
- Vinyl grip for easier use in pockets or tool pouches
- DIN5254

4 Pieces

7" / 175 mm Circlip Pliers:		Capacity
STRAIGHT	INNER	19 - 60 mm
	OUTER	19 - 60 mm
BENT	INNER	19 - 60 mm
	OUTER	19 - 60 mm

Item ID: TT474-7





**CIRCLIP PLIER SET**

- Invisible return spring for easier operation
- For use with inner and outer type circlips or snap rings
- 1.8mm bearing steel tips for heavy duty applications
- Non slip tip angle enabling the ring to stock securely to the tip when compressing or expanding the circlip
- 19 to 60mm capacity
- Chrome vanadium construction
- Return spring for easier use
- Vinyl grip for easier use in pockets or tool pouches
- DIN5254

7" Circlip Pliers:		Capacity
STRAIGHT	INNER	19 - 60 mm
	OUTER	19 - 60 mm
BENT	INNER	19 - 60 mm
	OUTER	19 - 60 mm



Item ID: **TT474-7E**



**CIRCLIP PLIER SET**

- For use with inner and outer type circlips or snap rings
- 2.25mm tip and 40 to 100mm capacity
- Chrome vanadium construction
- Return spring for easier use
- Vinyl grip for easier use in pockets or tool pouches
- DIN5254

9" / 225 mm Circlip Pliers:		Capacity
STRAIGHT	INNER	40 - 100 mm
	OUTER	40 - 100 mm
BENT	INNER	40 - 100 mm
	OUTER	40 - 100 mm

Item ID: **TTX474-9**



**POWER GRIP PLIER SET**

- All the most commonly used power grip pliers in one set
- Self locking with release lever
- With locking nut on adjustment knob for pre-setting, ideal for repeated use
- Wire cutter and crimper function
- Chrome molybdenum

Power Grip Pliers:	
STANDARD ROUND JAW	4" / 100 mm
	7" / 180 mm
	10" / 250 mm
LONG NOSE	4" / 100 mm
	6" / 155 mm

Item ID: **TTVG05**



**POWER GRIP PLIER SET**

- The most commonly used power grip pliers in one set
- Self locking with release lever
- With locking nut on adjustment knob for pre-setting, ideal for repeated use
- Wire cutter and crimper function
- Chrome molybdenum

Power Grip Pliers:	
STANDARD ROUND JAW	4" / 100 mm
LONG NOSE	4" / 100 mm
	6" / 155 mm

Item ID: **TTZVG03**



## WELDING PLIER SET

4 Pieces

- Includes all the most commonly used welding pliers in one set
- Supplied in the unique TengTools PS tray
- Designed to fit exactly in TengTools tool box drawers
- Can be used as a set on it's own or as part of the TengTools "Get Organised" system

Power Grip Pliers:	
LONG NOSE	6" / 155 mm
SHEET METAL GRIP	8" / 230 mm
WELDING GRIP	9" / 230 mm
C CLAMP PLIER	11" / 280 mm

Item ID: TTPSPG

## Insulated Tools



## INSULATED SCREWDRIVER SET

- Approved for live working up to 1,000 volts
- Integrated protective insulation with two colours to clearly indicate if there is any damage
- Designed and manufactured to DIN5264, DIN ISO 8764-1 and IEC60900 (EN60900)

1000V Insulated Screwdrivers:		
mm:	4 x 100	5.5 x 125
mm:	PH1 x 80	PH2 x 100
mm:	PZ1 x 80	PZ2 x 100

Item ID: TTV706N



## INSULATED SCREWDRIVER SET

- Approved for live working up to 1,000 volts
- Integrated protective insulation with two colours to clearly indicate if there is any damage
- Designed and manufactured to DIN5264, DIN ISO 8764-1 and IEC60900 (EN60900)

1000V Insulated Screwdrivers:			
mm:	2.5 x 75	4 x 100	5.5 x 125
mm:	PH0 x 60	PH1 x 80	PH2 x 100
mm:	PZ2 x 100		

Item ID: TTV907N



## INSULATED SCREWDRIVER SET

- Approved for live working up to 1,000 volts
- Integrated protective insulation with two colours to clearly indicate if there is any damage
- Designed and manufactured to DIN5264, DIN ISO 8764-1 and IEC60900 (EN60900)

1000V Insulated Screwdrivers:				
mm:	2.5 x 75	3 x 100	4 x 100	5.5 x 125
mm:	PH0 x 60	PH1 x 80	PH2 x 100	
mm:	PZ0 x 60	PZ1 x 80	PZ2 x 100	





Item ID: TTDV910N

**NEW**



**INSULATED SCREWDRIVER SET**

- Interchangeable blades for a wide range of tips in one set
- Approved for live working up to 1,000 volts
- Integrated protective insulation with two colours to clearly indicate if there is any damage
- Designed and manufactured to DIN5264, DIN ISO 8764-1 and IEC60900 (EN60900)

Insulated handles: 22x100mm, 37x122mm			
1000V Insulated Screwdriver blades:			
	Reg mm:	3 x 70	
	Slim mm:	4 x 100	5.5 x 80    6.5 x 100
	mm:	PH1 x 80	PH2 x 100
	mm:	PZ1 x 80	PZ2 x 100

Item ID: **TTV710N**



**INSULATED PLIER SET**

- Approved for live working up to 1,000 volts
- Integrated protective insulation with two colours to clearly indicate if there is any damage
- TPR grip for a more secure and comfortable grip
- Designed and manufactured to DIN5745, DIN5746, DIN5749 and IEC60900 (EN60900)

1000V Insulated Pliers:	
SIDE CUTTER	6" / 150 mm
LONG NOSE	8" / 200 mm
COMBINATION PLIERS	7" / 175 mm
WIRE STRIPPING PLIERS	6" / 155 mm

Item ID: **TTV440**

**Cutting Tools**



5 Pieces

**CUTTING TOOL SET**

- Includes high leverage tin snips for straight, left and right cutting
- Utility knife with retractable blade and ergonomic grip
- High carbon stainless steel blade industrial scissors
- Heavy duty cable cutters with compound leverage for easier cutting

Cutting Tools:
Tin snips (straight/left & straight/right), utility knife, scissors, heavy duty cable cutters

Item ID: **TTDCT05**



40 Pieces

**UTILITY AND CRAFT KNIFE SET**

- Includes a selection of different knives to suit all types of use
- Spare blades included for each type of knife

Knives:
Utility knife with auto load function, folding universal knife, folding mini utility knife, hobby knife with 9mm blade, hobby knife with 18mm blade
Spare blades:
5 x Regular knife blades, 10 x Mini knife blades, 10 x 9mm Snap off blades, 10 x 18mm Snap off blades

Item ID: **TTK40**



28 Pieces

## FULLY GROUND DRILL BIT SET

- Standard drill bits for use with steel and cast iron, etc.
- Spiral angle of 28° for clean cutting
- Split point angle of 118° for better positioning
- Shank the same diameter as the tip
- Designed and manufactured to DIN338

### Fully Ground Drill Bits:

1.0 (x3), 1.5 (x3), 2.0 (x2), 2.5 (x2), 3.0, 3.5, 4.0, 4.5, 5.0, 5.5, 6.0, 6.5, 7.0, 7.5, 8.0, 8.5, 9.0, 10.0, 10.5, 11.0, 12.0, 13.0

Item ID: TTDB28



17 Pieces

## TAP AND DIE SET

- Suitable for repairing damaged threads from M3 to M12
- Tap and die holders included
- A thread gauge is included to help identify the pitch of the thread

### Metric dies:

3x0.5 mm, 4x0.7 mm, 5x0.8 mm, 6x1.0 mm, 8x1.25 mm, 10x1.5 mm, 12x1.75 mm

### Metric taps:

3mm, 4mm, 5mm, 6mm, 8mm, 10mm, 12mm

### Accessories:

Tap handle (capacity 3 to 12mm), die handle with adjustment screw (capacity 3 to 12mm), screw pitch gauge

Item ID: TTDD17



34 Pieces

## TAP AND DIE SET

- Designed for the repair of damaged threads covering M3 to M12
- Includes taps and dies with interchangeable chucks
- Screw extractors also included to give a complete set for repairing threads
- Various accessories including drill bits, a screw pitch gauge and mini palm ratchet

### Metric dies:

3x0.5 mm, 4x0.7 mm, 5x0.8 mm, 6x1.0 mm, 8x1.25 mm, 10x1.5 mm, 12x1.75 mm

### Metric taps:

3mm, 4mm, 5mm, 6mm, 8mm, 10mm, 12mm

### Fully ground drill bits:

2.5, 3.3, 4.2, 5.0, 6.8, 8.5, 10.5 mm

### Screw extractors:

1/8", 3/16", 15/64", 5/16", 3/8"

### Accessories:

Screw pitch gauge, mini screwdriver hex (2.5x40mm), 1/4" extension bar, 3/8"F:1/4"M adaptor, 1/4" mini palm ratchet, 1/4" interchangeable die chuck, 1/4" tap chuck (x2 - M3-M8, M5-M12)

Item ID: TTDTD34



12 Pieces

## NEEDLE FILE SET

- All the most commonly used types of needle file in one handy set
- Removable lid and dove tail joints

### Needle Files:

Hand, half round, three square, square, round, flat point, knife type, barrette, crossing, oval, feather edge, round edge flat

Item ID: TTNF12





Get organised™  
Tray Size  
**TX**

**HAND FILE SET**

5 Pieces

- 10" high carbon steel hand files
- Bi-material handle for a more comfortable grip
- 2nd cut to create a diamond pattern cutting surface for smoother filing
- Cut on both edges of the flat files for filing grooves, etc

10" Files:

Flat, Hand, Half Round, Round, Three square
---

Item ID: TTXF05

**Measuring Tools**



Get organised™  
Tray Size  
**TT**

**MEASURING TOOL SET**

4 Pieces

- Ideal for engineers and technicians
- Includes a 4 function vernier caliper, steel rule, scriber and base square

Measuring Tools:

Vernier caliper	mm/inch	150 mm/6"
Steel rule	mm	150
Base square	mm	100 x 70
Scriber TC tipped	mm	150

Item ID: TTBM



Get organised™  
Tray Size  
**TTD**

**MEASURING TOOL SET**

4 Pieces

- Ideal for mechanics and technicians
- Includes a 4 function digital caliper, multimeter, thread gauge and feeler gauge sets

Measuring Tools:

Digital caliper	mm/inch	150mm/6"
Thread gauge set	mm/UNC	0.25-6.0mm, 4-42 UNC
Feeler gauge set	mm	100mm blades 0.05 to 1.0mm
Multimeter	AC, DC, voltage, current, resistance, temperature, CATI 600	

Item ID: TTDCM

**Auto Tools**



Get organised™  
Tray Size  
**TT**

**HOOK AND PICK SET**

4 Pieces

- 4 piece hook and pick set
- Includes hooks, awls and picks for detail work and scribing
- Ideal for cleaning components and retrieving lost items in hard to reach places

Hooks & Picks:

Straight Awl, 35° Hook tool, 90° Hook Tool, 125° Hook Tool
--

Item ID: TTMDP



Get organised!

Tray Size

TT			
----	--	--	--

## SCRAPER SET

4 Pieces

- Includes a gasket scraper, an awl and two hook tools
- Ideal for cleaning, scraping and removing unwanted residue

Scrapers:	
Gasket scraper	22mm wide blade, total length 245mm
Hooks & awl	Curved hook, 90° hook and awl

Item ID: TTSR04



Get organised!

Tray Size

TT			
----	--	--	--

## HOSE CLAMP SET

3 Pieces

- Range of sizes giving a capacity of 6 to 57mm (1/4" to 2 1/4")
- Specially designed jaws prevent internal hoses from damage when clamping
- Lightweight and easy to use
- Non conductive

Hose clamps:	
For hoses: 1/4"-3/4", 1/4"-1-1/4", 3/4"-2-1/4"	

Item ID: TTHC03



Get organised!

Tray Size

TT			
----	--	--	--

## AUTOMOTIVE SOCKET SET

3/8" DRIVE

1/2" DRIVE

7 Pieces

- All the most commonly used specialist automotive sockets in one handy set
- Includes sockets for removing and installing injectors, oil sender and vacuum switches as well as various oxygen sensors

3/8" Drive Sockets:		
22 mm	Length: 90 mm	Oxygen sensor socket for Mitsubishi, Nissan, Opel, Vauxhall & VW
7/8"	Length: 80 mm	Vacuum switch socket
1-11/16"	Length: 74 mm	Oil sender socket
7/8"	Length: 30 mm	Offset oxygen sensor socket
1/2" Drive Sockets:		
29 mm	Length: 90 mm	Oxygen sensor socket for GM
27 mm	Length: 85 mm	Injector socket for M24
7/8"	Length: 50 mm	Heated oxygen sensor socket

Item ID: TTSS07



Get organised!

Tray Size

TT			
----	--	--	--

## OIL SERVICE SET

3/8" DRIVE

16 Pieces

- All the tools normally required for an oil service included in one handy set
- Includes an oil filter wrench, drain plug set, spark plug sockets, metric feeler gauge set and a 3 in 1 inspection tool with magnetic pick up

3/8" Drive Accessories:	
3" & 10" wobble extensions, 1/2" F x 3/8" Male T-bar adaptor	
3/8" Drive Sockets:	
21mm regular 6 point socket, 16 & 21mm spark plug sockets	
Drain Plug Set:	
Bar, 5/16" hex x 3/8" hex, 11mm square x 12mm hex, 17mm hex x 1/2" hex, 8mm square x 3/8" square, 13mm square x 14mm hex, 8mm hex x 10mm hex	
Service Tools:	
Strap type oil filter wrench, 3 in 1 telescopic inspection tool, 20 piece feeler gauge set (0.05 mm - 1.0 mm)	

Item ID: TTOS16



Get organised!
Tray Size
TTA

**SPARK PLUG SOCKET SET**

**3/8" DRIVE** **5 Pieces** **mm**

- Spark plug socket set
- 3/8" drive extra long swivelling spark plug sockets for use in hard to reach places
- T bar with the TengTools T-HD handle for more comfortable use

2 Piece T-bar handle
3/8" Drive extra long swivelling spark plug sockets:
 mm: 14 16 21

Item ID: **TTXB05**



Get organised!
Tray Size
TTX

**LONG T-BAR SOCKET SET**

**3/8" DRIVE** **9 Pieces** **mm**

- Extra long socket set
- 3/8" drive extra long sockets for use in hard to reach places
- T bar with the TengTools T-HD handle for more comfortable use

2 Piece T-bar handle
3/8" Drive extra long sockets:
 mm: 8 10 12 13 14 17 19

Item ID: **TTXTB09**



Get organised!
Tray Size
TT

**FLARING TOOL SET**

**10 Pieces**

- Suitable for copper, brass and thin walled aluminium tubing
- 45° tube press flare pipes from 3/16" to 5/8" (4 to 14mm) diameter
- Heavy duty pipe cutter included for cutting pipes up to 32mm (1-1/4") diameter

2 piece double flaring tool set	
Pipe Cutter:	3-32 mm (1/8"-1-1/4")
Adaptors:	4, 4.75 (3/16"), 6 (1/4"), 8 (5/16"), 10, 12, 14 mm

Item ID: **TTTF10**



Get organised!
Tray Size
PS

**BODYWORK HAMMER SET**

**5 Pieces**

- A selection of hammers for use in the automotive body shop or metal working area

Hammers:
Dead blow hammers with 35 and 55mm diameter heads, crown face hammers with straight pein, pick heads and square milled face

Item ID: **TTPSAD**

**Service Tools**



Get organised!
Tray Size
TT

**UNIVERSAL PULLER SET**

**4 Pieces**

- Three legged combination puller
- Supplied with an extra yoke for switching to two legged pulling
- Reversible legs for internal or external grip

Pullers:
Combination twin/triple 6" leg puller with 4" capacity

Item ID: **TT804**



Get organised!

Tray Size

TT				
----	--	--	--	--

1/2" DRIVE 11 Pieces

## EXTRACTOR SET

- Includes screw extractors, stud extractors and nut splitters
- Ideal for use with broken nuts, bolts, studs and screws

1/2" Drive Stud Extractors:
6, 8, 10, 12 mm
Screw Extractors:
7/64", 9/64", 5/32", 1/4", 19/64"
Nut Splitters:
5 to 20mm, 14 to 27mm

Item ID: TTSN11



Get organised!

Tray Size

TT				
----	--	--	--	--

3/8" DRIVE 1/2" DRIVE 18 Pieces

## STUD EXTRACTOR SET

- Includes all the most commonly used sizes from 6mm (5/16") to 25mm (1")
- Designed for removing rounded or damaged bolt heads or nuts
- 4mm parallel pin punch included for clearing debris from the extractors
- Chrome vanadium satin finish
- Designed and manufactured to DIN3120/3124 and ISO2725

3/8" Drive Stud Extractors:
6 (5/16"), 8, 10 (3/8"), 11 (7/16"), 12, 13 (1/2"), 14 (9/16"), 16 (5/8"), 17 mm
1/2" Drive Stud Extractors:
19, 21, 22, 24, 25 mm
3/4", 13/16", 7/8", 15/16", 1"
Parallel Pin Punch:
4mm (150mm length)

Item ID: TTBE18



Get organised!

Tray Size

TTX				
-----	--	--	--	--

3 Pieces

## PRY BAR SET

- Includes roll/heel bars in three sizes to suit different applications

Roll heel bars:
12", 16", 20"

Item ID: TTXPB3



Get organised!

Tray Size

TTX				
-----	--	--	--	--

3 Pieces

## PRY BAR SET

- Includes pry bars in three sizes and shapes to suit different applications

Roll heel bars:
12", 18", 22"

Item ID: TTXPB3A



Get organised!

Tray Size

TT				
----	--	--	--	--

121 Pieces

## CRIMPING PLIER SET

- Multi function 9" crimping plier and wire stripper
- Use on insulated, non insulated terminals and connectors
- Wire stripping capacity from 0.75 to 6mm
- Cutting function for M2 to M5 bolt sizes
- Includes a range of insulated, non insulated terminals and connectors

Crimping Tool:
Multi function CP50 crimping tool
Terminals/connectors:
Red #6 ring terminals x 20
Blue #8 spade terminals x 20
Red butt connectors x 20
Blue butt connectors x 20
Blue 6.3x0.8mm female connectors x 20
Blue 6.3x0.8mm male connectors x 20

Item ID: TTCP121





Get organised!

Tray Size

TT			
----	--	--	--

4 Pieces

**CRIMPING PLIER SET**

- Interchangeable ratchet crimping tool
- Automatic locking mechanism to ensure a consistent and correct crimping action
- Cutting function for M2 to M5 bolt sizes
- Includes a range of interchangeable heads
- Use on insulated, non insulated terminals and connectors

<b>Crimping Tool:</b>
Changeable ratchet crimping tool for insulated terminals 22-10 AWG
<b>Terminals/connectors:</b>
Die for non-insulated open barrel connector, commercial type 22-12 AWG (0.324 square mm - 3.31 square mm)
Die for non-insulated terminals 22-8 AWG (0.3 square mm - 8 square mm)
<b>Other Tools:</b>
Hex key wrench 2.5mm

Item ID: **TTCP04**



Get organised!

Tray Size

TT			
----	--	--	--

6 Pieces

**PIPE CUTTER SET**

- For cutting plastic, copper and brass pipes from 3 to 22mm diameter
- Deburring tool included for tidying up any sharp edges

<b>Pipe Cutters:</b>
Capacity: 10, 12, 15, 22 mm
Adjustable pipe cutter capacity: 3-22 mm
<b>Accessories:</b>
Deburring tool

Item ID: **TTTC06**



Get organised!

Tray Size

TT			
----	--	--	--

81 Pieces

**RIVET GUN SET**

- Aluminium alloy, forged steel upper handle with heat treated jaws for durability
- Suitable for aluminium and steel rivets from 2.4 to 4.8mm and stainless steel rivets up to 4.0mm
- Includes 80 assorted rivets in individual storage compartments

<b>Hand rivetter:</b>
4 nozzles to suit aluminium/steel blind rivets (2.4, 3.2, 4.0, 4.8 mm)
<b>Aluminium rivets:</b>
2.4mm (3/32") x 20 black
3.2mm (1/8") x 20 black
4.0mm (5/32") x 20 black
4.8mm (3/16") x 20 black
<b>Accessories:</b>
Nozzle wrench

Item ID: **TTHR81**



Get organised!

Tray Size

TT			
----	--	--	--

81 Pieces

**NUTSERT GUN SET**

- Aluminium alloy, forged steel upper handle with heat treated jaws for durability
- Quick change, lockable threaded mandrels
- Mandrels for M3, M4, M5 and M6 included
- Includes 75 assorted nutserts in individual storage compartments

<b>Nutsert Tool:</b>
4 quick change mandrels (M3 x 0.5, M4 x 0.7, M5 x 0.8, M6 x 1.0)
<b>Aluminium rivets:</b>
M3 x 20 pieces
M4 x 20 pieces
M5 x 20 pieces
M6 x 15 pieces
<b>Accessories:</b>
Nose piece wrench

Item ID: **TTNR81**



## INSPECTION SET

- Ideal set for finding and retrieving lost nuts and bolts, etc.
- An extending mirror and magnifier with adjustable heads
- The extending magnetic pick up tool helps retrieve items up to 4,500g
- Mirror & magnifying glass extend to 96cm and the magnet extends to 76cm

Inspection Tools:
Telescopic magnifying glass
Telescopic inspection mirror
Telescopic magnetic pick up tool

Item ID: **TTM03**

3 Pieces



## PUNCH AND CHISEL SET

- Flat cold chisel made from chrome molybdenum
- Pin punches made from chrome vanadium

Punches:		
Centre	Length: 150 mm	5 mm
Parallel	Length: 150 mm	3, 4, 5, 6, 7, 8 mm
Flat cold chisels:		
150 mm		Width: 19 mm
200 mm		Width: 25 mm

Item ID: **TTPC09**

9 Pieces



## INSPECTION SET

- Ideal set for finding and retrieving lost nuts and bolts, etc.
- Includes telescopic magnetic pick up, magnifying glass, inspection mirror, a flexible claw pick up and even an LED torch

Inspection Tools:	
LED flashlight	
Flexible magnetic pick up	length 310mm
Telescopic magnetic pick up	length 160-480mm
38mm magnifying glass 1:3	with magnetic adaptor
38mm inspection mirror	with magnetic adaptor
230mm flexible claw pick up tool	
Batteries AAA (2 pieces)	

Item ID: **TTM08**

8 Pieces

**Air Tools****AIR IMPACT WRENCH SET**

- Compact and lightweight 1/2" drive impact wrench
- For use in confined spaces
- Supplied with stubby 1/2" drive impact sockets
- Supplied in the unique TengTools tray to be used within the Get Organised System

IMPACT SOCKETS - 1/2" STUBBY:		
10, 12, 13, 14, 15, 16, 17, 18, 19, 21, 22, 24 mm		
COMPACT IMPACT WRENCH SPECIFICATION:		
Square drive		1/2"
Bolt capacity	mm	M16
Free speed	rpm	8,000
Max torque (3 steps)	Nm	285/380/680
Max torque (3 steps)	ft-lb	210/280/501
Max reverse torque	Nm	770
Max reverse torque	ft-lb	568
Hammer mechanism	type	Jumbo hammer
Sound level *	dB	102
Vibration **	m/s <sup>2</sup>	7.5
Minimum hose size	inch	3/8"
Air inlet	inch	1/4"
Air consumption at 100% int.	l/min	121
Air consumption at 100% int.	cfm	4.23
Air consumption at 15% int.	l/min	18
Air consumption at 15% int.	cfm	0.6
Length	mm	113
Weight	kg	1.3

\* A weighted sound pressure level at work station in accordance with EN ISO 15744

\*\* Vibration value according to EN ISO 28927-2

Item ID: **TTDAWM13M**



# EVA TOOL TRAYS

**THE ULTIMATE** CHOICE IN TOOL ORGANISATION

**1**

Choose Your Storage



**2**

Choose Your Tool Trays



**3**

Click Together



Teng Tools EVA foam tool trays are the ultimate choice in tool organisation. The 3-colour EVA foam clearly alerts the user when a tool is out of place, so it can be identified immediately. Purchasing replacement tools for tools that simply cannot be found can end up costing a lot of money. Get Organised with TengTools to avoid these costs.

If you take pride in your work, take pride in your tools. When tools are stored in an organised manner, you see the results with the increase of efficiency and productivity. When you choose Teng Tools you immediately stand out from the crowd as an individual who is ready to succeed.







GET ORGANISED

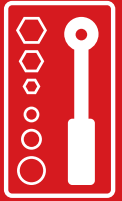

**MADE FROM DURABLE  
ETHYLENE VINYL ACETATE**

Smooth black velvet surface

Laser etching clearly shows where each tool is stored. See the size of a socket at a glance!

Red layer clearly shows what tool has been removed

Depth:

● 0.5mm

● 4mm

● 28mm / 37.5mm





### Storage Trays



Get organised!	
Tray Size	
TEA	

#### STORAGE TRAY



- 7 section storage tray
- Three colour pre-cut EVA foam
- Ideal for storing small items as part of a tool kit or work station
- Removable lid and dove tail joints

Item ID: TEA01



Get organised!	
Tray Size	
	TED

#### STORAGE TRAY



- 8 section storage tray
- Three colour pre-cut EVA foam
- Ideal for storing small items as part of a tool kit or work station

Item ID: TED01



Get organised!	
Tray Size	
TEA	

#### STORAGE TRAY



- 2 section storage tray
- Three colour pre-cut EVA foam
- Ideal for storing small items as part of a tool kit or work station
- Removable lid and dove tail joints

Item ID: TEA02



Get organised!	
Tray Size	
TEX	

#### STORAGE TRAY



- 4 section storage tray
- Three colour pre-cut EVA foam
- Ideal for storing small items as part of a tool kit or work station

Item ID: TEX02



Get organised!	
Tray Size	
TEZ	

#### STORAGE TRAY



- 4 section storage tray
- Three colour pre-cut EVA foam
- Ideal for storing small items as part of a tool kit or work station
- Removable lid and dove tail joints

Item ID: TED00



Get organised!	
Tray Size	
TEZ	

#### STORAGE TRAY



- 3 section storage tray
- Three colour pre-cut EVA foam
- Ideal for storing small items as part of a tool kit or work station

Item ID: TEZ01

## General Tool Kits



Get organised!  
Tray Size  
**TEF**

7 Pieces **EVA**

### PLIER AND HAMMER SET

- Includes pliers, adjustable wrench, knife, tin snips and a claw hammer
- Tools are held in place using three colour pre-cut EVA foam
- Designed to fit exactly in the TengTools TC-SC service case

General Tools:	
TPR Grip Pliers:	6" side cutters, 8" long nose pliers, 10" quick set water pump pliers
Wrenches	8" wide jaw adjustable wrench
Cutting Tools:	Utility knife, straight cut high leverage tin snips
Hammers:	16 oz claw hammer

Item ID: **TEFMB7**



Get organised!  
Tray Size  
**TEF**

7 Pieces **EVA**

### PLIER AND HAMMER SET

- Includes pliers, adjustable wrench, knife, tin snips and a ball peen hammer
- Tools are held in place using three colour pre-cut EVA foam
- Designed to fit exactly in the TengTools TC-SC service case

General Tools:	
TPR Grip Pliers:	6" side cutters, 8" long nose pliers, 10" quick set water pump pliers
Wrenches	8" wide jaw adjustable wrench
Cutting Tools:	Utility knife, straight cut high leverage tin snips
Hammers:	16 oz ball peen hammer

Item ID: **TEFMBP7**



Get organised!  
Tray Size  
**TTE**

25 Pieces **EVA**

### GENERAL TOOL SET

- Includes measuring, striking and cutting tools as well as all the most commonly used pliers
- Tools are held in place using three colour pre-cut EVA foam
- Designed to fit exactly in the larger TengTools tool box drawers

General Tools:	
Cutting Tools:	12" hacksaw, craft knife with 10 spare 18mm snap off blades
Striking Tools:	Soft face hammer, 500g engineers style hammer, parallel pin punches (3, 4, 5, 6, 7, 8mm)
Pliers:	6" heavy duty side cutters, 7" high leverage combination pliers, 6" long nose pliers, 10" water pump pliers
Measuring Tools:	3 meter measuring tape

Item ID: **TTEPS25**



Get organised!  
Tray Size  
**TTE**

15 Pieces **EVA**

### GENERAL TOOL SET

- Includes hack saw, measuring tape, parallel pin punches well as a range of pliers with TPR grip
- Tools are held in place using three colour pre-cut EVA foam
- Designed to fit exactly in the larger TengTools tool box drawers

General Tools:	
General Tools:	12" hacksaw, 3M measuring tape, Parallel Pin Punch Set
TPR Grip Pliers:	8" heavy duty side cutters, 8" heavy duty combination pliers, 8" long nose pliers, 10" water pump pliers

Item ID: **TTEPS15**



Get organised!  
Tray Size  
TTE

27 Pieces



### GENERAL TOOL SET

- Includes measuring, striking and cutting tools as well as adjustable wrenches
- Tools are held in place using three colour pre-cut EVA foam
- Designed to fit exactly in the larger TengTools tool box drawers

General Tools:	
Cutting Tools:	12" hacksaw, craft knife with 10 spare 18mm snap off blades
Striking Tools:	800gm engineers hammer, soft face hammer, cold chisels (150x18mm, 200x25mm), 150x5mm centre punch, parallel pin punches (3, 4, 5, 6, 7, 8mm)
Wrenches	6" and 10" adjustable wrenches
Measuring Tools:	3 meter measuring tape, 200mm steel rule

Item ID: TTEPS12



Get organised!  
Tray Size  
TTE

17 Pieces

mm



### GENERAL TOOL SET

- Includes combination spanners, screwdrivers, hex keys, an adjustable wrench and a claw pick up tool
- Tools are held in place using three colour pre-cut EVA foam
- Designed to fit exactly in the larger TengTools tool box drawers
- Designed and manufactured to DIN and ISO standards

Combination Spanners:													
8, 10, 11, 12, 13, 14, 15, 16, 17, 18, 19 mm													
General Tools:													
Wrenches	8" wide jaw adjustable												
Ball point hex keys:	1.5, 2, 2.5, 3, 4, 5, 6, 8, 10 mm												
Accessories:	600mm claw pick up tool												
Screwdrivers:	<table border="1"> <tr><td>⊖</td><td>3.5x75 mm</td><td>⊕</td><td>PH1x75 mm</td><td>⊕</td><td>PZ1x75 mm</td></tr> <tr><td></td><td>5.5x150 mm</td><td></td><td>PH2x100 mm</td><td></td><td>PZ2x100 mm</td></tr> </table>	⊖	3.5x75 mm	⊕	PH1x75 mm	⊕	PZ1x75 mm		5.5x150 mm		PH2x100 mm		PZ2x100 mm
⊖	3.5x75 mm	⊕	PH1x75 mm	⊕	PZ1x75 mm								
	5.5x150 mm		PH2x100 mm		PZ2x100 mm								

Item ID: TTESP28



Get organised!  
Tray Size  
TTE

17 Pieces

mm



### GENERAL TOOL SET

- Includes a 1/2" drive torque wrench, hex and TX keys and a selection of inspection tools
- Tools are held in place using three colour pre-cut EVA foam
- Designed to fit exactly in the larger TengTools tool box drawers

T Handle Hex Keys:	
	2.5, 3, 4, 5, 6, 7, 8 mm
Hex & TX Keys:	
	1.5, 2, 2.5, 3, 4, 5, 6, 7, 8, 10 mm
	TX8, TX9, TX10, TX15, TX20, TX25, TX27, TX30, TX40
Fold Up Key Set:	
4, 5, 6mm Hex, TX25, TX30, 5.5mm Flat, PH1, PZ2	
General Tools:	
Torque Wrench:	1/2" drive, Range: 40-200Nm
Inspection Tools:	Magnifying glass & mirror (telescopic with extension up to 85cm), LED torch, Hook and pick set
Pick Up Tools	Magnetic pick up, Aluminium handle with interchangeableawl, Hook tools: 45° and 90°

Item ID: TTEX17



## Socket Sets

**NEW**



**1/4" DRIVE 87 Pieces mm AF**

### SOCKET SET

- Gearless palm ratchet, accessories and a bi-flex wrench
- 1/4" drive regular 6 point sockets in metric and AF
- 1/4" drive deep 6 point sockets
- A selection of 25mm long bits

Gearless palm ratchet, 3" extension bar, 1/4"Mx1/4"Hex adaptor, Bi Flex wrench									
6 point sockets:									
Reg mm:	5	5.5	6	7	8	9	10	11	
	11	12	13						
Reg AF:	1/4"	5/16"	3/8"						
Deep mm:	6	7	8	9	10	11	12	13	
1/4" Hex bits: Length 25mm		3.5, 4, 4.5, 5.5 (x2), 6.5, 8				PZ1 (x3), PZ2 (x6), PZ3			
		PH1 (x3), PH2 (x6), PH3				2, 3, 4, 5, 6, 8 mm			
		TX6, TX7, TX8, TX9, TX10, TX15, TX20(x3), TX25(x3), TX27, TX30, TX40							
		TPX10, TPX15, TPX20 (x2), TPX25 (x2), TPX27, TPX30, TPX40							
		ROB1, 2, 3			PH2G				

Item ID: **TEA1487**



**1/4" DRIVE 89 Pieces mm EVA**

### SOCKET SET

- 1/4" drive regular and deep sockets
- A comprehensive range of 1/4" hex drive 25mm bits
- Supplied in the unique TengTools double width TC tray
- Tools are held in place using three colour pre-cut EVA foam clearly showing where each tool belongs
- Designed and manufactured to DIN and ISO standards

72 Teeth ratchet, Universal Joint, Spinner handle, 2" & 4" Extension bars										
Coupler adaptor, 3/8"F x 1/4"M T-bar adaptor, 1/4"M x 1/4" Hex adaptor										
6 point sockets:										
Reg mm:	4	5	5.5	6	7	8	9			
	10	11	12	13						
Deep mm:	4	5	5.5	6	7	8	9			
	10	12	13							
1/4" drive bit sockets:										
1/4" Hex bits:		mm:	4	5.5	7					
		TX:	10	15	20	25	27	30	40	
		PZ:	1	2	3					
		PH:	0	1	2	3				
		3, 4, 5.5, 7			TX8, TX10, TX15, TX20, TX25, TX27, TX30					
		TPX10, TPX15, TPX20, TPX25, TPX27, TPX30, TPX40								
	PZ0, PZ1, PZ2, PZ3				PH0, PH1, PH2, PH3, PH4					
	mm: 3, 4, 5, 6, 8, 10				1/8, 9/64, 5/32, 3/16, 1/4, 5/16					
	XZN: 5, 6									

Item ID: **TED1489**





**3/8" DRIVE** 36 Pieces mm EVA

### SOCKET SET

- 3/8" drive regular length sockets
- A range of 3/8" drive socket bits covering hex and TX sizes
- Tools are held in place using three colour pre-cut EVA foam clearly showing where each tool belongs
- Designed and manufactured to DIN and ISO standards

72 Teeth ratchet, Universal Joint, 3" Wobble extension bar,										
1/2" F x 3/8" M T-bar adaptor, 10" Spinner handle										
Regular 6 point sockets:										
	mm:	8	9	10	11	12	13	14	15	16
		17	18	19	22					
3/8" Drive bit sockets:										
	TX:	10	15	20	25	27	30	40	45	50
	mm:	3	4	5	5.5	6	7	8	10	12

Item ID: TED3836



**1/2" DRIVE** 27 Pieces mm EVA

### SOCKET SET

- 1/2" drive regular and deep sockets
- Supplied in the unique TengTools double width TC tray
- Tools are held in place using three colour pre-cut EVA foam clearly showing where each tool belongs
- Designed and manufactured to DIN and ISO standards

72 Teeth ratchet, 2 1/2" & 6" Extension bars										
Universal joint, 3/8" F x 1/2" M T-bar adaptor										
12 point sockets:										
	Reg mm:	10	11	12	13	14	15	16	17	18
		19	22	24						
	Deep mm:	10	11	12	13	14	15	16	17	18
		19								

Item ID: TED1227

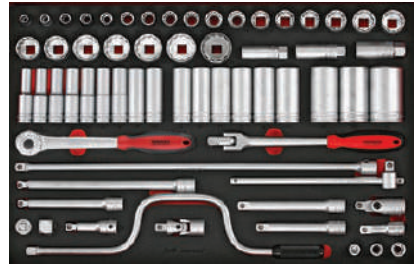

**1/2" DRIVE** 63 Pieces mm EVA

### SOCKET SET

- 1/2" drive regular and deep 12 point bi-hexagon sockets
- Tools are held in place using three colour pre-cut EVA foam clearly showing where each tool belongs
- Designed to fit exactly in the larger TengTools tool box drawers
- Can be used as a set on its own or as part of the TengTools "Get Organised" system
- Designed and manufactured to DIN and ISO standards

72 Teeth ratchet, 2 1/2", 5", 6" & 20" Extension bars, 3", 6" & 10" Wobble extension bars										
Universal joint, 1/2" F x 3/8" M adaptor, 1/2" F x 3/4" M adaptor										
Coupler adaptors for 5/16", 10mm & 12mm bits, Flex head adaptor										
12 point sockets:										
	Reg mm:	8	9	10	11	12	13	14	15	16
		17	18	19	20	21	22	24	25	26
		27	28	29	30	32	34			
	Deep mm:	10	11	12	13	14	15	16	17	18
		19	20	21	22	24	27	30	32	36

Item ID: TTESK63



**13 Pieces** mm EVA

### EXTENSION BARS SET

- Includes a selection of long and wobble extension bars
- TengTools T-HD handle included for a more comfortable grip
- Tools are held in place using three colour pre-cut EVA foam clearly showing where each tool belong
- Designed and manufactured to DIN and ISO standards

1/4" Drive	6" & 12" Extension bars, Universal joint
3/8" Drive	3" Wobble extension bar, 20" Extension bar, Universal joint, 3/8" F x 1/4" M T-bar adaptor
1/2" Drive	3" Wobble extension bar, 20" Extension bar, Universal joint
T-handle grip, 2mm & 2.5mm Mini Hex Screwdrivers	

Item ID: TEXEXT13



**RATCHET & ACCESSORIES SET**

- Quick release and twist reverse action for easier use
- Sliding T bar and 16" (400mm) extension also included
- Tools are held in place using three colour pre-cut EVA foam clearly showing where each tool belong
- Designed and manufactured to DIN and ISO standards

Quick release 72 teeth ratchet, 400mm Extension bar
Sliding T-bar

Item ID: **TEX3403**



**SOCKET SET**

- Chrome vanadium
- Satin finish for a better grip when handling the sockets
- 6 point single hexagon sockets for a better grip
- Tools are held in place using three colour pre-cut EVA foam clearly showing where each tool belongs
- Designed and manufactured to DIN3120/3124



Regular 6 point sockets:							
	mm:	22	24	27	30	32	36
		38	41	46	50		

Item ID: **TEX3410**



**SOCKET SET**

- 3/4" drive regular sockets
- With safety locking system to avoid tools being dropped
- Tools are held in place using three colour pre-cut EVA foam clearly showing where each tool belongs
- Can be used as a set on it's own or as part of the TengTools "Get Organised" system
- Designed and manufactured to DIN and ISO standards

Quick release 72 teeth ratchet, 400mm Extension bar										
Sliding T-bar, 19" Flex handle										
Regular 6 point sockets:										
	mm:	19	21	22	24	27	30	32	33	34
		36	38	41	46	50				
Regular 12 point sockets:										
	AF:	7/8	15/16	1	1-1/16	1-1/8	1-3/16	1-1/4	1-5/16	1-3/8
		1-7/16	1-1/2	1-5/8	1-3/4	1-7/8				

Item ID: **TTEK32**

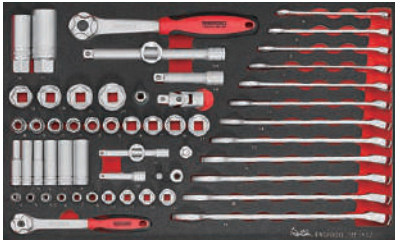

1/4" DRIVE 3/8" DRIVE 57 Pieces mm EVA

### SOCKET SET

- Spanner and socket set
- Tools are held in place using three colour pre-cut EVA foam clearly showing where each tool belongs
- Designed to fit exactly in the TengTools TC-SC service case
- Can be used as a set on it's own or as part of the TengTools "Get Organised" system
- Designed and manufactured to DIN and ISO standards

1/4" Drive	72 Teeth ratchet, 2" & 3" extension bars, 3/8"F x 1/4"M adaptor, 1/4"Hex x 1/4"M adaptor, Coupler adaptor, Universal joint										
3/8" Drive	72 Teeth ratchet, 3" & 6" Extension bars, 1/2"F x 3/8"M adaptor, Coupler adaptor, Universal joint										
1/4" Drive 6 point sockets:											
Reg mm:	4	5	5.5	6	7	8	10	11	12		
	13										
Deep mm:	6	7	8	10	12	13					
3/8" Drive 6 point sockets:											
Reg mm:	8	9	10	11	12	13	14	15	16		
	17	18	19	21	22						
Spark plug sockets mm:	16	21									
Combination Spanners:	8, 9, 10, 11, 12, 13, 14, 15, 16, 17, 18, 19 mm										

Item ID: TEF5K57

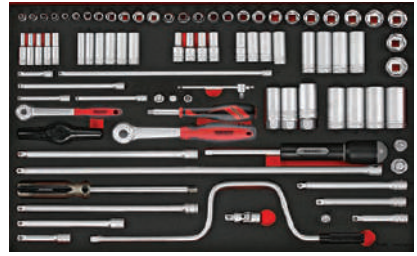

1/4" DRIVE 3/8" DRIVE 86 Pieces mm EVA

### SOCKET SET

- Includes 72 teeth quick release, twist reverse ratchets
- Speed brace for quickly transporting nuts and bolts
- A selection of extension bars and accessories
- Tools are held in place using three colour pre-cut EVA foam clearly showing where each tool belongs
- Can be used as a set on it's own or as part of the TengTools "Get Organised" system
- Designed and manufactured to DIN and ISO standards

1/4" Drive	72 Teeth ratchet, 6" Spinner handle, Universal joint, Coupler adaptor, 2", 3", 4", & 12" Extension bars, 1/4"F x 3/8"M adaptor, Sliding T-bar, T-bar handle adaptor										
3/8" Drive	72 Teeth ratchet, Speed brace, Spinner handle, Universal Joint, 3", 5", 6", 10" & 20" Extension bars, 3/8"F x 1/4"M adaptor, 3/8"F x 1/2"M adaptor, Coupler adaptor										
1/4" Drive 6 point sockets:											
Reg mm:	4	4.5	5	5.5	6	7	8	9	10		
	11	12	13								
Deep mm:	4	5	5.5	6	7	8	9	10	11		
	12	13									
3/8" Drive 6 point sockets:											
Reg mm:	7	8	9	10	11	12	13	14	15		
	16	17	18	19	20	21	22				
Deep mm:	7	8	9	10	11	12	13	14	15		
	16	17	18	19	20	21	22				
Spark plug sockets mm:	16	18	21								



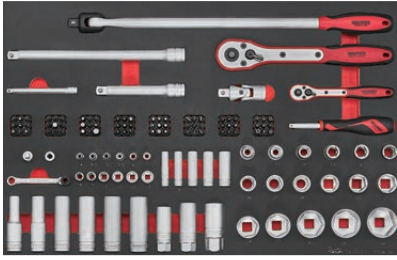





Item ID: TTESK86



**1/4" DRIVE** **1/2" DRIVE** **126 Pieces** **mm** **EVA**

**SOCKET SET**

- Includes FRP quick release, flip reverse ratchets
- Includes a wide selection of 25mm screwdriver bits together with adaptors and the mini bits ratchet
- Tools are held in place using three colour pre-cut EVA foam clearly showing where each tool belongs
- Can be used as a set on it's own or as part of the TengTools "Get Organised" system
- Designed and manufactured to DIN and ISO standards

1/4" Drive	Flip reverse ratchet, Mini bits ratchet, 4" Extension bar, Universal joint 6" Spinner handle, Coupler adaptor, 1/4"M x 1/4"Hex adaptor									
1/2" Drive	Flip reverse ratchet, 17" Flex handle, 5" & 10" Extension bars, Universal joint									
1/4" Drive 6 point sockets:										
Reg mm:	4	4.5	5	5.5	6	7	8	9	10	
	11	12	13							
Deep mm:	7	8	10	11	13					
1/2" Drive 6 point sockets:										
Reg mm:	10	11	12	13	14	15	16	17	18	
	19	20	21	24	27	30	32	34		
Deep mm:	10	13	16	17	18	19				
Spark plug sockets mm:	16	18	21							
1/4" Hex bits:	 3.5, 4, 4.5, 5.5 (x2), 6.5 (x2), 8 mm  TPX10, TPX15, TPX20 (x2), TPX25 (x2), TPX27, TPX30, TPX40  TX6, TX7, TX8, TX9, TX10, TX15, TX20 (x3), TX25 (x3), TX27, TX30 (x2), TX40  PH1 (x4), PH2 (x7), PH3 (x2)  PZ1 (x4), PZ2 (x7), PZ3  2, 3, 4, 5, 6, 8  1, 2, 3  PH2G (x3)									

Item ID: **TTESK126**



**1/4" DRIVE** **3/8" DRIVE** **1/2" DRIVE** **77 Pieces** **mm** **EVA**

**SOCKET SET**

- Includes FRP quick release, flip reverse ratchets
- A selection of extension bars and adaptors to suit different applications
- Tools are held in place using three colour pre-cut EVA foam clearly showing where each tool belongs
- Can be used as a set on it's own or as part of the TengTools "Get Organised" system
- Designed and manufactured to DIN and ISO standards

1/4" Drive	Flip reverse ratchet, 6" Spinner handle, 6" & 12" Extension bars, Universal joint, T-bar & T-bar handle adaptor										
3/8" Drive	Flip reverse ratchet, 3" Wobble extension bar, 6" Extension bar, Universal joint, 3/8"F x 1/4"M adaptor, 3/8"F x 1/2"M adaptor, Rotating spinner handle										
1/2" Drive	Flip reverse ratchet, 6" Wobble extension bar, 10" Extension bar, Universal joint, 1/2"F x 3/8"M adaptor										
1/4" Drive 6 point sockets:											
Reg mm:	4	5	5.5	6	7	8	9	10	11		
	12	13									
Deep mm:	6	7	8	10	12	13					
3/8" Drive 6 point sockets:											
Reg mm:	8	9	10	11	12	13	14	15	16		
	17	18	19	22							
1/2" Drive 12 point sockets:											
Reg mm:	10	11	12	13	14	15	16	17	18		
	19	22									
1/2" Drive 6 point ANSI impact sockets: 											
Reg mm:	13	15	16	17	18	19	22	24			
	13	15	16	17	18	19	22	24			

Item ID: **TTESK77**



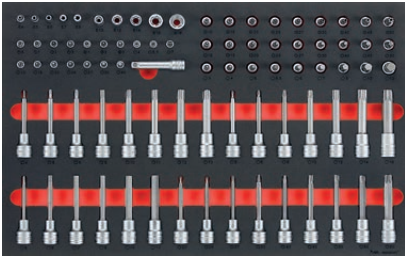

1/4" DRIVE 3/8" DRIVE 1/2" DRIVE 85 Pieces mm EVA

### SOCKET SET

- An extensive range of short and long reach screwdriver, hex and TX bits
- Tools are held in place using three colour pre-cut EVA foam clearly showing where each tool belongs
- Designed to fit exactly in the larger TengTools tool box drawers
- Can be used as a set on it's own or as part of the TengTools "Get Organised" system
- Designed and manufactured to DIN and ISO standards

3/8" Drive	3" Extension bar											
1/4" Drive bit sockets:												
	mm:	4	5.5	7								
	PZ:	1	2	3								
	PH:	0	1	2	3							
	TX:	10	15	20	25	27	30	40				
	TX-E:	E4	E5	E6	E7	E8						
3/8" Drive bit sockets:												
	TX:	10	15	20	25	27	30	40	45	50		
	TPX:	10	15	20	25	27	30	40	45	50		
	TX-E:	E10	E12	E14	E16	E18						
	Hex:	3	4	5	5.5	6	7	8	10	12		
1/2" Drive bit sockets:												
	TX:	20	25	27	30	40	45	50	55	60		
	Long Hex:	5	6	7	8	10	12					
	Ribe:	4	5	6	8	10	11	12	13			
	XZN:	M5	M6	M8	M10	M12	M14	M16				

Item ID: TTESK85



1/2" DRIVE 21 Pieces mm EVA

### IMPACT SOCKET SET

- ANSI standard design for use with power tools with a ball bearing socket retainer
- Selection of extension bars and adaptors
- Supplied in the unique TengTools double width TC tray
- Tools are held in place using three colour pre-cut EVA foam clearly showing where each tool belongs

3" & 10" Extension bars, Universal joint, 3/8" F x 1/2" M & 1/2" F x 3/4" M Impact adaptors												
1/2" Drive Impact 6 point sockets:												
	Reg mm:	13	15	16	17	18	19	22	24			
	Deep mm:	13	15	16	17	18	19	22	24			

Item ID: TED9121



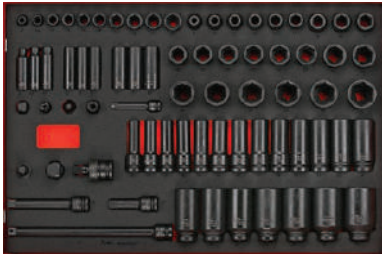



**3/8" DRIVE** **1/2" DRIVE** **73 Pieces** **mm** **EVA**

**IMPACT SOCKET SET**

- Extension bars and adaptors included
- DIN & ANSI standard 1/2" drive sockets included
- Chrome molybdenum for use with power tools
- Designed to fit exactly in the larger TengTools tool box drawers
- Can be used as a set on it's own or as part of the TengTools "Get Organised" system
- Retaining rings and pins included

3/8" Drive	3" Extension bar, 3/8"F x 1/2"M & 3/8"F x 1/4"F Impact adaptors, Coupler adaptor for 1/4" hex bits										
1/2" Drive	3", 5" & 10" Extension bars, Universal joint, 1/2"F x 3/4"M & 1/2"F x 3/8"M Impact adaptors, Coupler adaptor for 5/16" hex bits										
Retaining rings & pins: 092194, 092244, P92320, P92325 x1											
3/8" Drive Impact 6 point sockets: 											
Reg mm:	8	10	11	12	13	14	15	16	17		
	19										
Deep mm:	8	10	11	12	13	14	16	17	19		
1/2" Drive Impact 6 point sockets: 											
Reg mm:	8	10	11	12	13	14	15	16	17		
	18	19	20	21	22	23	24	25	26		
	27	28	29	30	32						
Deep mm:	10	11	12	13	14	15	16	17	18		
	19	21	22	24	27	28	29	30	32		
	35	36									

Item ID: TTEISK73



**3/4" DRIVE** **33 Pieces** **mm** **EVA**

**IMPACT SOCKET SET**

- Extension bars and adaptors included
- DIN standard design for use with a retaining pin and ring
- Chrome molybdenum for use with power tools
- Designed to fit exactly in the larger TengTools tool box drawers
- Can be used as a set on it's own or as part of the TengTools "Get Organised" system
- Retaining rings and pins included

7" Extension bar, Universal joint, 3/4"F x 1/2"M & 3/4"F x 1"M Impact adaptors										
Retaining rings & pins: 095036, P90435 x2										
3/4" Drive Impact 6 point sockets: 										
Reg mm:	19	21	22	23	24	27	28	30	32	
	33	34	36	38	41	46				
Deep mm:	19	21	22	23	24	27	30	32	33	
	34	36	38	41	46					

Item ID: TTEISK33

**Torque Tools**









**NEW**



**1/4" DRIVE** **38 Pieces**

**TORQUE SCREWDRIVER SET**

- 1-5 Nm torque screwdriver with accessories
- Supplied in the unique TengTools single TC tray
- Tools are held in place using three colour pre-cut EVA foam clearly showing where each tool belongs

1-5Nm Torque screwdriver, 1/4"Mx1/4"Hex adaptor				
1/4" Hex bits: Length 25mm		3, 4.5, 5.5, 6.5	 PH0, PH1, PH2, PH3	 PH2G
		2, 3, 4, 5, 6	 PZ0, PZ1, PZ2, PZ3	 ROB1, 2, 3
		TX9, TX10, TX15, TX20, TX25, TX27, TX30, TX40		
		TPX10, TPX15, TPX20, TPX30, TPX40		

Item ID: TEASD38



**NEW**



95 Pieces **EVA**

### TORQUE SCREWDRIVER SET

- 1-5 Nm torque screwdriver with accessories
- Ratcheting bits driver set included
- Supplied in the unique TengTools double width TC tray
- Tools are held in place using three colour pre-cut EVA foam clearly showing where each tool belongs

1/4" Drive	1-5 Nm Torque screwdriver, Quick release chuck, Sliding T-bar, 6" Flexible extension, Ratcheting bits driver with assorted bits, 1/4"M:1/4" hex adaptor		
3/8" Drive	3/8"M x 5/16" Hex adaptor		
1/2" Drive	Reversible impact driver, 5/16" Hex bit adaptor		
5/16" Hex bits: Length 36mm		6, 8, 10, 12	TX30, TX40, TX45, TX50, TX55
		4, 5, 6, 8	PH1, PH2, PH3, PH4
1/4" Hex bits: Length 25mm		3.5, 4, 4.5, 5.5 (x2), 6.5, 8	PH1 (x3), PH2 (x6), PH3
		PZ1 (x3), PZ2 (x6), PZ3	2, 3, 4, 5, 6, 8
		1, 2, 3	PH2G (x3)
		TX6, TX7, TX8, TX9, TX10, TX15, TX20 (x3), TX25 (x3), TX27, TX30, TX40	
		TPX10, TPX15, TPX20 (x2), TPX25 (x2), TPX27, TPX30, TPX40	

Item ID: **TEDSD14**



3/8" DRIVE 1/2" DRIVE 2 Pieces **EVA**

### TORQUE WRENCH SET

- Equipped with an in-built angular gauge for easier after tightening
- Click type mechanism to signal when the required torque is reached
- Additional ft/lb reference scale
- Marked to show the correct place where pressure should be applied
- Twist locking facility to ensure the set torque is maintained
- Reversible 24 teeth ratchet (DIN3122) giving 15° increments
- Designed to torque right hand (clockwise) fasteners
- Accurate to +/- 4% conforms to ISO6789 for assured accuracy
- Individually tested and certified at the time of manufacture
- Tools are held in place using three colour pre-cut EVA foam

Torque Wrenches	
3/8" Drive	20-110Nm (15-81ft/lb)
1/2" Drive	40-210Nm (30-150 ft/lb)

Item ID: **TEX1238**



1/2" DRIVE 3/4" DRIVE 2 Pieces **EVA**

### TORQUE MULTIPLIER SET

- Includes a 1/2" drive torque wrench giving a range of 40 to 210Nm
- The MP1400 torque multiplier can then be used to multiply the torque at a ratio of 3:1 increasing the potential torque to 630Nm
- For use with 3/4" drive sockets
- Tools are held in place using three colour pre-cut EVA foam

1/2" Drive Torque wrench (40-210Nm, 30-150 ft/lb)

1/2"F:3/4"M Torque multiplier (3 to 1 ratio) and maximum torque capacity 1,500Nm

Item ID: **TEXMP12**

## Spanners & Wrenches



12 Pieces **mm** **EVA**

### ANTI SLIP COMBINATION SPANNER SET

- Off set at 15° for easier use on flat surfaces
- TengTools hip grip design on the ring and open end for contact with the flat side of the fastening
- TengTools anti slip design on the open end to give a much better grip
- Tools are held in place using three colour pre-cut EVA foam

Combination Spanners:

8, 9, 10, 11, 12, 13, 14, 15, 16, 17, 18, 19 mm



Item ID: **TED8012**

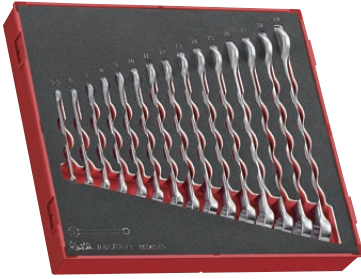

**COMBINATION SPANNER SET**

15 Pieces mm EVA

- Off set at 15° for easier use on flat surfaces
- TengTools hip grip design for contact with the flat side of the fastening
- Tools are held in place using three colour pre-cut EVA foam
- Designed and manufactured to DIN3113A

Combination Spanners:
5.5, 6, 7, 8, 9, 10, 11, 12, 13, 14, 15, 16, 17, 18, 19 mm

Item ID: **TED6515**



**COMBINATION SPANNER SET**

7 Pieces mm EVA

- Chrome vanadium, satin finish
- Off set at 15° for easier use on flat surfaces
- TengTools hip grip design for contact with the flat side of the fastening
- Tools are held in place using three colour pre-cut EVA foam
- Designed and manufactured to DIN3113A

Combination Spanners:
20, 21, 22, 24, 27, 30, 32 mm

Item ID: **TEX2032**

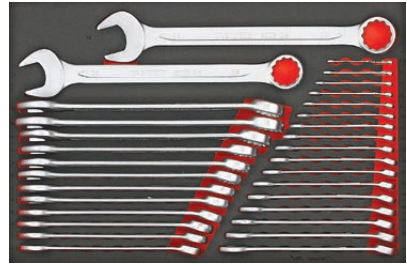

**COMBINATION SPANNER SET**

31 Pieces mm EVA

- Off set at 15° for easier use on flat surfaces
- TengTools hip grip design for contact with the flat side of the fastening
- Chrome vanadium satin finish
- Tools are held in place using three colour pre-cut EVA foam
- Designed to fit exactly in the larger TengTools tool box drawers
- Designed and manufactured to DIN3113A

Combination Spanners:
5.5, 6, 7, 8, 9, 10, 11, 12, 13, 14, 15, 16, 17, 18, 19, 20, 21, 22, 23, 24, 25, 26, 27, 28, 29, 30, 32, 33, 34, 36, 38 mm





Item ID: **TTESP31**



**SOCKET AND SPANNER SET**

62 Pieces AF EVA

- Combination spanners and a range of socketry
- Tools are held in place using three colour pre-cut EVA foam
- TengTools hip grip design for contact with the flat side of the fastening
- Chrome vanadium satin finish
- Designed to fit exactly in the larger TengTools tool box drawers
- Designed and manufactured to DIN and ISO standards

1/4" Drive 6 point sockets:										
	Reg AF:	3/16"	7/32"	1/4"	9/32"	5/16"	11/32"	3/8"	7/16"	1/2"
	Deep AF:	3/16"	7/32"	1/4"	9/32"	5/16"	11/32"	3/8"	7/16"	1/2"
3/8" Drive 6 point sockets:										
	Reg AF:	3/8"	7/16"	1/2"	9/16"	5/8"	11/16"	3/4"		
	Deep AF:	3/8"	7/16"	1/2"	9/16"	5/8"	11/16"	3/4"		
1/2" Drive 12 point sockets:										
	Reg AF:	3/8"	7/16"	1/2"	9/16"	5/8"	11/16"	3/4"	13/16"	7/8"
		15/16"	1"	1-1/8"	1-3/16"	1-1/4"				
Combination Spanners:										
5/16", 3/8", 7/16", 1/2", 9/16", 5/8", 11/16", 3/4", 13/16", 7/8", 15/16", 1", 1-1/16", 1-1/8", 1-1/4"										

Item ID: **TTEAF62**





32 Pieces mm EVA

### COMBINATION SPANNER AND FILE SET

- 72 teeth ratchet spanners, turn over to change direction
- Chrome vanadium satin finish
- The five most used 10" hand files included
- Tools are held in place using three colour pre-cut EVA foam
- Designed to fit exactly in the larger TengTools tool box drawers

Combination Spanners:
8, 9, 10, 11, 12, 13, 14, 15, 16, 17, 18, 19, 20, 21, 22, 24, 27, 30, 32 mm
Ratchet Spanners:
8, 10, 11, 12, 13, 14, 17, 19 mm
10" Engineers Files:
Flat, Round, Half Round, Three Square & Hand Type Flat

Item ID: TTEX32



12 Pieces mm EVA

### RATCHET SPANNER SET

- 72 teeth ratchet spanners giving a 5° increment between clicks
- Reversible ratchet mechanism with hip grip & flip reverse lever
- Tools are held in place using three colour pre-cut EVA foam
- Designed and manufactured to DIN ISO 1711-1 and DIN 3113A

Ratchet Spanners with flip reverse:
8, 9, 10, 11, 12, 13, 14, 15, 16, 17, 18, 19 mm

Item ID: TED6512R



12 Pieces mm EVA

### RATCHET SPANNER SET

- 72 teeth ratchet spanners giving a 5° increment between clicks
- Hip grip on the ring end, turn spanner over to change direction
- Tools are held in place using three colour pre-cut EVA foam
- Designed and manufactured to DIN ISO 1711-1 and DIN 3113A

Ratchet Spanners:
8, 9, 10, 11, 12, 13, 14, 15, 16, 17, 18, 19 mm

Item ID: TED6512RS

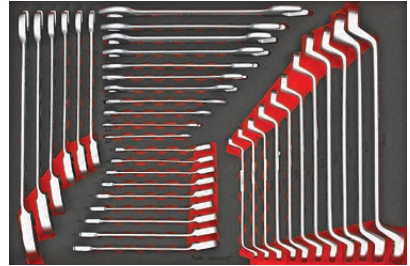

37 Pieces mm EVA

### SPANNER SET

- 72 teeth ratcheting combination spanners with flip reverse lever
- Double open ended and double ring spanners
- Chrome vanadium satin finish
- Tools are held in place using three colour pre-cut EVA foam
- Designed to fit exactly in the larger TengTools tool box drawers
- Designed and manufactured to DIN and ISO standards

Ratchet Spanners:
8, 9, 10, 11, 12, 13, 14, 15, 16, 17, 18, 19, 22, 24, 27 mm
Double Open Ended Spanners:
6x7, 8x9, 10x11, 12x13, 14x15, 16x17, 18x19, 20x22, 21x23, 24x27, 30x32 mm
Double Ring Spanners:
6x7, 8x9, 10x11, 12x13, 14x15, 16x17, 18x19, 20x22, 21x23, 24x27, 30x32 mm

Item ID: TTESP37





8 Pieces **mm** **EVA**

**DOUBLE RING SPANNER SET**

- Different size at each end to give 16 sizes in total
- Double curved heads offset at 75° for easier use on flat surfaces
- Chrome vanadium satin finish
- TengTools hip grip design for contact with the flat side of the fastening
- Tools are held in place using three colour pre-cut EVA foam
- Designed and manufactured to DIN838

Double Ring Spanners:
6x7, 8x9, 10x11, 12x13, 14x15, 16x17, 18x19, 20x22 mm

Item ID: **TEX6308**



6 Pieces **mm** **EVA**

**EXTRA LONG DOUBLE RING SPANNER SET**

- Different size at each end to give 12 sizes in total
- Extra long, flat design for extra torque
- Chrome vanadium satin finish
- TengTools hip grip design for contact with the flat side of the fastening
- Tools are held in place using three colour pre-cut EVA foam
- Designed and manufactured to DIN837

Extra long Double Ring Spanners:
8x10, 11x13, 12x14, 16x18, 17x19, 22x24 mm

Item ID: **TEXFLS06**



7 Pieces **mm** **EVA**

**DOUBLE FLEX WRENCH SET**

- Swivel end wrenches for fast pre-tightening and loosening
- Angle at 90° for added torque when applying the final tightening
- Extra torque for loosening stubborn fastenings
- Tools are held in place using three colour pre-cut EVA foam
- Designed and manufactured to DIN standard

Double Flex Wrenches
8x9, 10x11, 12x13, 14x15, 16x17, 18x19 mm
B-flex Wrench:
1/4" Male x 1/4" Hex Female

Item ID: **TEDDF7**



4 Pieces **EVA** **TPR**

**ADJUSTABLE WRENCH SET**

- Includes regular style 6, 8 and 10" adjustable wrenches
- Also includes an 8" wide jaw adjustable wrench for added versatility
- Tools are held in place using three colour pre-cut EVA foam
- Designed and manufactured to DIN3117 and ISO6787

Adjustable Wrenches	
6" (150 mm)	Capacity: 23.9 mm
8" (200 mm)	Capacity: 28.6 mm
10" (250 mm)	Capacity: 32.8 mm
8" (200 mm) Wide Jaw	Capacity: 38.6 mm

Item ID: **TEDADJ4**



### Screwdrivers



#### SCREWDRIVER SET



- TT-MV PLUS steel alloy for greater strength and material flexibility
- Ergonomically designed bi-material handle for easy use with higher torque
- Hanging hole in the handle for use as a T handle or with a fall protection wire
- The handle is moulded around the blade to give a higher torque capacity
- Tools are held in place using three colour pre-cut EVA foam

Screwdrivers:					
	mm:	3.5 x 100	5.5 x 75	6.5 x 38	5.5 x 125
		6.5 x 100			
	mm:	PH0 x 75	PH1 x 75	PH2 x 38	PH2 x 100
	mm:	PZ1 x 75	PZ2 x 100		

Item ID: TED911N



#### SCREWDRIVER SET



- TT-MV PLUS steel alloy for greater strength and material flexibility
- Ergonomically designed bi-material handle for easy use with higher torque
- Hanging hole in the handle for use as a T handle or with a fall protection wire
- The handle is moulded around the blade to give a higher torque capacity
- Tools are held in place using three colour pre-cut EVA foam

Screwdrivers:					
	mm:	5.5 x 150	6.5 x 150	8 x 150	10 x 200
		mm:	PH3 x 150		

Item ID: TEX915N



#### SCREWDRIVER SET



- TT-MV PLUS steel alloy for greater strength and material flexibility
- Ergonomically designed bi-material handle for easy use with higher torque
- Hanging hole in the handle for use as a T handle or with a fall protection wire
- The handle is moulded around the blade to give a higher torque capacity
- Tools are held in place using three colour pre-cut EVA foam

Screwdrivers:				
	mm:	TX6 x 75	TX8 x 75	TX9 x 75
		TX10 x 100	TX15 x 100	TX20 x 100
		TX25 x 100	TX27 x 100	TX30 x 100

Item ID: TED909TXN

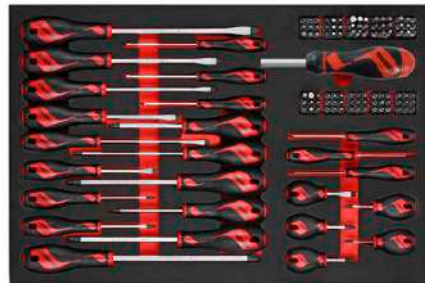

#### SCREWDRIVER SET



- TT-MV PLUS steel alloy for greater strength and material flexibility
- Ergonomically designed bi-material handle for easy use with higher torque
- Hanging hole in the handle for use as a T handle or with a fall protection wire
- The handle is moulded around the blade to give a higher torque capacity
- Tools are held in place using three colour pre-cut EVA foam
- Designed to fit exactly in the larger TengTools tool box drawers
- Can be used as a set on it's own or as part of the TengTools "Get Organised" system

Continued ↗

Screwdrivers:				
mm:	2.5 x 75	3.5 x 75	3 x 100	4 x 100
	5.5 x 75	5.5 x 150	6.5 x 38	6.5 x 100
	6.5 x 150	8 x 150	10 x 200	
mm:	PH0 x 75	PH1 x 38	PH1 x 75	PH2 x 38
	PH2 x 100	PH3 x 150	PH4 x 200	
mm:	PZ0 x 75	PZ1 x 38	PZ1 x 100	PZ2 x 38
	PZ2 x 100	PZ2 x 150	PZ3 x 150	

25 mm Bits:	
mm:	0.6x3.5, 0.6x4.5, 0.8x4 (x2), 0.8x5.5, 1.0x5.5 (x2), 1.2x6.5, 1.6x8
	PH1 (x3), PH2 (x3), PH3 (x3)
	PZ1 (x3), PZ2 (x3), PZ3 (x3)
	6, 7, 8, 9, 10, 15, 20 (x3), 25 (x3), 27, 30, 40
	10, 15, 20 (x2), 25 (x2), 27, 30, 40
	2, 3, 4, 5, 6, 8
	1, 2, 3
	PH2G (x3)
50 mm Bits:	
mm:	0.6x3.5, 0.8x4, 0.8x5.5, 1x5.5, 1.2x6.5
	PH1, PH2 (x2), PH3
	PZ1, PZ2 (x2), PZ3
	8, 10 (x2), 15, 20 (x2), 25 (x2), 27, 30
	4, 5, 6, 8
6 In 1 Ratchetting Bits Driver Set	
Bit Holder For 25 mm Bits	

Item ID: **TTEM122N**





**SCREWDRIVER SET**

- TT-MV PLUS steel alloy for greater strength and material flexibility
- Ergonomically designed bi-material handle for easy use with higher torque
- Hanging hole in the handle for use as a T handle or with a fall protection wire

Continued 

- The handle is moulded around the blade to give a higher torque capacity
- Mini screwdrivers feature a rotating end piece for easier use
- Tools are held in place using three colour pre-cut EVA foam
- Designed to fit exactly in the larger TengTools tool box drawers

Screwdrivers:			
	mm:	2.5 x 75	4 x 100 5.5 x 125
	mm:	PH0 x 60	PH1 x 80 PH2 x 100
	mm:	PZ2 x 100	
	mm:	TX8 x 75	TX9 x 75
	mm:	TPX10 x 100	TPX15 x 100 TPX20 x 200
		TPX25 x 100	TPX30 x 100
Mini Screwdrivers:			
	mm:	2 x 40	2.5 x 40 3 x 40
	mm:	PH00 x 40	PH0 x 40 PH1 x 40
	mm:	TX6 x 40	TX7 x 40 TX8 x 40
		TX9 x 40	TX10 x 40 TX15 x 40
Power Through Screwdrivers:			
	mm:	6.5 x 100	8 x 150 10 x 200
	mm:	PH2 x 100	PH3 x 150

25 mm Bits:	
mm:	0.6x3.5, 0.6x4.5, 0.8x4 (x2), 0.8x5.5, 1x5.5 (x2), 1.2x6.5, 1.6x8
	PH1 (x3), PH2 (x3), PH3 (x3)
	PZ1 (x3), PZ2 (x3), PZ3 (x4)
TX:	6, 7, 8, 10, 15, 20 (x3), 25 (x3), 27, 30, 40
TPX:	10, 15, 20 (x2), 25 (x2), 27, 30, 40
mm:	2, 3, 4, 5, 6, 8
ROB:	1, 2, 3
GR:	PH2G (x3)
6 In 1 Ratchetting Bits Driver Set	
Magnetic Charger For Magnetising / Demagnetising Screwdriver Tips	
1/4" M: 1/4" Hex Adaptor, Coupler Adaptor	

Item ID: **TTEM98N**



**NEW**



Get organised!  
Tray Size  
TTE

33 Pieces mm EVA

### SCREWDRIVER & SPANNER SET

- Selection of screwdrivers with ergonomically designed handles
- Chrome vanadium combination spanners
- Hex key set also included
- Tools are held in place using three colour pre-cut EVA foam

Combination Spanners:	
8, 10, 11, 12, 13, 14, 15, 16, 17, 18, 19 mm	
Hex Key Set:	
1.5, 2.0, 2.5, 3.0, 4.0, 5.0, 6.0, 8.0, 10.0 mm	

Screwdrivers:					
mm:	2.5 x 75	3.5 x 100	4.0 x 100	5.5 x 150	
mm:	PH1 x 75	PH2 x 100			
mm:	TX8 x 75	TX9 x 75			
mm:	TPX10 x 100	TPX15 x 100	TPX20 x 100	TPX25 x 100	TPX30 x 100

Item ID: TTEMD33



Get organised!  
Tray Size  
SC

54 Pieces 1000 V EVA

### SCREWDRIVER & HEX KEY SET

- Selection of screwdrivers with other general tools
- Metric measuring tape
- Tools are held in place using three colour pre-cut EVA foam
- Designed to fit exactly in the TengTools TC-SC service case

Screwdrivers:	
mm:	6.5 x 100
mm:	4 x 101
mm:	PH2 x 100
mm:	PH1 x 81
mm:	P22 x 100
mm:	PZ1 x 81

Ball Point Hex Keys:	
mm:	1.5, 2.0, 2.5, 3.0, 4.0, 5.0, 6.0, 7.0, 10.0
TX Keys:	
TX:	8, 9, 10, 15, 20, 25, 27, 30, 40
25 mm Bits:	
mm:	3.5, 5.5, 8.0
	PH1, PH2, PH3
	PZ1, PZ2, PZ3
	10, 15, 20, 25, 30, 40
	20, 25, 30
	2, 3, 4, 5, 6, 8
	1, 2, 3
7 mm Hose Clip Drivers	
100 mm Quick Chuck Bits Driver	
5 m Measuring Tape - Metric Only	

Item ID: TEFMD54

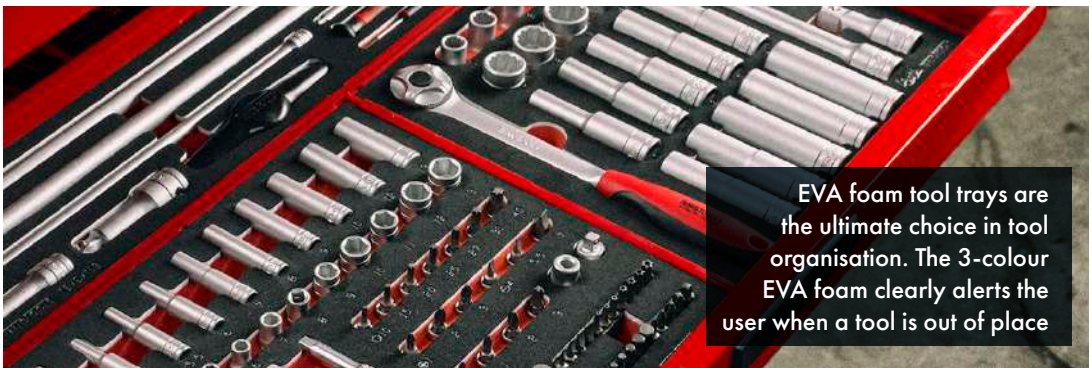



















EVA foam tool trays are the ultimate choice in tool organisation. The 3-colour EVA foam clearly alerts the user when a tool is out of place



**SCREWDRIVER AND HEX KEY SET**

- Selection of screwdrivers with other general tools
- Metric/ Inch measuring tape
- Tools are held in place using three colour pre-cut EVA foam
- Designed to fit exactly in the TengTools TC-SC service case

Screwdrivers:	
	mm: 6.5 x 100
 	mm: 4 x 101
	mm: PH2 x 100
 	mm: PH1 x 81
	mm: PZ2 x 100
 	mm: PZ1 x 81



Ball Point Hex Keys:	
	mm: 1.5, 2.0, 2.5, 3.0, 4.0, 5.0, 6.0, 7.0, 10.0
TX Keys:	
	TX: 8, 9, 10, 15, 20, 25, 27, 30, 40
25 mm Bits:	
	mm: 3.5, 5.5, 8.0
	PH1, PH2, PH3
	PZ1, PZ2, PZ3
	10, 15, 20, 25, 30, 40
	20, 25, 30
	2, 3, 4, 5, 6, 8
	1, 2, 3
7 mm Hose Clip Drivers	
100 mm Quick Chuck Bits Driver	
5 m Measuring Tape - Metric & AF	

Item ID: **TEFMDI54**



**POWER THROUGH SCREWDRIVER SET**

- Chrome vanadium blades for greater strength and material flexibility
- Percussion cap and full length integral blade for use with a hammer to release stubborn screws
- Ergonomically designed bi-material handle for easy use with higher torque
- The handle is moulded around the blade to give a higher torque capacity
- Tools are held in place using three colour pre-cut EVA foam

Screwdrivers:		
	mm: 6.5 x 100	8 x 150 10 x 200
	mm: PH2 x 100	PH3 x 150









Item ID: **TEXMDTN**

**Bits & Driver Sets**



**QUICK CHUCK BITS DRIVER SET**

- Various drivers and accessories for use with bits and/or sockets
- Includes the TengTools mini bits ratchet adaptor for use with the quick chuck bits driver to create a reversible 1/4" drive ratchet
- Tools are held in place using three colour pre-cut EVA foam

147mm Quick chuck driver, 1/4" drive ratchet head adaptor, 1/4" M x 1/4" Hex adaptor, 50mm Bit holder			
1/4" Drive Regular 6 point sockets:			
	mm:	4, 5, 5.5, 6, 7, 8, 9, 10, 11, 12, 13 mm	
1/4" Hex bits:			
Length 25mm:		3.5, 4.0, 4.5, 5.5 (x2), 6.5, 8.0 mm	 PH2G (x3)
		PH1 (x3), PH2 (x6), PH3	 ROB1, 2, 3
		TX6, TX7, TX8, TX9, TX10, TX15, TX20 (x3), TX25 (x3), TX27, TX30, TX40	
		TPX10, TPX15, TPX20 (x2), TPX25 (x2), TPX27, TPX30, TPX40	
		PZ1 (x3), PZ2 (x6), PZ3	 2, 3, 4, 5, 6, 8

Item ID: **TEAMDQ78**





50 Pieces EVA

### IMPACT BIT SET

- Magnetic and quick chuck bit holders included for fast changing
- Designed for higher torsion
- Tools are held in place using three colour pre-cut EVA foam

60mm Impact magnetic bit holder, 60mm Impact quick chuck bit holder			
1/4" Hex Impact Bits: Length 30mm		PH1, PH2 (x2), PH3	
		PZ1, PZ2 (x2), PZ3	
		TX10, TX15, TX20 (x2), TX25 (x2), TX27, TX30 (x2), TX40	
1/4" Hex Impact Bits: Length 50mm		PH1, PH2, PH3	
		PZ1, PZ2, PZ3	
		TX10, TX15, TX20, TX25, TX27, TX30, TX40	

Item ID: TEABS50



7 Pieces EVA

### T HANDLE TX KEY SET

- TPX end on the long key end for use with tamper proof TPX fastenings
- Regular TX end on the short arm giving the ability to apply higher torque
- Tools are held in place using three colour pre-cut EVA foam

T-Handle TX Drivers:		
	100 mm long:	TX/TPX10, TX/TPX15, TX/TPX20
	150 mm long:	TX/TPX25, TX/TPX27, TX/TPX30
	190 mm long:	TX/TPX40

Item ID: TEDTX7

## Hex & TX Keys



7 Pieces EVA mm

### T HANDLE HEX KEY SET

- Ball point end on the long key end giving access at angles of up to 25°
- Regular hex end on the short arm giving the ability to apply higher torque
- Tools are held in place using three colour pre-cut EVA foam

Ball Point T-Handle Hex Drivers:		
	100 mm long:	2.5, 3, 4 mm
	150 mm long:	5, 6, 7 mm
	190 mm long:	8 mm

Item ID: TEDHEX7



42 Pieces EVA mm AF

### HEX, TX AND SCREWDRIVER KEY SET

- Includes metric and inch hex keys
- TX keys and mini TX keys
- Also includes a handy fold up key set including hex, TX and screwdriver blades
- Tools are held in place using three colour pre-cut EVA foam

Ball Point Hex & TX Keys:	
	1.5, 2, 2.5, 3, 4, 5, 6, 7, 8, 10 mm
	5/64", 3/32", 1/8", 5/32", 3/16", 7/32", 1/4", 5/16", 3/8"
	TX8, TX9, TX10, TX15, TX20, TX25, TX27, TX30, TX40
Mini TX Keys:	
	TX6, TX7, TX8, TX9, TX10, TX15
Fold Up Key Set:	
4, 5, 6mm Hex, TX25, TX30, 5.5mm Flat, PH2, PZ2	

Item ID: TEDHT42

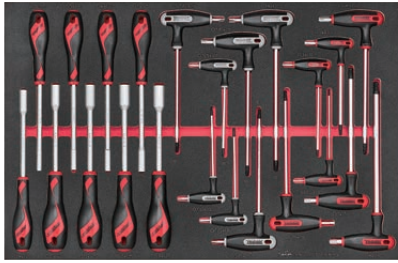



Get organised!  
Tray Size  
TTE

23 Pieces **mm** **EVA**

**NUT AND T HANDLE DRIVER SET**

- Includes metric nut drivers and T handle hex and TX/TPX drivers
- Ergonomically designed bi-material handles for higher torque
- Hanging hole in the handle for use as a T handle for extra torque or with a fall protection wire
- The handle is moulded around the blade which gives a higher torque capacity
- Tools are held in place using three colour pre-cut EVA foam
- Designed to fit exactly in the larger TengTools tool box drawers

Nut Drivers:	
	5, 5.5, 6, 7, 8, 10, 11, 12, 13 mm
T Handle Hex & TX Keys:	
	2.5, 3, 4, 5, 6, 7, 8 mm
	TX/TPX10, TX/TPX15, TX/TPX20, TX/TPX25, TX/TPX27, TX/TPX30, TX/TPX40

Item ID: TTEX23N

**Pliers**



Get organised!  
Tray Size  
TED

5 Pieces **TPR** **EVA**

**PLIER SET**

- TPR grip for a more secure and comfortable grip
- All the most commonly used pliers in one set
- Supplied in the unique TengTools double width TC tray
- Tools are held in place using three colour pre-cut EVA foam clearly showing where each tool belongs

Pliers:	
SIDE CUTTER	5" / 135 mm
HEAVY DUTY SIDE CUTTERS	6" / 160 mm
HIGH LEVERAGE COMBINATION	8" / 200 mm
LONG NOSE	8" / 200 mm
WATER PUMP	10" / 250 mm

Item ID: TED441-T



Get organised!  
Tray Size  
TEX

2 Pieces **EVA**

**PLIER & WRENCH SET**

- 2 tools for gripping even the most stubborn nuts and bolts
- Supplied in the unique TengTools drawer width TEX tray
- Tools are held in place using three colour pre-cut EVA foam clearly showing where each tool belongs

Pliers:	
QUICK ACTION WATER PUMP	10" / 250 mm
Wrenches	
ALIGATOR ADJUSTABLE	8" / 200 mm

Item ID: TEXMB02

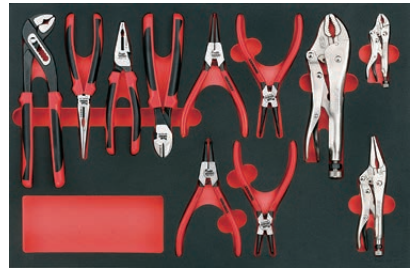

Get organised!  
Tray Size  
TTE

11 Pieces **TPR** **EVA**

**PLIER SET**

- Includes all the most commonly used pliers, circlip pliers and power grip pliers in one set
- Tools are held in place using three colour pre-cut EVA foam clearly showing where each tool belongs
- Designed to fit exactly in the larger TengTools tool box drawers
- Can be used as a set on it's own or as part of the TengTools "Get Organised" system

Pliers:	
HEAVY DUTY SIDE CUTTERS	8" / 200 mm
HIGH LEVERAGE COMBINATION	7" / 180 mm
LONG NOSE	8" / 200 mm
WATER PUMP	10" / 250 mm
Circlip Pliers:	
STRAIGHT INNER	7" / 175 mm
BENT INNER	7" / 175 mm
STRAIGHT OUTER	7" / 175 mm
BENT OUTER	7" / 175 mm
POWER GRIP Pliers:	
LONG NOSE STRAIGHT JAW	6" / 155 mm
REGULAR CURVED JAW	4" / 100 mm
	10" / 250 mm

Item ID: TTEMB11



Get organised!

Tray Size

TTE

### PLIER SET

17 Pieces

TPR EVA

- Includes all the most commonly used pliers in one set
- TPR grip for a more secure and comfortable grip
- Tools are held in place using three colour pre-cut EVA foam clearly showing where each tool belongs
- Designed to fit exactly in the larger TengTools tool box drawers
- Can be used as a set on it's own or as part of the TengTools "Get Organised" system

Pliers:	
SIDE CUTTERS	5" / 135 mm
	6" / 155 mm
HEAVY DUTY SIDE CUTTERS	6" / 160 mm
	8" / 200 mm
OFFSET HEAVY DUTY SIDE CUTTERS	8" / 200 mm
CABLE CUTTERS	8" / 208 mm
HIGH LEVERAGE COMBINATION	7" / 180 mm
	8" / 200 mm
LONG NOSE	8" / 200 mm
FLAT LONG NOSE	6" / 165 mm
WIRE STRIPPERS	6" / 155 mm
WATER PUMP	7" / 180 mm
	10" / 250 mm
Circlip Pliers:	
STRAIGHT INNER	7" / 175 mm
BENT INNER	7" / 175 mm
STRAIGHT OUTER	7" / 175 mm
BENT OUTER	7" / 175 mm

Item ID: TTEMB17



Get organised!

Tray Size

TTE

### POWER GRIP PLIER SET

11 Pieces

EVA

- Includes all the most commonly used power grip pliers and welding pliers in one set
- Tools are held in place using three colour pre-cut EVA foam clearly showing where each tool belongs
- Designed to fit exactly in the larger TengTools tool box drawers
- Can be used as a set on it's own or as part of the TengTools "Get Organised" system

Power Grip Pliers:	
STANDARD ROUND JAW	4" / 100 mm
	7" / 180 mm
	10" / 250 mm
	12" / 300 mm
STANDARD FLAT JAW	10" / 250 mm
	12" / 300 mm
LONG NOSE	4" / 100 mm
	6" / 155 mm
	9" / 230 mm
C CLAMP PLIER	11" / 285 mm
SELF LEVELLING LOCKING PLIER	12" / 300 mm

Item ID: TTEVG11

## Insulated Tools





**Get organised!**

Tray Size
TED

9 Pieces     

### INSULATED SCREWDRIVER SET

- Approved for live working up to 1,000 volts
- Integrated protective insulation with two colours to clearly indicate if there is any damage
- A 100-250 volt tester is also included for checking circuits
- Tools are held in place using three colour pre-cut EVA foam
- Designed and manufactured to DIN ISO 8764-1, DIN5264 and IEC60900 (EN60900)

100-250V Voltage Tester				
1000V Insulated Screwdrivers:				
 mm:	2.5 x 75	3 x 100	4 x 100	5.5 x 125
 mm:	PH0 x 60	PH1 x 80	PH2 x 100	
 mm:	PZ2 x 100			

Item ID: **TEDV909N**



**Get organised!**

Tray Size
TED

4 Pieces      

### INSULATED PLIER SET

- Approved for live working up to 1,000 volts
- Integrated protective insulation with two colours to clearly indicate if there is any damage
- TPR grip for a more secure and comfortable grip
- Tools are held in place using three colour pre-cut EVA foam
- Designed and manufactured to DIN5745, DIN5746, DIN5749 and IEC60900 (EN60900)

1000V Insulated Pliers:	
SIDE CUTTER	6" / 150 mm
LONG NOSE	8" / 200 mm
COMBINATION PLIERS	8" / 200 mm
WIRE STRIPPING PLIERS	6" / 155 mm

Item ID: **TEDV440**

## Measuring Tools



**Get organised!**

Tray Size
TED

3 Pieces 

### MEASURING TOOL SET

- Ideal for machinists and technicians
- Includes a digital 4 function caliper, micrometer and a dial indicator complete with a magnetic stand
- Tools are held in place using three colour pre-cut EVA foam

Measuring Tools:		
Digital caliper	mm/inch	150mm/6"
Micrometer	mm	0 to 25mm
Dial Indicator with stand		0-25mm measuring range
Magnetic stand with central locking		

Item ID: **TEDIMM**

## Auto Tools



**Get organised!**

Tray Size
TED

### SPARK PLUG SOCKET SET

- Extra long swivelling spark plug sockets for use in hard to reach places
- T bar with the TengTools T-HD handle for more comfortable use

2 Piece T-bar handle				
3/8" Drive extra long swivelling spark plug sockets:				
 mm:	14	16	21	

Item ID: **TEXTB05**



Get organised!

Tray Size
TEX

### WHEEL TOOL SET

5 Pieces



- 17" 1/2" drive flex handle for shifting stubborn wheel nuts
- A short extension bar for reaching into recessed wheel rims
- Long reach sockets with protective nylon sleeves to avoid damage to wheels
- Tools are held in place using three colour pre-cut EVA foam

1/2" Drive Accessories:
17" Flex Handle, 5" Extension bar
Impact Wheel Nut Sockets:
17, 19, 21mm

Item ID: **TEXW05**



Get organised!

Tray Size
TEX

### PRY BAR SET

4 Pieces



- Includes 3 roll/heel bars and a 20" tyre lever
- Tools are held in place using three colour pre-cut EVA foam

Roll heel bars:
12", 16", 20"
Tyre Lever:
20"

Item ID: **TEXPB4**

## Service Tools



Get organised!

Tray Size
TEA

### PUNCH AND CHISEL SET

14 Pieces



- Flat cold chisel made from chrome molybdenum
- Pin punches made from chrome vanadium
- Automatic centre punch with spring loaded stroke for marking points quickly
- Tools are held in place using three colour pre-cut EVA foam

Punches:		
Centre	Length: 150 mm	4, 5, 8 mm, Automatic centre punch
Parallel	Length: 150 mm	3, 4, 5, 6, 7, 8 mm
Flat cold chisels::		
150 mm		Width: 19 mm
200 mm		Width: 25 mm
240 mm		Width: 26 mm
250 mm		Width: 25 mm

Item ID: **TEDPC14**



Get organised!

Tray Size
TEA

### RIVET GUN SET

81 Pieces



- Aluminium alloy and forged steel construction
- Light weight design for more comfortable use
- PVC grip for added comfort
- Suitable for use with 2.4, 3.2, 4.0 and 4.8mm rivets
- Selection of rivets included
- Tools are held in place using three colour pre-cut EVA foam

Hand rivetter:
4 nozzles to suit aluminium/steel blind rivets (2.4, 3.2, 4.0, 4.8 mm)
Aluminium rivets:
2.4mm (3/32") x 20 black
3.2mm (1/8") x 20 black
4.0mm (5/32") x 20 black
4.8mm (3/16") x 20 black
Accessories:
Nozzle wrench

Item ID: **TEAHR81**





DS Techeetah | Formula E World Champions



GET ORGANISED

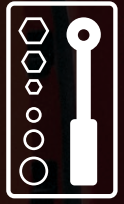

# WALL RACKS

KEEPING YOUR WORKSHOP **IN ORDER**

A comprehensive range of tool holders that are ideal to attach to tool panels above a bench or to mount directly on the wall. The holders are perfect for the storage of tools you use frequently, they create order and make the tools easy to reach.

There is a space marked out for each tool so it is easy to see which tool is missing



Can be attached to tool panels above a work bench or mounted on the wall so that all tools are easy to reach.

All templates and fixings included





## Wall Racks



Get organised!  
Tray Size  
PS

### PRE SET TORQUE WRENCH SET

1/2" DRIVE 4 Pieces

- Click type mechanism to signal when the required torque is reached
- Fixed setting for consistent torque application
- Robust 24 teeth ratchet mechanism for 15° increments
- Rubber grip for added comfort particularly with repeated use
- Accurate to +/- 4% conforms to ISO6789 for assured accuracy
- Individually tested and certified at the time of manufacture
- Rack included for storing the tools on a wall or workbench panel

1/2" Drive Pre Set Torque Wrenches

90, 110, 120, 140 Nm

Item ID: TTPSTQ04



### ANTI SLIP COMBINATION SPANNER SET

12 Pieces mm

- Off set at 15° for easier use on flat surfaces
- TengTools hip grip design on the ring and open end for contact with the flat side of the fastening
- TengTools anti slip design on the open end to give a much better grip
- Supplied with a wall rack for fixing to the wall or a workbench

Anti Slip Combination Spanners:

8, 9, 10, 11, 12, 13, 14, 15, 16, 17, 18, 19 mm



Item ID: WR8012



12 Pieces mm

### COMBINATION SPANNER SET

- Off set at 15° for easier use on flat surfaces
- TengTools hip grip design for contact with the flat side of the fastening
- Chrome vanadium satin finish
- Supplied with a wall rack for fixing to the wall or a workbench
- Designed and manufactured to DIN3113A

Combination Spanners:

8, 9, 10, 11, 12, 13, 14, 15, 16, 17, 18, 19 mm

Item ID: WRSP12



12 Pieces mm

### LONG REACH COMBINATION SPANNER SET

- Extra long for increased torque
- Off set at 15° for easier use on flat surfaces
- TengTools hip grip design for contact with the flat side of the fastening
- Supplied with a wall rack for fixing to the wall or a workbench
- Designed and manufactured to DIN3113A

Extra Long Combination Spanners:

8, 9, 10, 11, 12, 13, 14, 15, 16, 17, 18, 19 mm

Item ID: WRSP12LMP



## RATCHET SPANNER SET

12 Pieces mm

- 72 teeth ratchet spanners giving a 5° increment between clicks
- Simply turn over to reverse the direction of use when ratcheting
- Chrome vanadium satin finish
- Supplied with a wall rack for fixing to the wall or a workbench
- Designed and manufactured to DIN ISO 1711-1 and DIN 3113A

Ratchet Spanners:

8, 9, 10, 11, 12, 13, 14, 15, 16, 17, 18, 19 mm

Item ID: **WRSP12RS**



5 Pieces mm

## LONG DOUBLE RING SPANNER SET

- Different size at each end to give 10 sizes in total
- Extra long, flat design for extra torque and easier access
- Chrome vanadium satin finish
- TengTools hip grip design for contact with the flat side of the fastening
- Supplied with a wall rack for fixing to the wall or a workbench

Extra long Double Ring Spanners:

8x10, 11x13, 12x14, 17x19, 22x24 mm

Item ID: **WRFLS05**



6 Pieces mm

## DOUBLE FLEX WRENCH SET

- Swivel end wrenches for fast pre-tightening and loosening
- Angle at 90° for added torque when applying the final tightening
- Extra torque for loosening stubborn fastenings
- Chrome vanadium satin finish
- Supplied with a wall rack for fixing to the wall or a workbench

Double Flex Wrenches

8x9, 10x11, 12x13, 14x15, 16x17, 18x19 mm

Item ID: **WRDF06**



10 Pieces

## SCREWDRIVER RACK

- TT-MV PLUS steel alloy for greater strength and material flexibility
- Ergonomically designed bi-material handle for easy use with higher torque
- The handle is moulded around the blade to ensure straightness
- Supplied with a wall rack for fixing to the wall or a workbench

SCREWDRIVERS:

	mm:	3 x 100	5.5 x 75	5.5 x 150
		6.5 x 150	8 x 150	
	mm:	PH0 x 75	PH1 x 75	PH2 x 100
	mm:	PZ1 x 75	PZ2 x 100	



Item ID: **WRMD10N**



5 Pieces  

**POWER THROUGH SCREWDRIVER SET**

- Chrome vanadium blades for greater strength
- Percussion cap and full length integral blade for use with a hammer
- Ergonomically designed bi-material handle for easy use with higher torque
- The handle is moulded around the blade to ensure straightness
- Supplied with a wall rack for fixing to the wall or a workbench

SCREWDRIVERS:			
	mm:	6.5 x 100	8 x 150
	mm:	PH2 x 100	PH3 x 150
			10 x 200



Item ID: **WRMDT05N**



7 Pieces  **AF**

**T-HANDLE HEX KEY SET**

- Ball point end on the long key end giving access at angles of up to 25°
- Regular hex end on the short arm to apply higher torque to stubborn fastenings
- Supplied with a wall rack for fixing to the wall or a workbench
- Template and fixings included

Ball Point T-Handle Hex Drivers:		
	100 mm long:	3/32", 1/8", 5/32"
	150 mm long:	3/16", 7/32", 1/4"
	190 mm long:	5/16"



Item ID: **WRHEX07AF**



7 Pieces  **mm**

**T-HANDLE HEX KEY SET**

- Ball point end on the long key end giving access at angles of up to 25°
- Regular hex end on the short arm to apply higher torque to stubborn fastenings
- Supplied with a wall rack for fixing to the wall or a workbench

Ball Point T-Handle Hex Drivers:		
	100 mm long:	2.5, 3, 4 mm
	150 mm long:	5, 6, 7 mm
	190 mm long:	8 mm







Item ID: **WRHEX07**



7 Pieces  

**T HANDLE TX/TPX KEY SET**

- TPX type on the long key end for tamper proof TX fastenings
- Regular TX end on the short arm to apply higher torque to stubborn fastenings
- Supplied with a wall rack for fixing to the wall or a workbench

T-Handle TX Drivers:		
 	100 mm long:	TX/TPX10, TX/TPX15, TX/TPX20
 	150 mm long:	TX/TPX25, TX/TPX27, TX/TPX30
 	190 mm long:	TX/TPX40

Item ID: **WRTX07**





4 Pieces **TPR**

## PLIER SET

- TPR grip for a more secure and comfortable grip
- All the most commonly used pliers in one set
- Supplied with a wall rack for fixing to the wall or a workbench

PLIERS:	
SIDE CUTTER	6" / 155 mm
HIGH LEVERAGE COMBINATION	7" / 180 mm
LONG NOSE	8" / 200 mm
WATER PUMP	10" / 250 mm

Item ID: **WRMB04**



5 Pieces **TPR** 1000V

## INSULATED SCREWDRIVER SET

- Approved for live working up to 1,000 volts
- Protective insulation with two colours to clearly indicate if there is any damage to the insulation
- Supplied with a wall rack for fixing to the wall or a workbench
- Designed and manufactured to DIN5264, DIN ISO 8764-1 and IEC60900 (EN60900)

1000V Insulated Screwdrivers:		
⊖ mm:	3 x 100	5.5 x 125
⊕ mm:	PH1 x 80	PH2 x 100
⊕ mm:	PZ2 x 100	

Item ID: **WRMDV05N**



7 Pieces **TPR** 1000V

## INSULATED SCREWDRIVER SET

- Approved for live working up to 1,000 volts
- Protective insulation with two colours to clearly indicate if there is any damage to the insulation
- Supplied with a wall rack for fixing to the wall or a workbench
- Designed and manufactured to DIN5264, DIN ISO 8764-1 and IEC60900 (EN60900)

100 - 250V Voltage Tester				
1000V Insulated Screwdrivers:				
⊖ mm:	2.5 x 75	3 x 100	4 x 100	5.5 x 125
⊕ mm:	PH1 x 80	PH2 x 100		

Item ID: **WRMDV07N**



4 Pieces **TPR** 1000V

## INSULATED PLIER SET

- Approved for live working up to 1,000 volts
- Protective insulation with two colours to clearly indicate if there is any damage to the insulation
- TPR grip for a more secure and comfortable grip
- Supplied with a wall rack for fixing to the wall or a workbench
- Designed and manufactured to DIN5745, DIN5746, DIN5749 and IEC60900 (EN60900)

1000V Insulated Pliers:	
SIDE CUTTER	6" / 150 mm
HEAVY DUTY SIDE CUTTERS	8" / 200 mm
LONG NOSE	8" / 200 mm
COMBINATION PLIERS	7" / 175 mm

Item ID: **WRMBV04**



**HAND FILE SET**

- 10" high carbon steel hand files
- Bi-material handle for a more comfortable grip
- 2nd cut to create a diamond pattern cutting surface for smoother filing
- Cut on both edges of the flat files for filing grooves, etc
- Supplied with a wall rack for fixing to the wall or a workbench

5 Pieces

10" Files:

Flat, Hand, Half Round, Round, Three square

Item ID: **WRFL05**



10 Pieces

**PUNCH AND CHISEL SET**

- Flat cold chisel made from chrome molybdenum
- Pin punches made from chrome vanadium
- Supplied with a wall rack for fixing to the wall or a workbench

Punches:		
Centre	Length: 150 mm	5 mm
Parallel	Length: 150 mm	3, 4, 5, 6, 7, 8 mm
Flat cold chisels::		
150 mm		Width: 19 mm
200 mm		Width: 25 mm
250 mm		Width: 25 mm

Item ID: **WRPC10**



7 Pieces

**WOOD CHISEL SET**

- Includes a range of blade sizes from 6 to 25mm
- Finely ground and lacquer protected for corrosion protection
- Impact resistant soft grip handle with a percussion cap for striking with a hammer
- Each chisel is supplied with a plastic blade cover for safer storage
- Supplied with a wall rack for fixing to the wall or a workbench

Wood Chisels:

6, 10, 12, 16, 18, 20 & 25 mm

Item ID: **WRWC07**



# SOCKET SETS

ALWAYS **READY FOR ACTION**

A good socket set is one of the most important things to have in your tool collection. Do not try and get away with skimping to save some cash in the short term when choosing a socket set. You can guarantee that when you choose Teng Tools you will not be let down!



Secure lock system with click mechanism so you know the top is closed properly



Hard-wearing hinge with metal pin for increased life





Retractable handle, especially designed for comfort and durability.



Clear layout makes it easier to see which tools are missing



Stand out from the crowd with distinctive Teng Tools branding

Fully recyclable packaging to protect the environment



Rubber feet to prevent the box from sliding and which protects against scratching

Certain sets are supplied with a divider that keeps the tools in place. It is attached by a hinge on the outer edge so it can be moved to one side when using the tool set.







# Socket Sets 1/4" DRIVE



1/4" DRIVE



CLIP RAIL FACILITY



1/4" DRIVE 13 Pieces mm

## SOCKET SET

- A basic no nonsense set of 1/4" drive sockets
- Chrome vanadium
- Satin finish for a better grip when handling the socket
- 6 point single hexagon sockets for a better fit
- Ball bearing recess on the female end to grip the ratchet or power bar
- Designed and manufactured to DIN and ISO standards
- Supplied in a handy pocket sized holder with a clip rail facility for adding additional sockets or accessories

Flip Reverse Ratchet						
2" Extension Bar						
Regular 6 point sockets:						
mm:	4	5	5.5	6	7	8
	9	10	11	12	13	

Item ID: M1413N1



STORE 4x TJ SETS IN 1 TRAY



NEW

1/4" DRIVE 15 Pieces mm

## TJ SOCKET SET

- Socket set that fits into the TTTJ04 tool tray allowing you to store 4 TJ sets in a single tray
- 1/4" drive stubby ratchet and accessories
- 1/4" drive sockets and a selection of bits

Stubby 72 teeth ratchet, 2" extension bar, 1/4"M x 1/4"Hex adaptor							
Regular 6 point sockets:							
mm:	5.5	6	7	8	10	12	13
1/4" Hex bits: Length 25mm	⊖	5.5	⊕	4, 5	⊕	PH1, PH2	

Item ID: TJ1415

USE WITH TTTJ04 STORAGE TRAY

STORE 4x TJ SETS IN 1 TRAY



NEW

1/4" DRIVE 19 Pieces mm

## TJ SOCKET SET

- Socket set that fits into the TTTJ04 tool tray allowing you to store 4 TJ sets in a single tray
- 1/4" drive bits ratchet and accessories
- 1/4" drive sockets and a selection of bits

1/4" bits ratchet, 50mm magnetic bits holder, 1/4"M x 1/4" Hex adaptor

Regular 6 point sockets:

mm:	8	9	10	11	12	13
1/4" Hex bits: Length 25mm	⊖	4.5, 5.5, 6.5	⊕	PH1, PH2		
	⊕	PZ1, PZ2	⊕	4, 5, 6		

Item ID: TJ1419

USE WITH TTTJ04 STORAGE TRAY

STORE 4x TJ SETS IN 1 TRAY



NEW

1/4" DRIVE 20 Pieces mm

## TJ SOCKET SET

- Socket set that fits into the TTTJ04 tool tray allowing you to store 4 TJ sets in a single tray
- 1/4" drive bits ratchet and accessories
- 1/4" drive sockets and a selection of bits

1/4" bits ratchet, 50mm magnetic bits holder, 1/4"M x 1/4" Hex adaptor

Regular 6 point sockets:

mm:	5.5	6	7	8	9	10	13
1/4" Hex bits: Length 25mm	⊖	4.5, 5.5, 6.5	⊕	PH1, PH2			
	⊕	PZ1, PZ2	⊕	TX10, TX15, TX20			

Item ID: TJ1420



**SOCKET SET**

**1/4" DRIVE** **8 Pieces** **mm**

- Regular 6 point single hexagon sockets for a better grip
- Chrome vanadium satin finish sockets
- Supplied in the unique TengTools case with a snap lock
- Hard wearing hinge with a metal pin for longer life
- Designed and manufactured to DIN and ISO standards

Stubby 72 teeth ratchet							
Regular 6 point sockets:							
 mm:	5.5	6	7	8	10	12	13





Item ID: **T1408**



**SOCKET SET**

**1/4" DRIVE** **19 Pieces** **mm**

- Regular 6 point single hexagon sockets for a better grip
- Chrome vanadium satin finish sockets
- A selection of screwdriver and hex bits
- Supplied in the unique TengTools case with a snap lock
- Hard wearing hinge with a metal pin for longer life
- Designed and manufactured to DIN and ISO standards

1/4" Mini bits ratchet							
Magnetic bits holder, 1/4"M x 1/4" Hex adaptor							
Regular 6 point sockets:							
 mm:	8	9	10	11	12	13	
1/4" Hex bits:		4.5, 5.5, 6.5		4, 5, 6			
		PH1, PH2		PZ1, PZ2			





Item ID: **T1419**



**SOCKET SET**

**1/4" DRIVE** **20 Pieces** **mm**

- Regular 6 point single hexagon sockets for a better grip
- Chrome vanadium satin finish sockets
- A selection of screwdriver and TX bits
- Supplied in the unique TengTools case with a snap lock
- Hard wearing hinge with a metal pin for longer life
- Designed and manufactured to DIN and ISO standards

1/4" Mini bits ratchet							
Magnetic bits holder, 1/4"M x 1/4" Hex adaptor							
Regular 6 point sockets:							
 mm:	5.5	6	7	8	9	10	13
1/4" Hex bits:		4, 5.5, 6.5		TX10, TX15, TX20			
		PH1, PH2		PZ1, PZ2			





Item ID: **T1420**



**SOCKET SET**

**1/4" DRIVE** **22 Pieces** **mm**

- Regular 6 point single hexagon sockets for a better grip
- Chrome vanadium satin finish sockets
- A selection of screwdriver and TX bits
- Supplied in the unique TengTools case with a snap lock
- Hard wearing hinge with a metal pin for longer life
- Designed and manufactured to DIN and ISO standards

72 Teeth ratchet							
Coupler adaptor, 2" Extension bar							
Regular 6 point sockets:							
 mm:	4	5	5.5	6	7	8	10 12 13
1/4" Hex bits:		4, 5.5, 6.5		TX10, TX15, TX20			
		PH1, PH2		PZ1, PZ2			

Item ID: **T1422**



**1/4" DRIVE** **23 Pieces** **mm**

### SOCKET SET

- Regular 6 point single hexagon sockets for a better grip
- Chrome vanadium satin finish sockets
- A 4" adjustable wrench and a selection of bits
- Supplied in the unique TengTools case with a snap lock
- Hard wearing hinge with a metal pin for longer life
- Designed and manufactured to DIN and ISO standards

1/4" Mini bits ratchet										
4" Adjustable wrench, 1/4"M x 1/4" Hex adaptor, 2" Extension bar										
Regular 6 point sockets:										
mm:	4	5	5.5	6	7	8	10	12	13	
1/4" Hex bits:	⊖	4, 5.5, 6.5		⊛	TX10, TX15, TX20					
	⊕	PH1, PH2		⊕	PZ1, PZ2					

Item ID: **T1423**



**1/4" DRIVE** **24 Pieces** **mm**

### SOCKET SET

- Regular 6 point single hexagon sockets for a better grip
- Chrome vanadium satin finish sockets
- A selection of screwdriver, hex and TX bits
- Supplied in the unique TengTools case with a snap lock
- Hard wearing hinge with a metal pin for longer life
- Designed and manufactured to DIN and ISO standards

72 Teeth flexible ratchet										
3" Extension bar, Universal Joint, Coupler adaptor										
Regular 6 point sockets:										
mm:	4	5	5.5	6	7	8	10	11	12	13
1/4" Hex bits:	⊖	4, 5.5		⊛	TX10, TX15, TX20					
	⊕	PH1, PH2		⊕	3, 5, 6					

Item ID: **T1424S**



**1/4" DRIVE** **24 Pieces** **mm**

### SOCKET SET

- Regular 6 point single hexagon sockets for a better grip
- Chrome vanadium satin finish sockets
- A selection of screwdriver, hex and TX bits
- Supplied in the unique TengTools case with a snap lock
- Hard wearing hinge with a metal pin for longer life
- Designed and manufactured to DIN and ISO standards

Flip reverse ratchet										
3" Extension bar, Universal Joint, Bits holder										
Regular 6 point sockets:										
mm:	4	5	5.5	6	7	8	10	11	12	13
1/4" Hex bits:	⊖	4, 5.5		⊛	TX10, TX15, TX20					
	⊕	PH1, PH2		⊕	3, 5, 6					

Item ID: **T1424**



**1/4" DRIVE** **35 Pieces** **AF**

### SOCKET SET

- Regular and deep 6 point single hexagon sockets for a better grip
- Chrome vanadium satin finish sockets
- A selection of screwdriver, hex and TX bits
- Supplied in the unique TengTools case with a snap lock
- Hard wearing hinge with a metal pin for longer life
- Designed and manufactured to DIN and ISO standards

Flip reverse ratchet, Universal Joint, Hex Keys: 1.5, 2 & 2.5mm										
Coupler adaptor, 2" & 4" Extension bars, 3/8"F x 1/4"M T-bar adaptor										
6 point sockets:										
Reg AF:	3/16	7/32	1/4	9/32	5/16	11/32	3/8	7/16	1/2	
Deep AF:	3/16	1/4	5/16	3/8	7/16	1/2				
1/4" Hex bits:	⊖	4, 5.5		⊛	TX10, TX15, TX20			⊕	5, 6	
	⊕	PH1, PH2		⊕	PZ1, PZ2					







Item ID: **T1435AF**



**SOCKET SET**

**1/4" DRIVE** **36 Pieces** **mm**

- Regular and deep 6 point single hexagon sockets for a better grip
- Chrome vanadium satin finish sockets
- A selection of screwdriver, hex and TX bits
- Supplied in the unique TengTools case with a snap lock
- Hard wearing hinge with a metal pin for longer life
- Designed and manufactured to DIN and ISO standards

Flip reverse ratchet, Universal Joint, Hex Keys: 1.5, 2 & 2.5mm											
Coupler adaptor, 2" & 4" Extension bars, 3/8" F x 1/4" M T-bar adaptor											
6 point sockets:											
	Reg mm:	4	5	5.5	6	7	8	10	11	12	13
	Deep mm:	6	7	8	10	12	13				
1/4" Hex bits:			4, 5.5		TX10, TX15, TX20				5, 6		
			PH1, PH2		PZ1, PZ2						

Item ID: **T1436**













Fully recyclable packaging to protect the environment.



**SOCKET SET**

**1/4" DRIVE** **60 Pieces** **mm AF**

- Regular and deep 6 point single hexagon sockets for a better grip
- Chrome vanadium satin finish sockets
- A selection of screwdriver, hex and TX bits
- Supplied in the unique TengTools carrying case
- Hard wearing case with distinctive branding
- Tools clearly laid out to easily identify which tool belongs where
- Designed and manufactured to DIN and ISO standards

Flip reverse ratchet, Universal Joint, Spinner handle											
Coupler adaptor, 2" & 4" Extension bars, 3/8" F x 1/4" M T-bar adaptor											
6 point sockets:											
	Reg mm:	4	4.5	5	5.5	6	7	8	9		
		10	11	12	13						
	Reg AF:	3/16	7/32	1/4	9/32	5/16	11/32	3/8	7/16	1/2	
	Deep mm:	6	7	8	10	12	13				
	Deep AF:	1/4	5/16	3/8	7/16	1/2					
1/4" drive bit sockets:											
	mm:	4	5.5	7							
	TX:	10	15	20	25	27					
	PH:	1	2								
1/4" Hex bits:			4, 5.5		5, 6						
			PH1, PH2		PZ1, PZ2						

Item ID: **T1460**







**1/4" DRIVE** 35 Pieces **mm**

### SOCKET SET

- Regular and deep 6 point single hexagon sockets
- Chrome vanadium satin finish sockets
- Designed and manufactured to DIN and ISO standards

72 Teeth ratchet, Universal Joint, 6" spinner handle										
Coupler adaptor, 2" & 4" Extension bars, 3/8"F x 1/4"M T-bar adaptor										
6 point sockets:										
Reg mm:	4	5	5.5	6	7	8	9			
	10	11	12	13						
Deep mm:	6	7	8	10	12	13				
1/4" Hex bits:	-		4, 5.5	TPX10, TPX15, TPX20			-		5, 6	
	+		PH1, PH2	+		PZ1, PZ2				

Item ID: **TT1435**

**NEW**



**1/4" DRIVE** 48 Pieces **mm**

### SOCKET SET

- Gearless palm ratchet, 3" extension bar
- 1/4" drive regular 6 point sockets 5–13mm
- A selection of 25mm & 89mm long bits

Gearless palm ratchet, 3" extension bar										
6 point sockets:										
Reg mm:	5	5.5	6	7	8	9	10	11		
	11	12	13							
1/4" Hex bits: Length 25mm	-		3.5, 5.5, 8	+			PZ1, PZ2, PZ3	-		2, 3, 4, 5, 6, 8
	+		PH1, PH2, PH3	+			TPX20, TPX25, TPX30	-		ROB1, 2, 3
	+		TX10, TX15, TX20, TX25, TX30, TX40							
1/4" Hex bits: Length 89mm	-		3, 4	+		PH1, PH2		+		PZ1, PZ2
	+		TX10, TX20, TX25							

Item ID: **TT1448**

**NEW**



**1/4" DRIVE** 35 Pieces **mm**

### SOCKET SET

- Regular and deep 12 point bi-hexagon sockets
- Chrome vanadium satin finish sockets
- Designed and manufactured to DIN and ISO standards

72 Teeth ratchet, Universal Joint, 6" spinner handle										
Coupler adaptor, 2" & 4" Extension bars, 3/8"F x 1/4"M T-bar adaptor										
12 point sockets:										
Reg mm:	4	5	5.5	6	7	8	9			
	10	11	12	13						
Deep mm:	6	7	8	10	12	13				
1/4" Hex bits:	-		4, 5.5	+			TPX10, TPX15, TPX20	-		5, 6
	+		PH1, PH2	+		PZ1, PZ2				

Item ID: **TT143512**

**NEW**



**1/4" DRIVE** 87 Pieces **mm AF**

### SOCKET SET

- Gearless palm ratchet, accessories and a bi-flex wrench
- 1/4" drive regular 6 point sockets in metric and AF
- 1/4" drive deep 6 point sockets
- A selection of 25mm long bits

Gearless palm ratchet, 3" extension bar, 1/4"Mx1/4"Hex adaptor, Bi Flex wrench										
6 point sockets:										
Reg mm:	5	5.5	6	7	8	9	10	11		
	11	12	13							
Reg AF:	1/4"	5/16"	3/8"							
Deep mm:	6	7	8	9	10	11	12	13		
1/4" Hex bits: Length 25mm	-		3.5, 4, 4.5, 5.5 (x2), 6.5, 8	+			PZ1 (x3), PZ2 (x6), PZ3			
	+		PH1 (x3), PH2 (x6), PH3	-		2, 3, 4, 5, 6, 8 mm				
	+		TX6, TX7, TX8, TX9, TX10, TX15, TX20(x3), TX25(x3), TX27, TX30, TX40							
	+		TPX10, TPX15, TPX20 (x2), TPX25 (x2), TPX27, TPX30, TPX40							
-		ROB1, 2, 3		+		PH2G				

Item ID: **TEA1487**



**1/4" DRIVE** **89 Pieces** **mm** **EVA**

**SOCKET SET**

- 1/4" drive regular and deep sockets
- A comprehensive range of 1/4" hex drive 25mm bits
- Supplied in the unique TengTools double width TC tray
- Tools are held in place using three colour pre-cut EVA foam clearly showing where each tool belongs
- Designed and manufactured to DIN and ISO standards

72 Teeth ratchet, Universal Joint, Spinner handle, 2" & 4" Extension bars										
Coupler adaptor, 3/8" F x 1/4" M T-bar adaptor, 1/4" M x 1/4" Hex adaptor										
6 point sockets:										
○ Reg mm:	4	5	5.5	6	7	8	9			
	10	11	12	13						
○ Deep mm:	4	5	5.5	6	7	8	9			
	10	12	13							
1/4" drive bit sockets:										
⊖ mm:	4	5.5	7							
⊛ TX:	10	15	20	25	27	30	40			
⊕ PZ:	1	2	3							
⊕ PH:	0	1	2	3						
1/4" Hex bits:	⊖	3, 4, 5.5, 7	⊛	TX8, TX10, TX15, TX20, TX25, TX27, TX30						
	⊕	TPX10, TPX15, TPX20, TPX25, TPX27, TPX30, TPX40								
	⊕	PZ0, PZ1, PZ2, PZ3	⊕	PH0, PH1, PH2, PH3, PH4						
	⊕	3, 4, 5, 6, 8, 10	⊕	1/8, 9/64, 5/32, 3/16, 1/4, 5/16						
	⊕	XZN: 5, 6								

Item ID: **TED1489**



**1/4" DRIVE** **12 Pieces** **mm**

**SOCKET SET**

- 6 point single hexagon socket for a better grip
- Chrome vanadium
- Satin finish for a better grip when handling the socket
- Ball bearing recess on the female end to grip the ratchet
- Supplied with a clip rail with socket clips for easy storage as a set
- Designed and manufactured to DIN3120/3124 and ISO2725

Clip rail (Length 185mm), 1/4" drive socket clips x12

Regular 6 point sockets:

○ mm:	4	4.5	5	5.5	6	7
	8	9	10	11	12	13

Item ID: **M1412**



**1/4" DRIVE** **9 Pieces** **mm**

**SOCKET SET**

- Long sockets for extra reach
- Chrome vanadium
- Satin finish for a better grip when handling the socket
- 6 point single hexagon socket for a better grip
- Ball bearing recess on the female end to grip the ratchet
- Supplied with a clip rail with socket clips for easy storage as a set
- Designed and manufactured to DIN3120/3124 and ISO2725

Clip rail (Length 165mm), 1/4" drive socket clips x9

Deep 6 point sockets:

○ mm:	4	5	6	7	8	9	10	12	13
-------	---	---	---	---	---	---	----	----	----

Item ID: **M1407**



**1/4" DRIVE** **7 Pieces**

**SOCKET SET**

- All the most commonly used sizes in one handy set
- Chrome vanadium
- S2 steel bits pressed in to the socket
- Satin finish for a better grip when handling the socket
- Designed for use with TX fastenings
- Supplied with a clip rail with socket clips for easy storage as a set

Clip rail (Length 110mm), 1/4" drive socket clips x7

TX bit sockets:

⊛ TX:	10	15	20	25	27	30	40
-------	----	----	----	----	----	----	----

Item ID: **M1408TX**



**3/8"**  
DRIVE



**3/8"**  
DRIVE **12** Pieces **mm**

### SOCKET SET

- A basic no nonsense set of 3/8" drive sockets
- Chrome vanadium
- 6 point single hexagon sockets for a better fit
- Ball bearing recess on the female end to grip the ratchet
- Designed and manufactured to DIN and ISO standards
- Supplied in a handy pocket sized holder with a clip rail facility for adding additional sockets or accessories

Flip Reverse Ratchet, 3" Extension Bar						
Regular 6 point sockets:						
mm:	8	10	11	12	13	14
	15	16	17	19		

Item ID: **M3812N1**



**3/8"**  
DRIVE **34** Pieces **mm**

### SOCKET SET

- Includes the TengTools stubby flex head ratchet
- Regular 6 point single hexagon sockets for a better grip
- Chrome vanadium satin finish sockets
- A selection of screwdriver, hex and TX bits
- Supplied in the unique TengTools case with a snap lock
- Designed and manufactured to DIN and ISO standards

72 Teeth flexible head ratchet, 3" & 6" Extension Bars									
Coupler adaptor, 1/2" F x 3/8" M T-bar adaptor									
Regular 6 point sockets:									
mm:	8	10	11	12	13	14	15	17	19
1/4" Hex bits:	-		3, 4, 5, 5	+		TX10, TX15, TX20, TX25, TX27, TX30, TX40			
	+		PH1, PH2, PH3	+		PZ1, PZ2, PZ3	3, 4, 5, 6		

Item ID: **T38345**



**3/8"**  
DRIVE **34** Pieces **mm**

### SOCKET SET

- Regular 6 point single hexagon sockets for a better grip
- Chrome vanadium satin finish sockets
- A selection of screwdriver, hex and TX bits
- Supplied in the unique TengTools case with a snap lock
- Hard wearing hinge with a metal pin for longer life
- Designed and manufactured to DIN and ISO standards

Flip Reverse Ratchet, 3" & 6" Extension Bars									
Coupler adaptor, 1/2" F x 3/8" M T-bar adaptor									
Regular 6 point sockets:									
mm:	8	10	11	12	13	14	15	17	19
	1/4" Hex bits:	-		3, 4, 5, 5	+		TX10, TX15, TX20, TX25, TX27, TX30, TX40		
+		PH1, PH2, PH3	+		PZ1, PZ2, PZ3	3, 4, 5, 6			

Item ID: **T3834**



**3/8"**  
DRIVE **35** Pieces **AF**

### SOCKET SET

- Regular and deep 6 point single hexagon sockets for a better grip
- Chrome vanadium satin finish sockets
- A selection of screwdriver, hex and TX bits
- Hard wearing case with distinctive branding
- Tools clearly laid out to easily identify which tool belongs where
- Designed and manufactured to DIN and ISO standards

Flip reverse ratchet, Universal joint, 4" & 6" Extension Bars										
Coupler adaptor, 1/2" F x 3/8" M T-bar adaptor										
6 point sockets:										
Reg AF:	5/16	3/8	7/16	1/2	9/16	5/8	11/16	3/4	13/16	7/8
Deep AF:	3/8	7/16	1/2	9/16	11/16	3/4				
Spark Plug Sockets mm:	16	21								
1/4" Hex bits:	-		4, 5, 5	+		TX10, TX15, TX20	+		5, 6	
	+		PH1, PH2	+		PZ1, PZ2				

Item ID: **T3835AF**



**3/8"**  
DRIVE **39**  
Pieces **mm**

**SOCKET SET**

- Regular and deep 6 point single hexagon sockets for a better grip
- Chrome vanadium satin finish sockets
- A selection of screwdriver, hex and TX bits
- Hard wearing case with distinctive branding
- Tools clearly laid out to easily identify which tool belongs where
- Designed and manufactured to DIN and ISO standards

Flip reverse ratchet, Universal joint, 3" Wobble extension bar, 6" Extension Bar																						
Coupler adaptor, 1/2"F x 3/8"M T-bar adaptor																						
6 point sockets:																						
○ Reg mm:	8	9	10	11	12	13	14	15	16	17												
	18	19	21	22																		
○ Deep mm:	8	10	12	13	17	19																
Spark Plug Sockets mm:																						
16 21																						
1/4" Hex bits:																						
<table border="0" style="width:100%; text-align:center;"> <tr> <td>⊖</td><td>4, 5, 5</td><td>⊕</td><td>TX10, TX15, TX20</td><td>⊙</td><td>5, 6</td> </tr> <tr> <td>⊕</td><td>PH1, PH2</td><td>⊕</td><td>PZ1, PZ2</td><td></td><td></td> </tr> </table>											⊖	4, 5, 5	⊕	TX10, TX15, TX20	⊙	5, 6	⊕	PH1, PH2	⊕	PZ1, PZ2		
⊖	4, 5, 5	⊕	TX10, TX15, TX20	⊙	5, 6																	
⊕	PH1, PH2	⊕	PZ1, PZ2																			

Item ID: **T3839**



**3/8"**  
DRIVE **39**  
Pieces **mm**

**SOCKET SET**

- Regular and 6 point single hexagon sockets for a better grip
- Combination spanners
- Chrome vanadium satin finish sockets and spanners
- A selection of screwdriver, hex and TX bits
- Hard wearing case with distinctive branding
- Tools clearly laid out to easily identify which tool belongs where
- Designed and manufactured to DIN and ISO standards

Flip reverse ratchet, Universal joint, 6" Extension Bar																						
Coupler adaptor, 1/2"F x 3/8"M T-bar adaptor																						
Regular 6 point sockets:																						
○ mm:	8	9	10	11	12	13	14	15	16	17												
	18	19	21	22																		
Combination Spanners:																						
8, 10, 11, 12, 13, 14, 15, 17, 19 mm																						
1/4" Hex bits:																						
<table border="0" style="width:100%; text-align:center;"> <tr> <td>⊖</td><td>4, 5, 5</td><td>⊕</td><td>TX10, TX15, TX20</td><td>⊙</td><td>5, 6</td> </tr> <tr> <td>⊕</td><td>PH1, PH2</td><td>⊕</td><td>PZ1, PZ2</td><td></td><td></td> </tr> </table>											⊖	4, 5, 5	⊕	TX10, TX15, TX20	⊙	5, 6	⊕	PH1, PH2	⊕	PZ1, PZ2		
⊖	4, 5, 5	⊕	TX10, TX15, TX20	⊙	5, 6																	
⊕	PH1, PH2	⊕	PZ1, PZ2																			

Item ID: **T3840**







## SOCKET & TOOL SET

3/8" DRIVE 48 Pieces mm AF

- Regular 6 point single hexagon sockets for a better grip
- A range of combination spanners together with an adjustable wrench, power grip plier, pliers and screwdrivers
- Chrome vanadium satin finish sockets and spanners
- Hard wearing case with distinctive branding
- Tools clearly laid out to easily identify which tool belongs where
- Designed and manufactured to DIN and ISO standards

Flip reverse ratchet, Universal Joint, 3" & 6" Extension bars									
Coupler adaptor, 1/2"F x 3/8"M T-bar adaptor									
Regular 6 point sockets:									
mm:	8	10	12	13	14	15	16	17	18
	19	21							
AF:	7/16	1/2	9/16	11/16					
Spark Plug Sockets mm:									
	16	21							
Combination Spanners:									
	8, 10, 12, 13, 14, 15, 16, 17, 18, 19 mm								
	7/16", 1/2", 9/16", 11/16"								
Screwdrivers:									
	3	5.5	6.5	PH0	PH1	PH2			
Pliers:									
	6" Side Cutters, 7" Combination, 8" Long Nose, 10" Water Pump								
Power Grip Pliers:									
	7" Curved jaw								
Adjustable Wrench:									
	8" Phosphate Finish								

Item ID: T3848



## SOCKET & TOOL SET

3/8" DRIVE 67 Pieces mm

- Regular 6 point single hexagon sockets for a better grip
- A range of combination spanners, pliers and screwdrivers
- Chrome vanadium satin finish sockets and spanners
- A selection of screwdriver, hex and TX bits
- Hard wearing case with distinctive branding
- Tools clearly laid out to easily identify which tool belongs where
- Designed and manufactured to DIN and ISO standards

Flip reverse ratchet, 3" & 6" Extension bars, Bits driver, Magnetic bits holder									
Coupler adaptor, 1/2"F x 3/8"M T-bar adaptor									
Regular 6 point sockets:									
mm:	8	9	10	11	12	13	14	15	16
	17	18	19	20	22				
Combination Spanners:									
	8, 10, 11, 12, 13, 14, 15, 16, 17, 19 mm								
Screwdrivers:									
	3	5.5	6.5	PH0	PH1	PH2			
Pliers:									
	6" Side Cutters, 7" Combination, 8" Long Nose, 10" Water Pump								
1/4" Hex bits:									
	TX8, TX10, TX15, TX20, TX25, TX27, TX30, TX40, TX45, TX50								
	3, 4, 5, 6, 8, 10								
	4, 5.5, 7								

Item ID: T3867



Secure lock system with click mechanism so you know the top is closed properly



**SOCKET & TOOL SET**

**3/8"**  
DRIVE **79**  
PIECES **mm**

- Regular 6 point single hexagon sockets for a better grip
- Combination spanners, adjustable wrench, a hex key set, LED light, utility knife, hook and pick set, measuring tape, gun saw, claw hammer, magnetic pick up, pliers and screwdrivers
- Chrome vanadium satin finish sockets and spanners
- Hard wearing case with distinctive branding
- Tools clearly laid out to easily identify which tool belongs where
- Designed and manufactured to DIN and ISO standards

Flip reverse ratchet, 5" Extension bar, Universal Joint, Bits driver, Magnetic bits holder									
Coupler adaptor, 1/2"F x 3/8"M T-bar adaptor									
Regular 6 point sockets:									
mm:	8	10	11	12	13	14	15	17	19
	20	21	22						
LED Light with clip, 5m Measuring tape, Utility knife, Telescopic magnet, Gun saw, Hook & pick set, 16oz claw hammer, Folding hex key set, 8" wide jaw adjustable wrench									
Combination Spanners:	6, 7, 8, 10, 11 mm								
Screwdrivers:	⊖	3	5.5	6.5	⊕	PH1	PH2		
Pliers:	6" Side Cutters, 7" Combination, 8" Long Nose, 10" Water Pump								
1/4" Hex bits:	⊕	TX10, TX15, TX20, TX25, TX27, TX30, TX40	⊖	4.5, 5.5, 6.5					
	⊕	TPX20, TPX25, TPX30	⊕	PH1, PH2, PH3, PH2G (x2)					
	⊕	4, 5, 6	⊕	PZ1, PZ2, PZ3					

Item ID: **TM079**



**SOCKET & TOOL SET**

**3/8"**  
DRIVE **79**  
PIECES **mm**

- Regular 6 point single hexagon sockets for a better grip
- Combination spanners, adjustable wrench, a hex key set, LED light, utility knife, hook and pick set, measuring tape, gun saw, engineers hammer, magnetic pick up, pliers and screwdrivers
- Chrome vanadium satin finish sockets and spanners
- Hard wearing case with distinctive branding
- Tools clearly laid out to easily identify which tool belongs where
- Designed and manufactured to DIN and ISO standards

Flip reverse ratchet, 5" Extension bar, Universal Joint, Bits driver, Magnetic bits holder									
Coupler adaptor, 1/2"F x 3/8"M T-bar adaptor									
Regular 6 point sockets:									
mm:	8	10	11	12	13	14	15	17	19
	20	21	22						
LED Light with clip, 5m Measuring tape, Utility knife, Telescopic magnet, Gun saw, Hook & pick set, 500g Engineers hammer, Folding hex key set, 8" wide jaw adjustable wrench									
Combination Spanners:	6, 7, 8, 10, 11 mm								
Screwdrivers:	⊖	3	5.5	6.5	⊕	PH1	PH2		
Pliers:	6" Side Cutters, 7" Combination, 8" Long Nose, 10" Water Pump								
1/4" Hex bits:	⊕	TX10, TX15, TX20, TX25, TX27, TX30, TX40	⊖	4.5, 5.5, 6.5					
	⊕	TPX20, TPX25, TPX30	⊕	PH1, PH2, PH3, PH2G (x2)					
	⊕	4, 5, 6	⊕	PZ1, PZ2, PZ3					

Item ID: **TM079E**



You can rest assured that your tools are protected in a fully organised Teng Tools carry case. Made from fully recyclable plastic material with hard-wearing metal pin hinges these cases are built to last.



# Socket Sets 3/8" DRIVE



**3/8" DRIVE** **19 Pieces** **mm**

## SOCKET SET

- Regular 6 point single hexagon sockets
- Chrome vanadium satin finish sockets
- Designed and manufactured to DIN and ISO standards

72 Teeth ratchet, Universal Joint, 3" Wobble extension bar, 10" Spinner handle

Coupler adaptor, 1/2" F x 3/8" M T-bar adaptor

Regular 6 point sockets:

mm:	8	9	10	11	12	13	14	15	16
	17	18	19	22					

Item ID: TT3819

**NEW**



**3/8" DRIVE** **19 Pieces** **mm**

## SOCKET SET

- Regular 12 point bi-hexagon sockets
- Chrome vanadium satin finish sockets
- Designed and manufactured to DIN and ISO standards

72 Teeth ratchet, Universal Joint, 3" Wobble extension bar, 10" Spinner handle

Coupler adaptor, 1/2" F x 3/8" M T-bar adaptor

Regular 12 point sockets:

mm:	8	9	10	11	12	13	14	15	16
	17	18	19	22					

Item ID: TT381912



**1/4" DRIVE** **3/8" DRIVE** **32 Pieces** **AF**

## SOCKET SET

- Regular and deep 6 point single hexagon sockets
- Chrome vanadium satin finish sockets
- Designed and manufactured to DIN3120/3124 and ISO2725

3/8" Drive 6 point sockets:

Reg AF:	3/8	7/16	1/2	9/16	5/8	11/16	3/4		
Deep AF:	3/8	7/16	1/2	9/16	5/8	11/16	3/4		

1/4" Drive 6 point sockets:

Reg AF:	3/16	7/32	1/4	9/32	5/16	11/32	3/8	7/16	1/2
Deep AF:	3/16	7/32	1/4	9/32	5/16	11/32	3/8	7/16	1/2

Item ID: TTAF32

**NEW**



**1/4" DRIVE** **3/8" DRIVE** **32 Pieces** **AF**

## SOCKET SET

- Regular and deep 12 point bi-hexagon sockets
- Chrome vanadium satin finish sockets
- Designed and manufactured to DIN3120/3124 and ISO2725

3/8" Drive 12 point sockets:

Reg AF:	3/8	7/16	1/2	9/16	5/8	11/16	3/4		
Deep AF:	3/8	7/16	1/2	9/16	5/8	11/16	3/4		

1/4" Drive 12 point sockets:

Reg AF:	3/16	7/32	1/4	9/32	5/16	11/32	3/8	7/16	1/2
Deep AF:	3/16	7/32	1/4	9/32	5/16	11/32	3/8	7/16	1/2

Item ID: TTAF3212



**3/8"**  
DRIVE **16**  
PIECES **mm**

**SOCKET SET**

- Deep 3/8" drive 6 point single hexagon sockets
- Chrome vanadium satin finish sockets
- Designed and manufactured to DIN3120/3124 and ISO2725

Deep 6 point sockets:

mm:	7	8	9	10	11	12	13	14	15
	16	17	18	19	20	21	22		

Item ID: **TT3816**

**NEW**



**3/8"**  
DRIVE **16**  
PIECES **mm**

**SOCKET SET**

- Deep 3/8" drive 12 point bi-hexagon sockets
- Chrome vanadium satin finish sockets
- Designed and manufactured to DIN3120/3124 and ISO2725

Deep 12 point sockets:

mm:	7	8	9	10	11	12	13	14	15
	16	17	18	19	20	21	22		

Item ID: **TT381612**



**1/4"**  
DRIVE **3/8"**  
DRIVE **30**  
PIECES

**BIT SOCKET SET**

- Chrome vanadium satin finish sockets
- Designed and manufactured to DIN and ISO standards

3" Extension bar, 3/8"F x 1/4"M adaptor

3/8" Drive bit sockets:

	TX:	10	15	20	25	27	30	40	45	50
	TPX:	10	15	20	25	27	30	40	45	50
	TX-E:	E10	E12	E14	E16	E18				

1/4" Drive bit sockets:

	TX-E:	E4	E5	E6	E7	E8				
--	-------	----	----	----	----	----	--	--	--	--

Item ID: **TTTX30**



**1/4"**  
DRIVE **3/8"**  
DRIVE **35**  
PIECES

**BIT SOCKET SET**

- Includes all the most commonly used screwdriver, hex and TX bits
- Chrome vanadium satin finish sockets

3/8"F x 1/4"M adaptor, 1/4"F x 3/8"M adaptor

3/8" Drive bit sockets:

	mm:	3	4	5	5.5	6	7	8	10	12
	AF:	1/8	5/32	3/16	7/32	1/4	5/16	3/8		

1/4" Drive bit sockets:

	TX:	10	15	20	25	27	30	40		
	mm:	4	4.5	7						
	PH:	0	1	2	3					
	PZ:	1	2	3						

Item ID: **TTBS35**





### SOCKET SET

- 3/8" drive regular length sockets
- A range of 3/8" drive socket bits covering hex and TX sizes
- Tools are held in place using three colour pre-cut EVA foam clearly showing where each tool belongs
- Designed and manufactured to DIN and ISO standards



72 Teeth ratchet, Universal Joint, 3" Wobble extension bar,									
1/2"F x 3/8"M T-bar adaptor, 10" Spinner handle									
Regular 6 point sockets:									
mm:	8	9	10	11	12	13	14	15	16
	17	18	19	22					
3/8" Drive bit sockets:									
TX:	10	15	20	25	27	30	40	45	50
mm:	3	4	5	5.5	6	7	8	10	12

Item ID: TED3836



### SOCKET SET

- 6 point single hexagon socket for a better grip
- Chrome vanadium
- Satin finish for a better grip when handling the socket
- Ball bearing recess on the female end to grip the ratchet
- Supplied with a clip rail with socket clips for easy storage as a set
- Designed and manufactured to DIN3120/3124 and ISO2725



Clip rail (Length: 370mm), 3/8" Drive socket clips x16									
Regular 6 point sockets:									
mm:	7	8	9	10	11	12	13	14	15
	16	17	18	19	20	21	22		

Item ID: M3816



### SOCKET SET

- Long sockets for extra reach
- Chrome vanadium
- Satin finish for a better grip when handling the socket
- 6 point single hexagon socket for a better grip
- Ball bearing recess on the female end to grip the ratchet
- Supplied with a clip rail with socket clips for easy storage as a set
- Designed and manufactured to DIN3120/3124 and ISO2725

Clip rail (Length: 165mm), 3/8" Drive socket clips x7									
Deep 6 point sockets:									
mm:	10	12	13	14	15	17	19		

Item ID: M3807



### SOCKET SET

- 4430 stainless steel making it ideal for the food, medical, aerospace and marine industries or for use in any acidic environment
- 6 point single hexagon sockets for a better grip
- Satin finish for a better grip when handling the socket
- Ball bearing recess on the female end to grip the ratchet
- Supplied with a clip rail with socket clips for easy storage as a set
- Designed and manufactured to DIN3120/3124 and ISO2725

Clip rail, 3/8" Drive socket clips x14, 3" & 5" Extension bars									
Regular stainless steel 6 point sockets:									
mm:	8	9	10	11	12	13	14	15	16
	17	18	19						

Item ID: MS3814



**HEX BIT SOCKET SET**

**3/8" DRIVE** **9 Pieces** **mm**

- Chrome vanadium
- S2 steel bits pressed in to the socket
- Satin finish for a better grip when handling the socket
- Designed for use with fastenings with a hexagon hole
- Use with in-hex screws or grub screws
- Designed and manufactured to DIN7422
- Supplied with a clip rail with socket clips for easy storage as a set

Clip rail (Length: 165mm), 3/8" Drive socket clips x9										
3/8" Drive bit sockets:										
	mm:	3	4	5	5.5	6	7	8	10	12

Item ID: **M3812**



**HEX BIT SOCKET SET**

**3/8" DRIVE** **8 Pieces** **AF**

- Chrome vanadium
- S2 steel bits pressed in to the socket
- Satin finish for a better grip when handling the socket
- Designed for use with fastenings with a hexagon hole
- Use with in-hex screws or grub screws
- Supplied with a clip rail with socket clips for easy storage as a set

Clip rail (Length: 165mm), 3/8" Drive socket clips x8										
3/8" Drive bit sockets:										
	AF:	3/32	1/8	5/32	3/16	7/32	1/4	5/16	3/8	

Item ID: **M3811**



**TPX BIT SOCKET SET**

**3/8" DRIVE** **9 Pieces**

- Chrome vanadium
- S2 steel bits pressed in to the socket
- Satin finish for a better grip when handling the socket
- Designed for use with tamper proof TX fastenings
- Supplied with a clip rail with socket clips for easy storage as a set

Clip rail (Length: 165mm), 3/8" Drive socket clips x9										
3/8" Drive bit sockets:										
	TPX:	10	15	20	25	27	30	40	45	50

Item ID: **M3813TPX**



**TX BIT SOCKET SET**

**3/8" DRIVE** **9 Pieces**

- Chrome vanadium
- S2 steel bits pressed in to the socket
- Satin finish for a better grip when handling the socket
- Designed for use with TX fastenings
- Supplied with a clip rail with socket clips for easy storage as a set

Clip rail (Length: 165mm), 3/8" Drive socket clips x9										
3/8" Drive bit sockets:										
	TX:	10	15	20	25	27	30	40	45	50



Item ID: **M3813TX**



**TX-E BIT SOCKET SET**

**1/4" DRIVE** **3/8" DRIVE** **10 Pieces**

- TX-E Clip rail set
- Chrome vanadium
- Ball bearing recess on the female end to grip the ratchet
- Designed for use with protruding TX head screws
- Supplied with a clip rail with socket clips for easy storage as a set

Clip rail (Length: 165mm), 3/8" Drive socket clips x5, 1/4" Drive socket clips x5										
3/8" Drive bit sockets:										
	TX-E:	E10	E12	E14	E16	E18				
1/4" Drive bit sockets:										
	TX-E:	E4	E5	E6	E7	E8				

Item ID: **M3814**



**CROW FOOT WRENCH SET**

**3/8" DRIVE** **8 Pieces** **mm**

- Open ended spanner at right angle to square drive
- Ideal for accessing confined spaces
- Use with a ratchet or torque wrench with an extension bar
- Satin finish chrome vanadium
- Supplied with a clip rail with socket clips for easy storage

3/8" Drive Crow Foot Wrenches										
10, 11, 12, 13, 16, 17, 18, 19 mm										

Item ID: **M3808MM**



1/2" DRIVE



1/2" DRIVE 12 Pieces mm

### SOCKET SET

- 12 point bi-hexagon sockets for easier alignment to the fastening
- Chrome vanadium
- Satin finish for a better grip when handling the socket
- Ball bearing recess on the female end to grip the ratchet
- Designed and manufactured to DIN and ISO standards
- Supplied in a handy pocket sized holder with a clip rail facility for adding additional sockets or accessories

Flip Reverse Ratchet, 5" Extension Bar						
Regular 12 point sockets:						
mm:	8	10	12	13	14	15
	17	18	19	24		

Item ID: M1212N1



1/2" DRIVE 20 Pieces AF

### SOCKET SET

- 12 point bi-hexagon sockets for easier alignment to the fastening
- Chrome vanadium satin finish sockets
- Hard wearing case with distinctive branding
- Tools clearly laid out to easily identify which tool belongs where
- Designed and manufactured to DIN and ISO standards

Flip reverse ratchet, 2 1/2" & 6" Extension bars									
Universal joint, 3/8" F x 1/2" M T-bar adaptor									
Regular 12 point sockets:									
AF:	3/8	7/16	1/2	9/16	5/8	11/16	3/4	13/16	7/8
	15/16	1	1-1/16	1-1/8	1-3/16	1-1/4			

Item ID: T1220AF



1/2" DRIVE 21 Pieces mm

### SOCKET SET

- 12 point bi-hexagon sockets for easier alignment to the fastening
- Chrome vanadium satin finish sockets
- Hard wearing case with distinctive branding
- Tools clearly laid out to easily identify which tool belongs where
- Designed and manufactured to DIN and ISO standards

Flip reverse ratchet, 2 1/2" & 6" Extension bars									
Universal joint, 3/8" F x 1/2" M T-bar adaptor									
Regular 12 point sockets:									
mm:	10	11	12	13	14	15	16	17	18
	19	21	22	24	27	30	32		

Item ID: T1221



1/2" DRIVE 21 Pieces mm

### SOCKET SET

- 6 point single hexagon sockets for a better grip
- Chrome vanadium satin finish sockets
- Hard wearing case with distinctive branding
- Tools clearly laid out to easily identify which tool belongs where
- Designed and manufactured to DIN and ISO standards

Flip reverse ratchet, 2 1/2" & 6" Extension bars									
Universal joint, 3/8" F x 1/2" M T-bar adaptor									
Regular 6 point sockets:									
mm:	10	11	12	13	14	15	16	17	18
	19	21	22	24	27	30	32		



Item ID: T1221-6



**SOCKET SET**

**1/2" DRIVE** **30 Pieces** **mm** **AF**

- 12 point bi-hexagon sockets for easier alignment to the fastening
- Chrome vanadium satin finish sockets
- Hard wearing case with distinctive branding
- Tools clearly laid out to easily identify which tool belongs where
- Designed and manufactured to DIN and ISO standards

Flip reverse ratchet, 5" Extension bar										
Universal joint, 3/8" F x 1/2" M T-bar adaptor										
Regular 12 point sockets:										
	AF:	3/8	7/16	1/2	9/16	5/8	3/4	13/16	15/16	1
		1-1/8	1-1/4							
	mm:	10	12	13	14	15	16	17	18	19
		21	22	24	27	30	32			



Item ID: **T1230**



**SOCKET SET**

**1/2" DRIVE** **34 Pieces** **mm**

- 6 point single hexagon sockets for a better grip
- Chrome vanadium satin finish sockets
- Hard wearing case with distinctive branding
- Tools clearly laid out to easily identify which tool belongs where
- Designed and manufactured to DIN and ISO standards

Flip reverse ratchet, 5" & 10" Extension bars										
Universal joint, 3/8" F x 1/2" M T-bar adaptor, Hex keys: 1.5, 2, 2.5mm										
6 point sockets:										
	Reg mm:	10	11	12	13	14	15	16	17	18
		19	20	21	22	23	24	27		
	Deep mm:	13	14	15	16	17	18	19	24	
Spark plug sockets mm:		16	21							





Item ID: **T1234**



**MECHANICS SOCKET SET**

**1/2" DRIVE** **44 Pieces** **mm** **AF**

- Regular and deep 12 point bi-hexagon sockets for easier alignment to the fastening
- Chrome vanadium satin finish sockets
- 10x13mm "Rigger Jigger" double ring spanner and screwdrivers
- Hard wearing case with distinctive branding
- Tools clearly laid out to easily identify which tool belongs where
- Designed and manufactured to DIN and ISO standards

Flip reverse ratchet, 17" Flex handle, 2 1/2", 5" & 10" Extension bars										
Universal joint, 3/8" F x 1/2" M T-bar adaptor										
Regular 12 point sockets:										
	AF:	3/8	1/2	9/16	19/32	11/16	25/32	13/16	1	
	mm:	10	11	12	13	14	15	16	17	18
		19	20	21	22	23	24	27	30	32
Deep 12 point sockets:										
	mm:	10	13	17	19					
Spark plug sockets mm:		16	21							
Screwdrivers:			5.5	6.5		PZ1	PZ2			
Double ring spanner:		10 x 13mm (Rigger Jigger)								

Item ID: **T1244**





### SOCKET & TOOL SET

1/2" DRIVE 68 Pieces mm

- 12 point bi-hexagon sockets for easier alignment to the fastening
- A range of combination spanners, pliers and screwdrivers
- Chrome vanadium satin finish sockets and spanners
- Hard wearing case with distinctive branding
- Tools clearly laid out to easily identify which tool belongs where
- Designed and manufactured to DIN and ISO standards

Flip reverse ratchet, 2 1/2" & 6" Extension bars, Bits driver, Magnetic bits holder	
Universal joint, 3/8" F x 1/2" M T-bar adaptor	
Regular 12 point sockets:	
mm:	10 11 12 13 14 15 16 17 18
	19 21 22 27 30 32
Combination spanners:	8, 10, 11, 12, 13, 14, 15, 16, 17, 19 mm
Screwdrivers:	3 5.5 6.5 PH0 PH1 PH2
Pliers:	6" Side cutter, 7" Combination, 8" Long nose, 10" Water pump
1/4" Hex bits:	TX8, TX10, TX15, TX20, TX25, TX27, TX30, TX40, TX45, TX50
	3, 4, 5, 6, 8, 10 4, 5.5, 7 PZ1, PZ2, PZ3
	PH0, PH1, PH2, PH3

Item ID: T1268



### RATCHET & ACCESSORIES SET

1/2" DRIVE 5 Pieces mm

- Socket accessory set
- Designed and manufactured to DIN and ISO standards

72 Teeth ratchet, 5" & 10" Extension bars
Universal joint, 3/8" F x 1/2" M T-bar adaptor

Item ID: TT1205



### SOCKET SET

1/2" DRIVE 11 Pieces mm

- 12 point bi-hexagon sockets
- Includes a 10" flex handle with ergonomic grip
- Chrome vanadium satin finish
- Designed and manufactured to DIN and ISO standards

10" Flex handle	
Deep 12 point sockets:	
mm:	10 11 12 13 14 15
	16 17 18 19

Item ID: TT1211



### SOCKET SET

1/2" DRIVE 17 Pieces mm

- 12 point bi-hexagon sockets
- Chrome vanadium satin finish sockets
- Designed and manufactured to DIN3120/3124 and ISO2725

Regular 12 point sockets:	
mm:	10 11 12 13 14 15 16 17 18
	19 20 21 22 24 27 30 32

Item ID: TT1217



### SOCKET SET

1/2" DRIVE 17 Pieces mm

- 6 point single hexagon sockets
- Chrome vanadium satin finish sockets
- Designed and manufactured to DIN3120/3124 and ISO2725

Regular 6 point sockets:	
mm:	10 11 12 13 14 15 16 17 18
	19 20 21 22 24 27 30 32

Item ID: TT1217-6



**1/2" DRIVE** **15 Pieces** **AF**

**SOCKET SET**

- 12 point bi-hexagon sockets
- Chrome vanadium satin finish sockets
- Designed and manufactured to DIN3120/3124 and ISO2725

Regular 12 point sockets:											
	AF:	3/8	7/16	1/2	9/16	5/8	11/16	3/4	13/16	7/8	
		15/16	1	1-1/16	1-1/8	1-3/16	1-1/4				

Item ID: **TT1215AF**



**1/2" DRIVE** **17 Pieces** **mm**

**SOCKET SET**

- 12 point bi-hexagon sockets
- Chrome vanadium satin finish sockets
- Designed and manufactured to DIN and ISO standards

72 Teeth ratchet, 2 1/2" & 10" Extension bars										
Universal joint, 3/8"F x 1/2"M T-bar adaptor										
Regular 12 point sockets:										
	mm:	10	11	12	13	14	15	16	17	18
		19	22	24						

Item ID: **TT1218**



**1/2" DRIVE** **17 Pieces** **mm**

**SOCKET SET**

- 6 point single hexagon sockets
- Chrome vanadium satin finish sockets
- Designed and manufactured to DIN and ISO standards

72 Teeth ratchet, 2 1/2" & 10" Extension bars										
Universal joint, 3/8"F x 1/2"M T-bar adaptor										
Regular 6 point sockets:										
	mm:	10	11	12	13	14	15	16	17	18
		19	22	24						

Item ID: **TT1218-6**



**1/2" DRIVE** **16 Pieces** **mm**

**HEX BIT SOCKET SET**

- Chrome vanadium satin finish sockets
- Designed and manufactured to DIN7422

 Hex bit sockets mm:										
Length 55mm:	5	6	7	8	9	10	12	14	17	
Length 100mm:	5	6	10	12	14	17				
Length 115mm:	8									

Item ID: **TTHex16**



**1/2" DRIVE** **23 Pieces** **mm**

### HEX BIT SOCKET SET

- Chrome vanadium satin finish bit holders included
- Grub screws to retain the bit in place, especially useful when working in difficult to reach places
- Designed and manufactured to DIN ISO 1173:2009-06

10mm Hex bit adaptor, 12mm Hex bit adaptor, 2mm Hex mini screwdriver							
Hex bit sockets mm:							
Length 40mm:	10mm Hex Drive:	5	6	7	8	9	10
	12mm Hex Drive:	12	14	17	19		
Length 115mm:	10mm Hex Drive:	5	6	7	8	9	10
	12mm Hex Drive:	12	14	17	19		

Item ID: **TTHEX23**



**1/2" DRIVE** **23 Pieces**

### TX BIT SOCKET SET

- Chrome vanadium satin finish bit holders included
- Grub screws to retain the bit in place, especially useful when working in difficult to reach places
- Designed and manufactured to DIN ISO 1173:2009-06

10mm Hex bit adaptor, 12mm Hex bit adaptor, 2mm Hex mini screwdriver										
TX bit sockets:										
Length 40mm:	10mm Hex Drive:	20	25	27	30	40	45	50	55	
	12mm Hex Drive:	60	70							
Length 75mm:	10mm Hex Drive:	20	25	27	30	40	45	50	55	
	12mm Hex Drive:	60	70							

Item ID: **TTTX23**



**1/2" DRIVE** **18 Pieces**

### TX BIT SOCKET SET

- Chrome vanadium satin finish sockets
- Designed and manufactured to DIN and ISO standards

TX bit sockets:										
Length 55mm:	20	25	27	30	40	45	50	55	60	
Length 110mm:	20	25	27	30	40	45	50	55	60	

Item ID: **TTTX18**



**1/2" DRIVE** **15 Pieces**

### HEX & TX BIT SOCKET SET

- 100mm length for easier access in recesses
- Chrome vanadium satin finish sockets
- Designed and manufactured to DIN and ISO standards

TX bit sockets:										
Length 100mm:	20	25	27	30	40	45	50	55	60	
Hex bit sockets mm:										
Length 100mm:	5	6	7	8	10	12				



Item ID: **TTTXH15**



**RIBE & XZN BIT SOCKET SET**

1/2" DRIVE 15 Pieces

- 100mm length for easier access in recesses
- Chrome vanadium satin finish sockets
- Designed and manufactured to DIN and ISO standards

 Ribe bit sockets:								
Length 100mm:	4	5	6	8	10	11	12	13
 XZN bit sockets:								
Length 100mm:	5	6	8	10	12	14	16	



Item ID: TTRS15



**SOCKET SET**

1/2" DRIVE 27 Pieces mm EVA

- 1/2" drive regular and deep sockets
- Supplied in the unique TengTools double width TC tray
- Tools are held in place using three colour pre-cut EVA foam clearly showing where each tool belongs
- Designed and manufactured to DIN and ISO standards

72 Teeth ratchet, 2 1/2" & 6" Extension bars									
Universal joint, 3/8" F x 1/2" M T-bar adaptor									
12 point sockets:									
 Reg mm:	10	11	12	13	14	15	16	17	18
	19	22	24						
 Deep mm:	10	11	12	13	14	15	16	17	18
	19								

Item ID: TED1227



1/2" DRIVE 15 Pieces mm

**SOCKET SET**

- 12 point bi-hexagon socket for easier alignment to the fastening
- Chrome vanadium
- Satin finish for a better grip when handling the socket
- Ball bearing recess on the female end to grip the ratchet
- Supplied with a clip rail with socket clips for easy storage as a set
- Designed and manufactured to DIN3120/3124 and ISO2725

Clip rail (Length: 430mm), 1/2" Drive socket clips x15									
Regular 12 point sockets:									
 mm:	10	12	13	14	15	16	17	18	19
	21	22	24	27	30	32			

Item ID: M1215MM



1/2" DRIVE 8 Pieces mm

**SOCKET SET**

- Long sockets for extra reach
- Chrome vanadium
- Satin finish for a better grip when handling the socket
- 12 point bi-hexagon socket for easier alignment to the fastening
- Ball bearing recess on the female end to grip the ratchet
- Supplied with a clip rail with socket clips for easy storage as a set
- Designed and manufactured to DIN3120/3124 and ISO2725

Clip rail (Length: 210mm), 1/2" Drive socket clips x8									
Deep 12 point sockets:									
 mm:	13	14	15	17	19	21	22	24	

Item ID: M1207



1/2" DRIVE 15 Pieces AF

**SOCKET SET**

- 12 point bi-hexagon socket for easier alignment to the fastening
- Chrome vanadium
- Satin finish for a better grip when handling the socket
- Ball bearing recess on the female end to grip the ratchet
- Supplied with a clip rail with socket clips for easy storage as a set
- Designed and manufactured to DIN3120/3124 and ISO2725

Clip rail (Length: 430mm), 1/2" Drive socket clips x15									
Regular 12 point sockets:									
 AF:	3/8	7/16	1/2	9/16	5/8	11/16	3/4	13/16	7/8
	15/16	1	1-1/16	1-1/8	1-3/16	1-1/4			

Item ID: M1215AF





### SOCKET SET

1/2" DRIVE 8 Pieces mm

- Long sockets for extra reach
- Chrome vanadium
- Satin finish for a better grip when handling the socket
- 6 point single hexagon socket for a better grip
- Ball bearing recess on the female end to grip the ratchet
- Supplied with a clip rail with socket clips for easy storage as a set
- Designed and manufactured to DIN3120/3124 and ISO2725

Clip rail (Length: 210mm), 1/2" Drive socket clips x8

Deep 6 point sockets:

mm:	13	14	15	17	19	21	22	24
-----	----	----	----	----	----	----	----	----

Item ID: M1208-6



### SOCKET SET

Stainless Steel 1/2" DRIVE 3 Pieces mm

- 4430 stainless steel making it ideal for the food, medical, aerospace and marine industries or for use in any acidic environment
- 6 point single hexagon sockets for a better grip
- Long sockets for extra reach
- Satin finish for a better grip when handling the socket
- Ball bearing recess on the female end to grip the ratchet
- Supplied with a clip rail with socket clips for easy storage as a set
- Designed and manufactured to DIN3120/3124 and ISO2725

Clip rail, 1/2" Drive socket clips x3

Deep stainless steel 6 point sockets:

mm:	17	19	21
-----	----	----	----

Item ID: MS1203



### HEX BIT SOCKET SET

1/2" DRIVE 9 Pieces mm

- Chrome vanadium
- S2 steel bits pressed in to the socket
- Satin finish for a better grip when handling the socket
- Designed for use with fastenings with a hexagon hole
- Use with in-hex screws or grub screws
- Designed and manufactured to DIN7422
- Supplied with a clip rail with socket clips for easy storage as a set

Clip rail (Length: 220mm), 1/2" Drive socket clips x9

Hex bit sockets:

mm:	5	6	7	8	9	10	12	14	17
-----	---	---	---	---	---	----	----	----	----

Item ID: M1212



### HEX BIT SOCKET SET

1/2" DRIVE 9 Pieces AF

- Chrome vanadium
- S2 steel bits pressed in to the socket
- Satin finish for a better grip when handling the socket
- Designed for use with fastenings with a hexagon hole
- Use with in-hex screws or grub screws
- Designed and manufactured to DIN7422
- Supplied with a clip rail with socket clips for easy storage as a set

Clip rail (Length: 220mm), 1/2" Drive socket clips x9

Hex bit sockets:

AF:	3/16	7/32	1/4	9/32	5/16	3/8	1/2	9/16	5/8
-----	------	------	-----	------	------	-----	-----	------	-----

Item ID: M1209AF



### HEX BIT SOCKET SET

1/2" DRIVE 6 Pieces mm

- Chrome vanadium
- 100mm long bits for reaching in to recesses
- S2 steel bits pressed in to the socket
- Satin finish for a better grip when handling the socket
- Designed for use with fastenings with a hexagon hole
- Use with in-hex screws or grub screws
- Designed and manufactured to DIN7422
- Supplied with a clip rail with socket clips for easy storage as a set

Clip rail (Length: 160mm), 1/2" Drive socket clips x6

Hex bit sockets (Length 100mm):

mm:	5	6	7	8	10	12			
-----	---	---	---	---	----	----	--	--	--

Item ID: M1211



**TX-E BIT SOCKET SET**



- Chrome vanadium
- Satin finish for a better grip when handling the socket
- Ball bearing recess on the female end to grip the ratchet
- Designed for use with protruding TX head screws
- Supplied with a clip rail with socket clips for easy storage as a set

Clip rail (Length: 220mm), 1/2" Drive socket clips x9										
TX-E bit sockets:										
	TX-E:	E10	E11	E12	E14	E16	E18	E20	E22	E24

Item ID: **M1210**



**TPX BIT SOCKET SET**



- Chrome vanadium
- S2 steel bits pressed in to the socket
- Satin finish for a better grip when handling the socket
- Designed for use with tamper proof TX fastenings
- Supplied with a clip rail with socket clips for easy storage as a set

Clip rail (Length: 220mm), 1/2" Drive socket clips x9										
TPX bit sockets:										
	TPX:	20	25	27	30	40	45	50	55	60

Item ID: **M1213TPX**



**TX BIT SOCKET SET**



- Chrome vanadium
- S2 steel bits pressed in to the socket
- Satin finish for a better grip when handling the socket
- Designed for use with TX fastenings
- Supplied with a clip rail with socket clips for easy storage as a set

Clip rail (Length: 220mm), 1/2" Drive socket clips x9										
TX bit sockets:										
	TX:	20	25	27	30	40	45	50	55	60

Item ID: **M1213TX**



Clip rails are a handy storage option for tool boxes. All TengTools individual sockets are supplied with a socket clip that can be used to add to a clip rail





3/4" DRIVE



### SOCKET SET

3/4" DRIVE 18 Pieces mm

- Regular 6 point single hexagon sockets for a better grip
- Chrome vanadium satin finish sockets
- Supplied in the unique TengTools carrying case
- Hard wearing case with distinctive branding
- Tools clearly laid out to easily identify which tool belongs where
- Designed and manufactured to DIN and ISO standards

Quick release 72 teeth ratchet, 200mm & 400mm Extension bars										
Sliding T-bar										
Regular 6 point sockets:										
mm:	19	21	22	24	27	30	32	33	34	
	36	38	41	46	50					

Item ID: T3418-6



### SOCKET SET

3/4" DRIVE 22 Pieces mm AF

- Regular 6 point single hexagon metric sockets for a better grip
- Regular 12 point bi-hexagon AF sockets for easier alignment
- Chrome vanadium satin finish sockets
- Supplied in the unique TengTools carrying case
- Hard wearing case with distinctive branding
- Tools clearly laid out to easily identify which tool belongs where
- Designed and manufactured to DIN and ISO standards

Quick release 72 teeth ratchet, 100mm, 200mm & 400mm Extension bars										
Sliding T-bar										
Regular 6 point sockets:										
mm:	19	21	24	27	32	34	36	50		
Regular 12 point sockets:										
AF:	7/8	1	1-1/8	1-3/16	1-5/16	1-1/2	1-5/8	1-3/16	2	

Item ID: T3422S



### RATCHET & ACCESSORIES SET

3/4" DRIVE 4 Pieces

- Socket accessory set
- Quick release and twist reverse action for easier use
- Sliding T bar and extension bars also included
- Designed and manufactured to DIN and ISO standards

Quick release 72 teeth ratchet, 200mm & 400mm Extension bars										
Sliding T-bar										

Item ID: TTX3404



Get organised!  
Tray Size  
**TTX**

**RATCHET & ACCESSORIES SET**

**3/4"**  
DRIVE **4**  
PIECES

- Socket accessory set
- With safety locking system to avoid tools being dropped
- Quick release and twist reverse action for easier use
- Sliding T bar and extension bars also included
- Designed and manufactured to DIN and ISO standards

Quick release 72 teeth ratchet, 200mm & 400mm Extension bars
Sliding T-bar

Item ID: **TTX3404S**



Get organised!  
Tray Size  
**TTX**

**SOCKET SET**

**3/4"**  
DRIVE **14**  
PIECES **mm**

- Chrome vanadium
- Satin finish for a better grip when handling the sockets
- 6 point single hexagon sockets for a better grip
- Designed and manufactured to DIN3120/3124

Regular 6 point sockets:									
mm:	19	21	22	24	27	30	32	33	34
	36	38	41	46	50				

Item ID: **TTX3414**

**NEW**



Get organised!  
Tray Size  
**TTX**

**EXTENDABLE RATCHET SET**

**3/4"**  
DRIVE **2**  
PIECES

- Ratchet with extendable handle 545 to 860mm
- Extension bar 16"
- Designed and manufactured according to DIN3122D

72 teeth 3/4" Drive Extendable Ratchet
16" Extension bar

Item ID: **TTX3402E**



Get organised!  
Tray Size  
**TTX**

**SOCKET SET**

**3/4"**  
DRIVE **14**  
PIECES **AF**

- Chrome vanadium
- Satin finish for a better grip when handling the sockets
- 12 point bi-hexagon sockets
- Designed and manufactured to DIN3120/3124

Regular 12 point sockets:									
AF:	7/8	15/16	1	1-1/16	1-1/8	1-3/16	1-1/4	1-5/16	1-3/8
	1-7/16	1-1/2	1-5/8	1-3/4	1-7/8				

Item ID: **TTX344F**



Get organised!  
Tray Size  
**TEX**

**RATCHET & ACCESSORIES SET**

**3/4"**  
DRIVE **3**  
PIECES **EVA**

- Quick release and twist reverse action for easier use
- Sliding T bar and 16" (400mm) extension also included
- Tools are held in place using three colour pre-cut EVA foam clearly showing where each tool belong
- Designed and manufactured to DIN and ISO standards

Quick release 72 teeth ratchet, 400mm Extension bar
Sliding T-bar

Item ID: **TEX3403**



Get organised!  
Tray Size  
**TEX**

**SOCKET SET**

**3/4"**  
DRIVE **10**  
PIECES **mm** **EVA**

- Chrome vanadium
- Satin finish for a better grip when handling the sockets
- 6 point single hexagon sockets for a better grip
- Tools are held in place using three colour pre-cut EVA foam clearly showing where each tool belongs
- Designed and manufactured to DIN3120/3124

Regular 6 point sockets:						
mm:	22	24	27	30	32	36
	38	41	46	50		

Item ID: **TEX3410**





1"  
DRIVE



1"  
DRIVE 15 Pieces mm

### SOCKET SET

- Regular 12 point bi-hexagon sockets
- Chrome vanadium satin finish sockets
- Supplied in a metal carrying case
- Designed and manufactured to DIN and ISO standards

Flip reverse ratchet head with quick release, 22" handle bar						
T-bar adaptor, 200mm & 400mm Extension bars						
Regular 12 point sockets:						
mm:	36	41	46	50	55	60
	65	70	75	80		

Item ID: M1115MM



## Mixed Drive Sets



1/4"  
DRIVE 1/2"  
DRIVE 72 Pieces mm

### SOCKET SET

- 6 point 1/4" drive single hexagon sockets for a better grip
- 12 point 1/2" drive bi-hexagon sockets for easier alignment
- Chrome vanadium satin finish sockets
- An extensive range of screwdriver, hex, XZN and TX bits
- Hard wearing case with distinctive branding
- Tools clearly laid out to easily identify which tool belongs where
- Designed and manufactured to DIN and ISO standards

1/4" Drive	Flip reverse ratchet, Bi-flex wrench, 4" Extension bar, Coupler adaptor				
1/2" Drive	Flip reverse ratchet, 5" & 10" Extension bars, Flex head adaptor, 3/8" F x 1/2" M T-bar adaptor, Universal joint				
1/4" Drive Regular 6 point sockets:					
mm:	4 5 5.5 6 7 8 10 11 12				
	13				
1/2" Drive Regular 12 point sockets:					
mm:	10 11 12 13 14 15 16 17 18				
	19 20 21 22 23 24 27				
Hex Keys					
1.5, 2, 2.5 mm					
1/4" Hex bits:					
	TX8, TX10, TX15, TX20, TX25, TX27, TX30, TX40				
	1/8", 9/64", 5/32", 3/16", 7/32", 1/4", 3/8"				
	3, 4, 5, 6, 8, 10		PH0, PH1, PH2, PH3		
	PZ1, PZ2, PZ3		4, 5, 5, 7		M5, M6

Item ID: T1272



**SOCKET & TOOL SET**

**1/4" DRIVE** **1/2" DRIVE** **95 Pieces** **mm**

- 6 point single hexagon sockets for a better grip
- Combination spanners, screwdrivers and screwdriver bits
- Chrome vanadium satin finish sockets and spanners
- Hard wearing case with distinctive branding
- Tools clearly laid out to easily identify which tool belongs where
- Designed and manufactured to DIN and ISO standards

1/4" Drive	Flip reverse ratchet, Universal joint, 2" & 4" Extension bars, Sliding T-bar, Spinner handle, Coupler adaptor, 50mm Magnetic bit holder										
1/2" Drive	Flip reverse ratchet, 5" & 10" Extension bars, 5/16" Hex coupler, 3/8" F x 1/2" M T-bar adaptor, Universal joint										
1/4" Drive 6 point sockets:											
Reg mm:	4	4.5	5	5.5	6	7	8	9	10		
	11	12	13								
Deep mm:	4	5	6	7	8	9	10	11	12		
	13										
1/2" Drive 6 point sockets:											
Reg mm:	10	11	12	13	14	15	17	19	22		
	24	27	30	32							
Spark plug sockets mm:	21										
Screwdrivers:		3	4		PH1	PH2		PZ1	PZ2		
Combination Spanners:	8, 10, 12, 13, 14, 17 mm										
1/4" Hex bits:		TX8, TX10, TX15, TX20, TX25, TX27, TX30, TX40									
		3, 4, 5, 6, 8, 10		PH0, PH1, PH2, PH3, PH4							
		PZ0, PZ1, PZ2, PZ3			4, 5.5, 7						
5/16" Hex bits:		TX45, TX50, TX55									

Item ID: **TM095**



**SOCKET SET**

**1/4" DRIVE** **3/8" DRIVE** **1/2" DRIVE** **106 Pieces** **mm**

- 6 point 1/4" & 3/8" drive sockets for a better grip
- 12 point 1/2" drive bi-hexagon sockets for easier alignment
- Combination spanners, double flex wrenches and adjustable wrench
- Chrome vanadium satin finish sockets and spanners
- Hard wearing case with distinctive branding
- Tools clearly laid out to easily identify which tool belongs where
- Designed and manufactured to DIN and ISO standards

1/4" Drive	Flip reverse ratchet, Universal joint, 2" & 3" Extension bars, Bi-flex wrench, Coupler adaptor, Bits driver, Magnetic bit holder										
3/8" Drive	Flip reverse ratchet, 3" & 6" Extension bars, Coupler adaptor, 3/8" F x 1/4" M, 3/8" F x 1/2" M T-bar adaptors, Universal joint										
1/2" Drive	2 1/2" & 10" Extension bars, 1/2" F x 3/8" M T-bar adaptor, Flex head adaptor										
1/4" Drive 6 point sockets:											
Reg mm:	4	5	6	7	8	10	12	13			
	6	7	8	10	12	13					
Deep mm:	6	7	8	10	12	13					
3/8" Drive 6 point sockets:											
Reg mm:	8	9	10	12	13	14	15	16	17		
	18	19	21	22							
Spark plug sockets mm:	16	21									
1/2" Drive 12 point sockets:											
Reg mm:	19	24	27	30	32						
Double flex wrenches:	8x9, 10x11, 12x13, 14x15 mm										
Combination Spanners:	8, 9, 10, 11, 12, 13, 14, 15, 16, 17, 18, 19 mm										
Adjustable wrench:	10"										
1/4" Hex bits:		TX8, TX10, TX15, TX20, TX25, TX27, TX30, TX40									
		TPX10, TPX15, TPX20, TPX25, TPX27, TPX30, TPX40									
		3, 4, 5, 6, 8, 10		PH0, PH1, PH2, PH3							
		PZ1, PZ2, PZ3			4, 5.5, 7						M5, M6

Item ID: **TM106**



### SOCKET SET

**1/4" DRIVE** **3/8" DRIVE** **1/2" DRIVE** **111 Pieces** **mm** **AF**

- Chrome vanadium satin finish sockets and spanners
- Supplied in the unique TengTools carrying case
- Hard wearing case with distinctive branding
- Tools clearly laid out to easily identify which tool belongs where
- Designed and manufactured to DIN and ISO standards

1/4" Drive	Flip reverse ratchet, 5/16" Hex coupler, 6" Flexible extension, 2" & 4" Extension bars, Spinner handle, Universal joint, 1/4"F x 3/8"M adaptor, 4" T-bar										
3/8" Drive	Flip reverse ratchet, 1/4" Hex bit holder, 3" & 6" Extension bars, Spinner handle, Universal joint, 3/8"F x 1/2"M adaptor, Spin disc										
1/2" Drive	Flip reverse ratchet, 5/16" Hex coupler, 2 1/2" & 10" Extension bars, 1/2"F x 3/8"M adaptor, Spin disc										
1/4" Drive 6 point sockets:											
Reg mm:	4	5	6	7	8	10	12				
Reg AF:	3/16	7/32	1/4	9/32	3/8	7/16					
3/8" Drive 6 point sockets:											
Reg mm:	8	9	10	12	13	14	15	16	17		
Deep mm:	8	9	10	12	13	14	15	16	17		
Reg AF:	3/8	7/16	1/2	9/16	11/16	3/4	13/16	7/8			
Deep AF:	3/8	7/16	1/2	9/16	11/16	3/4	13/16	7/8			
Spark plug sockets mm:	16	21									
1/2" Drive 6 point sockets:											
Reg mm:	17	24	27	32							
Reg AF:	11/16	3/4	13/16	7/8	1	1-3/16					
Double flex wrenches:	8x9, 10x11, 12x13, 14x15 mm										
Combination Spanners:	8, 9, 10, 11, 12, 13, 14, 15, 16, 17, 18, 19 mm										
Adjustable wrench:	10"										
1/4" Hex bits:	TX10, TX15, TX20, TX25, TX30, TX40  4, 5.5, 7 3, 4, 5, 6, 7, 10  1/8", 9/64", 5/32", 3/16", 1/4", 5/16" PZ1, PZ2, PZ3  PH1, PH2, PH3										
5/16" Hex bits:	TX45, TX50										

Item ID: **TM111**

### SOCKET SET

**1/4" DRIVE** **3/8" DRIVE** **1/2" DRIVE** **127 Pieces** **mm** **AF**

- Chrome vanadium satin finish sockets and spanners
- A range of combination spanners and adjustable wrench
- Hard wearing case with distinctive branding
- Tools clearly laid out to easily identify which tool belongs where
- Designed and manufactured to DIN and ISO standards

1/4" Drive	Flip reverse ratchet, Universal joint, 2" & 3" Extension bars, Coupler adaptor										
3/8" Drive	Flip reverse ratchet, 3" & 6" Extension bars, Universal joint, Coupler adaptor, 3/8"F x 1/4"M adaptor, 3/8"F x 1/2"M adaptor										
1/2" Drive	2 1/2" & 10" Extension bars, Flex head adaptor, 1/2"F x 3/8"M adaptor										
1/4" Drive 6 point sockets:											
Reg mm:	4	5	5.5	6	7	8	10	11	12		
	13										
Deep mm:	6	7	8	10	12	13					
Reg AF:	3/16	7/32	1/4	9/32	5/16	11/32	3/8	7/16	1/2		
3/8" Drive 6 point sockets:											
Reg mm:	8	9	10	11	12	13	14	15	16		
	17	18	19	21	22						
Reg AF:	5/16	3/8	7/16	1/2	9/16	5/8	11/16	3/4	13/16		
	7/8										
Spark plug sockets mm:	16	21									
1/2" Drive 12 point sockets:											
Reg mm:	19	24	27	30	32						
Ratcheting bits driver, Spanner ring, 10" Adjustable wrench											
Combination Spanners:	8, 9, 10, 11, 12, 13, 14, 15, 16, 17, 18, 19 mm										
1/4" Hex bits:	TX8, TX10, TX15, TX20, TX25, TX27, TX30, TX40 3, 4, 5, 6, 8, 10  1/8", 9/64", 5/32", 3/16", 1/4", 3/8" PZ1 (x2), PZ2 (x2), PZ3  PH0, PH1 (x2), PH3 4, 5.5, 7 (x2)  M5, M6										

Item ID: **TM127**



**Impact Sets** 



**XZN IMPACT BIT SOCKET SET**

**1/2" DRIVE** **6 Pieces** **mm**

- Chrome molybdenum with a manganese phosphate finish for added corrosion resistance
- Suitable for use with power tools
- DIN standard design for use with a retaining pin and ring
- Supplied in the unique TengTools case with a snap lock
- Hard wearing hinge with a metal pin for longer life

1/2" Drive Impact XZN bits sockets: 				
	Length 43mm:	14	16	18
	Length 78mm:	14	16	18

Item ID: **T9206**







Get organised!  
Tray Size  
TT

**IMPACT SOCKET SET**

**1/4" DRIVE** **3/8" DRIVE** **24 Pieces** **mm**

- Chrome molybdenum for use with power tools
- ANSI standard design for use with power tools with a ball bearing socket retainer

3/8" F x 1/4" M impact adaptor										
1/4" Drive Impact 6 point sockets: 										
	Reg mm:	6	7	8	10	13				
3/8" Drive Impact 6 point sockets: 										
	Reg mm:	8	10	11	12	13	14	16	17	19
	Deep mm:	8	10	11	12	13	14	16	17	19

Item ID: **TT9024**



Get organised!  
Tray Size  
TT

**IMPACT SOCKET ACCESSORY SET**

**1/2" DRIVE** **11 Pieces**

- A selection of extension bars and adaptors
- DIN standard design for use with a retaining pin and ring
- Chrome molybdenum for use with power tools

Impact Adaptors:	3/8" F x 1/2" M, 1/2" F x 3/4" M, 1/2" F x 3/8" M
Universal Joint, 3", 5" & 10" Extension bars	
Retaining rings & pins:	092194, 092244, P92320, P92325 x1

Item ID: **TT9207**



Get organised!  
Tray Size  
TT

**IMPACT SOCKET ACCESSORY SET**

**1/2" DRIVE** **11 Pieces**

- A selection of extension bars and adaptors
- For use with ANSI sockets
- Chrome molybdenum for use with power tools

Impact Adaptors:	3/8" F x 1/2" M, 1/2" F x 3/4" M, 1/2" F x 3/8" M
Universal Joint, 3", 5" & 10" Extension bars	
Retaining rings & pins:	092194, 092244, P92320, P92325 x1

Item ID: **TT9207A**





Get organised!  
Tray Size  
TT

**IMPACT SOCKET SET**

**1/2" DRIVE** **16 Pieces** **mm**

- ANSI standard design for use with power tools with a ball bearing socket retainer
- Chrome molybdenum for use with power tools

1/2" Drive Impact 6 point sockets: 									
	Reg mm:	13	15	16	17	18	19	22	24
	Deep mm:	13	15	16	17	18	19	22	24

Item ID: **TT9116N**





**NEW**



Get organised!

Tray Size

TT				
----	--	--	--	--

**1/2" DRIVE** **12 Pieces** **mm**

## IMPACT SOCKET SET

- DIN standard design for use with a retaining pin and ring
- Chrome molybdenum for use with power tools
- O-rings & pins included
- Designed and manufactured to DIN3129

1/2" Drive Impact 6 point sockets:							
Reg mm:	19	21	22	24	27	30	32
Deep mm:	19	21	22	24	27		

Item ID: **TT9212**



Get organised!

Tray Size

TT				
----	--	--	--	--

**1/2" DRIVE** **20 Pieces** **mm**

## IMPACT SOCKET SET

- DIN standard design for use with a retaining pin and ring
- Chrome molybdenum for use with power tools
- Designed and manufactured to DIN3129

Retaining rings & pins: 092194, 092244, P92320, P92325 x1								
1/2" Drive Impact 6 point sockets:								
Reg mm:	13	15	16	17	18	19	22	24
Deep mm:	13	15	16	17	18	19	22	24

Item ID: **TT9120DN**



Get organised!

Tray Size

TT				
----	--	--	--	--

**1/2" DRIVE** **8 Pieces** **mm**

## TORQUE STICK & WHEEL NUT SOCKET SET

- For the correct tightening of wheel nut sockets on cars
- When the correct torque is reached the torque stick socket end stops turning while the drive end springs back with each stroke
- Reduces the risk of sheared wheel nut bolts or distorted rims and brake discs
- Chrome molybdenum wheel nut sockets with protective inserts to avoid damage to wheels

3/8" x 1/2" Torque step up adaptor				
1/2" Drive Torque sticks:				
Nm:	90	110	120	140
1/2" Drive wheel nut sockets:				
mm:	17	19	21	

Item ID: **TTTS08**



Get organised!

Tray Size

TT				
----	--	--	--	--

**1/2" DRIVE** **12 Pieces**

## TX IMPACT BIT SOCKET SET

- Chrome molybdenum for use with power tools
- DIN standard design for use with a retaining pin and ring

1/2" Drive Impact TX bit sockets:								
TX:	10	15	20	25	27	30	40	45
	50	55	60	70				

Item ID: **TT9212TX**

DIN Standard sockets require a retaining ring and pin to safely secure the socket to the impact tool.





Get organised™  
Tray Size  
TT

**3/8" DRIVE** **1/2" DRIVE** **15 Pieces**

**HEX IMPACT BIT SOCKET SET**

- Chrome molybdenum for use with power tools
- DIN standard design for use with a retaining pin and ring
- Designed and manufactured to DIN3129

3/8" Drive Impact Hex bit sockets: 	
mm:	4 5 6 7 8 10 12
1/2" Drive Impact Hex bit sockets: 	
mm:	5 6 8 10 12 14 17 19

Item ID: **TT9015HX**



Get organised™  
Tray Size  
TTX

**3/4" DRIVE** **15 Pieces** **mm**

**IMPACT SOCKET SET**

- DIN standard design for use with a retaining pin and ring
- Chrome molybdenum for use with power tools
- Supplied in the unique TengTools drawer width TTX tray

3/4" Drive Impact 6 point sockets: 				
Reg mm:	19 (3/4")	24	27 (1-1/16")	28
	30 (1-3/16")	32	34	36
Deep mm:	19 (3/4")	24	27 (1-1/16")	
	30 (1-3/16")	32	33	36

Item ID: **TTX9415**



Get organised™  
Tray Size  
TTD

**3/4" DRIVE** **12 Pieces** **mm**

**IMPACT SOCKET SET**

- 7" impact extension bar included for reaching in to recessed wheels, etc
- DIN standard design for use with a retaining pin and ring (included)
- Chrome molybdenum for use with power tools
- Supplied in the unique TengTools double width TC tray

7" Extension bar						
Retaining rings & pins: 093538, P90437 x3						
3/4" Drive Impact 6 point sockets: 						
Reg mm:	19 (3/4")	24	27 (1-1/16")	30 (1-3/16")	32	33
	34	36	38			

Item ID: **TTD9416**



Get organised™  
Tray Size  
TED

**1/2" DRIVE** **21 Pieces** **mm** **EVA**

**IMPACT SOCKET SET**

- ANSI standard design for use with power tools with a ball bearing socket retainer
- Selection of extension bars and adaptors
- Supplied in the unique TengTools double width TC tray
- Tools are held in place using three colour pre-cut EVA foam clearly showing where each tool belongs

3" & 10" Extension bars, Universal joint, 3/8" F x 1/2" M & 1/2" F x 3/4" M Impact adaptors								
1/2" Drive Impact 6 point sockets: 								
Reg mm:	13	15	16	17	18	19	22	24
	13	15	16	17	18	19	22	24

Item ID: **TED9121**



### REGULAR IMPACT SOCKET SET

**3/8"**  
DRIVE **8** Pieces **mm**

- ANSI standard design for use with power tools with a ball bearing socket retainer
- Chrome molybdenum for use with power tools
- Supplied on a 290mm clip rail for storage as a set

Clip rail (Length: 290mm), 3/8" Drive socket clips x8

Impact 6 point sockets:

Reg mm:	8	10	11	13	14	16	17	19
---------	---	----	----	----	----	----	----	----

Item ID: **9381**



### DEEP IMPACT SOCKET SET

**3/8"**  
DRIVE **8** Pieces **mm**

- ANSI standard design for use with power tools with a ball bearing socket retainer
- Chrome molybdenum for use with power tools
- Supplied on a 290mm clip rail for storage as a set

Clip rail (Length: 290mm), 3/8" Drive socket clips x8

Impact 6 point sockets:

Deep mm:	8	10	11	13	14	16	17	19
----------	---	----	----	----	----	----	----	----

Item ID: **9386**



### REGULAR IMPACT SOCKET SET

**1/2"**  
DRIVE **10** Pieces **mm**

- ANSI standard design for use with power tools with a ball bearing socket retainer
- Chrome molybdenum for use with power tools
- Supplied on a clip rail for storage as a set

Clip rail (Length: 290mm), 1/2" Drive socket clips x10

Impact 6 point sockets:

Reg mm:	10	11	12	13	14	17	19	21
	22	24						

Item ID: **9121**



### DEEP IMPACT SOCKET SET

**1/2"**  
DRIVE **10** Pieces **mm**

- ANSI standard design for use with power tools with a ball bearing socket retainer
- Chrome molybdenum for use with power tools
- Supplied on a clip rail for storage as a set

Clip rail (Length: 290mm), 1/2" Drive socket clips x10

Impact 6 point sockets:

Deep mm:	10	11	12	13	14	17	19	21
	22	24						

Item ID: **9126**



### STUBBY IMPACT SOCKET SET

**1/2"**  
DRIVE **12** Pieces **mm**

- Short reach for use in confined spaces
- DIN standard design for use with a retaining pin and ring
- Chrome molybdenum for use with power tools
- Black phosphate finish for easy identification as an impact socket accessory
- Ring and pin fixing hole on the female end to secure the socket to the air gun
- Designed and manufactured to DIN3129

Clip rail (Length: 290mm), 1/2" Drive socket clips x10

Impact 6 point sockets:

Deep mm:	10	11	12	13	14	15	16	17
	19	21	22	24				

Item ID: **9207S12**



©  @thegirlonabike



# SOCKETS & ACCESSORIES

GET THE JOB DONE, **FAST**

The socket range includes drives from 1/4" to 1" and includes six-point sockets and twelve-point sockets, metric and imperial sizes as well as a wide range of bit sockets including Hex, TX, TX-E, and TPX.

## 72 Teeth Ratchets

72 teeth ratchets give a working arc of just 5 degrees, resulting in outstanding accessibility in confined areas

The ratchet head is sealed, which prevents dirt and dust from entering the mechanism – giving a longer life and trouble-free use

The rotation disc, to change direction, has a good grip for oily fingers or gloves

More teeth are engaged simultaneously – which means you can use greater force without the mechanism failing

Ergonomic bi-material grip for maximum comfort while using



Size clearly etched on the side of every socket

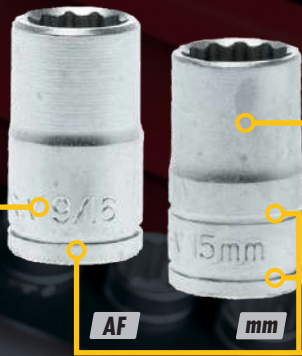

Made from extra strong chrome vanadium steel

Easily identify between metric & AF sockets as 2 rings are etched on the side of each metric socket and 1 ring on each AF socket

## 12 POINT V 6 POINT SOCKETS

12-point sockets, common in Aircraft Maintenance and Engineering, are ideal for use in confined space and for fast lightweight work. 6-point sockets are ideal for when extra torque needs to be applied. They are designed to contact the head of a fastener well away from the corners, this dramatically reduces the likelihood of slippage and rounding over of the corners.



### FRP Ratchets

Quick release mechanism that makes it possible to release sockets and accessories with one hand

Lever for quick reversing between left and right-hand action

Ratchet mechanism with 45 teeth (8 degree intervals)

All individual parts and service kits are available and easy to fit

Fibre ratchet handle with steel reinforcement that is lighter than standard ratchet handles, but just as strong

Bi-material handle with an ergonomic design that makes the ratchet very comfortable to use, especially in cold environments



## MINI BITS RATCHET



- 1/4" hex drive reversible bits ratchet
- Overall length 90mm making it very compact and easy to keep in the pocket
- Flip reverse mechanism for quickly changing between tightening and loosening
- Chrome vanadium satin finish drop forged steel
- For use with 1/4" drive hex bits
- 8mm double hexagon ring spanner on the other end

Item ID: 1400B

## RATCHET HEAD & BITS HOLDER



- Fine tooth mini ratchet head
- Designed for use together with any 1/4" hex drive bit holder
- 1/4" square drive for use with sockets and accessories
- 1/4" hexagon drive for use with screwdriver bits and accessories
- 72 teeth for use in confined spaces
- Flip reverse for quickly and easily changing between tightening and loosening
- Designed and manufactured to DIN3122D

Item ID: RHA14

## MINI PALM RATCHET



- Gearless palm ratchet
- 1/4" square drive for use with sockets and accessories
- 1/4" hexagon drive for use with screwdriver bits and accessories
- Handle designed for easy rotation with the fingers
- Use with an extension bar to create a ratcheting T bar
- Gearless mechanism for use in confined spaces
- Twist reverse for quickly and easily changing between tightening and loosening

Item ID: PM14

## MINI PALM RATCHET



- Handle designed for use in the palm of the hand
- Use with an extension bar to create a ratcheting T bar
- For use in confined spaces
- Twist reverse for quickly and easily changing between tightening and loosening
- Slim design together with a bi-material grip for extra comfort

Item ID: 1400M

## MINI RATCHET



- Fine tooth mini ratchet
- Shorter handle for easier use in confined spaces
- 72 teeth giving 5 degree increments between clicks
- Twist reverse for quickly and easily changing between tightening and loosening
- Slim design together with a bi-material grip for extra comfort
- Designed and manufactured to DIN3122D

Item ID: 1400-72MN

## 72 TEETH RATCHETS



- Fine tooth ratchet
- 72 teeth giving 5 degree increments between clicks
- Twist reverse for quickly and easily changing between tightening and loosening
- Slim design together with a bi-material grip for extra comfort
- Designed and manufactured to DIN3122D

ITEM ID:	Drive	Reverse	Quick Release	No. of Teeth	Length mm	Weight g
1400-72N	1/4"	Twist		72	150	110
3800-72N	3/8"	Twist	Y	72	203	265
1200-72N	1/2"	Twist	Y	72	250	400



**FLEX HEAD RATCHETS**

- Fine tooth stubby flex head ratchet
- Shorter handle for easier use in confined spaces
- Flexible ratchet head with locking mechanism for use at different angles
- 72 teeth giving 5 degree increments between clicks
- Twist reverse for quickly and easily changing between tightening and loosening
- Slim design together with a bi-material grip for extra comfort

ITEM ID:	Drive	Reverse	Quick Release	No. of Teeth	Length mm	g
1400-72SN	1/4"	Twist		72	121	114
3800-72SN	3/8"	Twist	Y	72	178	270
1200-72SN	1/2"	Twist	Y	72	190	395

**FLIP REVERSE RATCHETS**

- Fibre reinforced handle with three metal plates for added strength
- 45 teeth giving 8 degree increments between clicks
- Flip reverse for quickly and easily changing between tightening and loosening
- Quick release for easier changing between different sockets and accessories
- Bi-material grip for extra comfort
- Designed and manufactured to DIN3122D

ITEM ID:	Drive	Reverse	Quick Release	No. of Teeth	Length mm	g
1400FRP	1/4"	Flip	Y	45	150	96
3800FRP	3/8"	Flip	Y	45	203	227
1200FRP	1/2"	Flip	Y	45	255	358

**STAINLESS STEEL RATCHETS**

- Ideal for the food, medical, aerospace and marine industries or for use in any acidic environment
- 36 teeth giving 10 degree increments between clicks
- Flip reverse for quickly and easily changing between tightening and loosening
- Quick release for easier changing between different sockets and accessories

ITEM ID:	Drive	Reverse	Quick Release	No. of Teeth	Length mm	g
MS3800	3/8"	Flip	Y	36	204	424
MS1200	1/2"	Flip	Y	36	266	900

**LONG ARM FLEXIBLE RATCHET**



- 400mm long handle for added torque when needed
- Flexible ratchet head with locking mechanism for use at different angles
- 45 teeth giving 8 degree increments between clicks
- Twist reverse for quickly and easily changing between tightening and loosening
- Quick release for easier changing between different sockets and accessories
- Bi-material grip for extra comfort

Item ID: 1200F

**LONG ARM RATCHET**



- 400mm long handle for added torque when needed
- 45 teeth giving 8 degree increments between clicks
- Twist reverse for quickly and easily changing between tightening and loosening
- Quick release for easier changing between different sockets and accessories
- Bi-material grip for extra comfort

Item ID: 1200L

**HEAVY DUTY RATCHETS**

- Twist reverse for quickly and easily changing between tightening and loosening
- Quick release for easier changing between different sockets and accessories
- Rubber grip on the handle for a better grip particularly in wet or oily conditions
- Ball bearing socket retainer on the square drive to securely grip the socket

ITEM ID:	Drive	Reverse	Quick Release	No. of Teeth	Length mm	g
M3400-72	3/4"	Twist	Y	72	505	2000
M1100-72	1"	Twist	Y	72	800	4060





## NEW EXTENDABLE RATCHET

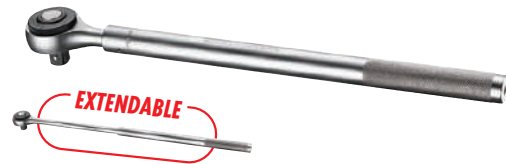

- Quick release button allowing the user to change quickly between sockets
- Twist reverse for changing between left and right direction
- Length is 545mm and extends to 860mm

ITEM ID:	Drive	Reverse	Quick Release	No. of Teeth	Length mm	Weight g
M340072E	3/4"	Twist	Y	72	545/860	3382

## HEAVY DUTY RATCHET



- Detachable head to enable the bar to be used as a power bar
- 24 teeth giving 15 degree increments between clicks
- Flip reverse for quickly and easily changing between tightening and loosening
- Quick release for easier changing of sockets
- Ball bearing socket retainer on the square drive
- Knurled grip area on the handle for a better grip particularly in wet or oily conditions
- Designed and manufactured to DIN3122D

ITEM ID:	Drive	Reverse	Quick Release	No. of Teeth	Length mm	Weight g
M1100	1"	Flip	Y	24	665	4410

## HEAVY DUTY RATCHET HEAD



- For use with the 1" power bar (M110020)
- 24 teeth giving 15 degree increments between clicks
- Flip reverse for quickly and easily changing between tightening and loosening
- Quick release for easier changing between different sockets and accessories
- Ball bearing socket retainer on the square drive to securely grip the socket
- Designed and manufactured to DIN3122D



ITEM ID:	Drive	Reverse	Quick Release	No. of Teeth	Length mm	Weight g
M110010	1"	Flip	Y	24	165	1740

## POWER BAR



- For use as a ratchet handle together with the M110010 ratchet head
- Can be used to create a power bar or T bar together with the M110030 T bar adaptor
- Chrome vanadium
- Satin finish for a better grip when handling sockets
- Ball bearing socket retainer on the square drive to securely grip the socket
- Knurled grip area on the handle for a better grip particularly in wet or oily conditions

Item ID: M110020

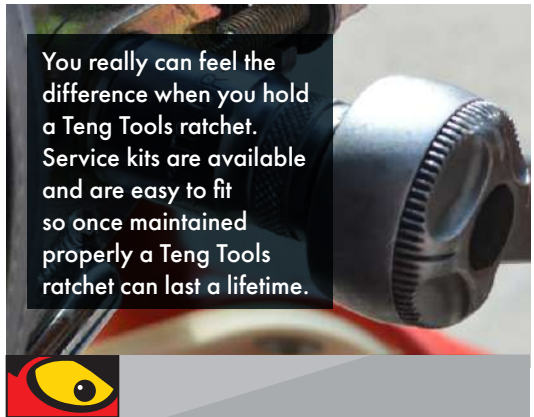

You really can feel the difference when you hold a Teng Tools ratchet. Service kits are available and are easy to fit so once maintained properly a Teng Tools ratchet can last a lifetime.

## RATCHET SERVICE KITS

- Full service kit for ratchets
- Includes a set of replacement parts for the ratchet mechanism
- Simple and quick to fit so the ratchet does not need to be sent away
- Reduces the amount of time that the ratchet is out of use

ITEM ID:	Drive	Service Kit For:
1400-72NRK	1/4"	1400-72N & 1400-72SN
1400FRPK	1/4"	1400FRP
3800-72NRK	3/8"	3800-72N & 3800-72SN
3800FRPK	3/8"	3800FRP
MS3800RK	3/8"	MS3800
1200-72NRK	1/2"	1200-72N & 1200-72SN
1200FRPK	1/2"	1200FRP
MS1200RK	1/2"	MS1200
1201RK	1/2"	1201
1201ARK	1/2"	1201A
1200FRK	1/2"	1200F & 1200L
M3400-72RK	3/4"	M3400-72
M1100-72RK	1"	M1100-72
M1100RK	1"	M1100 & M110010

**FLEXIBLE SPINNER HANDLE**

**1/4"**  
DRIVE

- Flexible spring wound shaft for easier access in confined spaces
- Overall length 275mm
- For use with 1/4" drive sockets and accessories
- Ergonomically designed bi-material handle for easy use with higher torque and faster speed
- Hole in the handle for hanging or for use as a T handle for extra torque or with a fall protection wire if needed



Item ID: MD514N

**SPINNER HANDLE**

**1/4"**  
DRIVE

- 6" (150mm) spinner handle and extension bar
- Ergonomically designed bi-material handle for easy use particularly in wet or oily conditions
- 1/4" drive female intake in the handle to enable use as an extension bar
- Chrome vanadium
- Satin finish for a better grip when handling sockets
- Ball bearing recess on the female end to grip the ratchet or power bar
- Ball bearing socket retainer on the male end to securely grip the socket
- Designed and manufactured to DIN3122E
- Supplied with a metal socket clip for use with a socket rail



Item ID: M140015-C

**FLEXIBLE SPINNER HANDLE**

**1/4"**  
DRIVE

- Long reach flexible socket driver
- Flexible spring wound shaft for easier access in confined spaces
- Protected by a plastic sleeve to avoid pinching
- Overall length 555mm
- For use with 1/4" drive sockets and accessories
- Ergonomically designed bi-material handle for easy use with higher torque and faster speed
- Hole in the handle for hanging or for use as a T handle for extra torque or with a fall protection wire if needed



Item ID: MD514L

**SPINNER HANDLE**

**3/8"**  
DRIVE

- 10" (250mm) spinner handle and extension bar
- Ergonomically designed bi-material handle for easy use particularly in wet or oily conditions
- 3/8" drive female intake in the handle to enable use as an extension bar
- Chrome vanadium
- Satin finish for a better grip when handling sockets
- Ball bearing recess on the female end to grip the ratchet or power bar
- Ball bearing socket retainer on the male end to securely grip the socket
- Designed and manufactured to DIN3122E
- Supplied with a metal socket clip for use with a socket rail



Item ID: M380015-C

**ROTATING SPINNER HANDLE**

**3/8"**  
DRIVE

- 10" (250mm) spinner handle and extension bar
- Rotating handle end creates an easy to use grip especially when using together with a ratchet
- Ergonomically designed bi-material handle for easy use particularly in wet or oily conditions
- 3/8" drive female intake in the handle to enable use as an extension bar
- Chrome vanadium
- Satin finish for a better grip when handling sockets
- Ball bearing recess on the female end to grip the ratchet or power bar
- Ball bearing socket retainer on the male end to securely grip the socket
- Designed and manufactured to DIN3122E
- Supplied with a metal socket clip for use with a socket rail



Item ID: PT3810R



Spinner handle with female intake in the handle can be used with a 3/8" drive ratchet as an extension bar show what we can do with it



## FLEX HANDLES



- Designed for extra torque to use with stubborn nuts and bolts
- Ball bearing socket retainer on the square drive for secure grip
- Chrome vanadium
- Satin finish for a better grip when handling sockets
- Ergonomically designed bi-material handle for easy use particularly in wet or oily conditions
- Designed and manufactured to DIN3122F

ITEM ID:	Drive	Length			Weight g
		AF	mm		
M380010A-C	3/8"	10"	250	Offset Shaft	375
M120010-C	1/2"	10"	265		492
1201	1/2"	17"	450		894
1201A	1/2"	24"	600		1198
M340070-C	3/4"	19"	480		1880
M340070S-C	3/4"	19"	480	Safety Locking	1880
M110070	1"	25"	650		3550



## FLEX HANDLE SERVICE KITS

- Includes a set of replacement parts for the square drive
- Simple to fit so the flex handle does not need to be sent away
- Reduces the time that the flex handle is out of use

ITEM ID:	Drive	Service Kit For:
1201RK	1/2"	1201
1201ARK	1/2"	1201A
M120010RK	1/2"	M120010RK
M340070RK	3/4"	M340070-C
M340070SRK	3/4"	M340070S-C
M110070RK	1"	M110070

## SPEED BRACES



- Designed to transport fastenings more quickly
- Ball bearing socket retainer on the square drive for secure grip
- Chrome vanadium
- Satin finish for a better grip when handling sockets
- Knurled grip area on the handle for a better grip particularly in wet or oily conditions

ITEM ID:	Drive	Length mm	Weight g
M380011-C	3/8"	380	310
M120011-C	1/2"	420	585

## EXTENSION BARS



- Ball bearing recess on the female end to grip the ratchet
- Ball bearing socket retainer on the male end to securely grip the socket
- Designed and manufactured to DIN3123B
- Supplied with a metal socket clip for use with a socket rail

ITEM ID:	Drive	Steel	Length		Safety Lock	Weight g
			AF	mm		
M140020-C	1/4"	Chrome Vanadium	2"	50	N	22
M140023-C	1/4"	Chrome Vanadium	3"	75	N	35
M140021-C	1/4"	Chrome Vanadium	4"	100	N	46
M140022-C	1/4"	Chrome Vanadium	6"	150	N	65
M140038-C	1/4"	Flexible Extension	6"	150	N	26
M140024-C	1/4"	Chrome Vanadium	12"	305	N	126
M380020-C	3/8"	Chrome Vanadium	3"	75	N	75
MS380020-C	3/8"	Stainless Steel	3"	75	N	72
M380023-C	3/8"	Chrome Vanadium	5"	125	N	120
MS380023-C	3/8"	Stainless Steel	5"	125	N	118
M380021-C	3/8"	Chrome Vanadium	6"	150	N	145
M380022-C	3/8"	Chrome Vanadium	10"	254	N	420
M380024-C	3/8"	Chrome Vanadium	20"	500	N	506
M120020-C	1/2"	Chrome Vanadium	2 1/2"	63.5	N	105
M120021-C	1/2"	Chrome Vanadium	5"	125	N	222
MS120021-C	1/2"	Stainless Steel	5"	125	N	222
M120023-C	1/2"	Chrome Vanadium	6"	150	N	240
M120022-C	1/2"	Chrome Vanadium	10"	255	N	420
M120024-C	1/2"	Chrome Vanadium	20"	500	N	855
M340020-C	3/4"	Chrome Vanadium	4"	100	N	400
M340020S-C	3/4"	Chrome Vanadium	4"	100	Y	450
M340021-C	3/4"	Chrome Vanadium	8"	200	N	700
M340021S-C	3/4"	Chrome Vanadium	8"	200	Y	750
M340022-C	3/4"	Chrome Vanadium	16"	400	N	1400
M340022S-C	3/4"	Chrome Vanadium	16"	400	Y	1400
M110040	1"	Chrome Vanadium	8"	200	N	1350
M110050	1"	Chrome Vanadium	16"	400	N	2400



## WOBBLE EXTENSION BARS



- Ball point end allows the socket to be turned even at an angle
- Ideal for use in confined spaces
- Satin finish for a better grip when handling sockets
- Ball bearing recess on the female end to grip the ratchet
- Ball bearing socket retainer on the male end to securely grip the socket
- Supplied with a metal socket clip for use with a socket rail

ITEM ID:	Drive	Steel	Length		Weight g
			AF	mm	
M380020W-C	3/8"	Chrome Vanadium	3"	75	63
M380021W-C	3/8"	Chrome Vanadium	6"	150	145
M380022W-C	3/8"	Chrome Vanadium	10"	255	234
M120020W-C	1/2"	Chrome Vanadium	3"	75	105
M120021W-C	1/2"	Chrome Vanadium	6"	150	240
M120022W-C	1/2"	Chrome Vanadium	10"	255	420



### EXTENSION BARS SET

13 Pieces

- Includes a selection of long and wobble extension bars
- TengTools T-HD handle included for a more comfortable grip
- Designed and manufactured to DIN and ISO standards

1/4" Drive	6" & 12" Extension bars, Universal joint
3/8" Drive	3" Wobble extension bar, 20" Extension bar, Universal joint, 3/8"F x 1/4"M T-bar adaptor
1/2" Drive	3" Wobble extension bar, 20" Extension bar, Universal joint
T-handle grip, 2mm & 2.5mm Mini Hex Screwdrivers	

Item ID: TTXEXT13



### EXTENSION BARS SET

13 Pieces EVA

- Includes a selection of long and wobble extension bars
- TengTools T-HD handle included for a more comfortable grip
- Tools are held in place using three colour pre-cut EVA foam clearly showing where each tool belong
- Designed and manufactured to DIN and ISO standards

1/4" Drive	6" & 12" Extension bars, Universal joint
3/8" Drive	3" Wobble extension bar, 20" Extension bar, Universal joint, 3/8"F x 1/4"M T-bar adaptor
1/2" Drive	3" Wobble extension bar, 20" Extension bar, Universal joint
T-handle grip, 2mm & 2.5mm Mini Hex Screwdrivers	

Item ID: TEXEXT13

## UNIVERSAL JOINTS

- Head rotates through 180° for use at different angles
- Ideal for use in confined spaces
- Chrome vanadium
- Satin finish for a better grip when handling sockets
- Ball bearing recess on the female end to grip the ratchet
- Ball bearing socket retainer on the male end to securely grip the socket
- Designed and manufactured to DIN3123C
- Supplied with a metal socket clip for use with a socket rail



ITEM ID:	Drive	Length mm	Weight g
M140030-C	1/4"	33	23
M380030-C	3/8"	50	65
M120030-C	1/2"	69	165
M340030-C	3/4"	108	570

## FLEX HEAD ADAPTOR

1/2" DRIVE

- Use to convert an extension bar into a flex handle
- Head rotates through 180° for use at different angles
- Designed for extra torque to use with stubborn nuts and bolts
- Can also be used straight to transport fastenings more quickly
- Chrome vanadium
- Satin finish for a better grip when handling the adaptor
- Supplied with a metal socket clip for use with a socket rail



Item ID: M120080-C





## ADAPTORS

- Satin finish for a better grip when handling sockets
- Ball bearing socket retainer on the male end to securely grip the socket
- Supplied with a metal socket clip for use with a socket rail



ITEM ID:	Drive	Steel	T-Drive Facility	Adaptor	Length mm	Weight g
M140036-C	1/4"	Chrome Vanadium	N	1/4"F - 3/8"M	25	20
M140037	1/4"	Chrome Vanadium	N	1/4"M - 1/4"Hex	25	7
M140039	1/4"	Chrome Vanadium	N	1/4"M - 1/4"Hex	30	10
M380035-C	3/8"	Chrome Vanadium	Y	3/8"F - 1/4"M	25.4	20
M380036-C	3/8"	Chrome Vanadium	Y	3/8"F - 1/2"M	36	45
MS380036-C	3/8"	Stainless Steel	Y	3/8"F - 1/2"M	36	45
M380037	3/8"	Chrome Vanadium	N	1/4"Hex - 3/8"M	32	14
M120036-C	1/2"	Chrome Vanadium	Y	1/2"F - 3/8"M	39.5	55
MS120036-C	1/2"	Stainless Steel	Y	1/2"F - 3/8"M	39.5	55
M120037-C	1/2"	Chrome Vanadium	N	1/2"F - 3/4"M	39.5	55
M340085-C	3/4"	Chrome Vanadium	N	3/4"F - 1"M	62	370
M340086-C	3/4"	Chrome Vanadium	Y	3/4"F - 1/2"M	40	164
M110030	1"	Chrome Vanadium	Y	1" T-Bar Adaptor	82	620

## COUPLER ADAPTORS

- Coupler adaptors for holding various bits
- Chrome vanadium
- Satin finish for a better grip when handling the adaptor
- Retaining spring to hold the bit in place
- Designed and manufactured to DIN ISO 1173
- Supplied with a metal socket clip for use with a socket rail



ITEM ID:	Drive	Coupler For	Length mm	Weight g
M140060-C	1/4"	1/4" Hex Bits	25	20
M380060-C	3/8"	1/4" Hex Bits	28	32
M380061-C	3/8"	10mm Hex Bits	28	32
M120060-C	1/2"	5/16" Hex Bits	38	88
M120061-C	1/2"	10mm Hex Bits	38	56
M120062-C	1/2"	12mm Hex Bits	38	62
M120063-C	1/2"	1/4" Hex Bits	25	88



## SOCKET ADAPTOR SET

17 Pieces

- A selection of extension bars and adaptors in one handy set
- A full range of converters and adaptors from 1/4" to 1" drive
- Includes regular, magnetic and quick chuck holders for use with 1/4" hex bits
- Designed and manufactured to DIN standard

1/4" Drive:	1/4" Hex Coupler, Hex bit adaptor, 50mm Hex bit adaptor	
3/8" Drive:	1/4" Hex Coupler, Hex bit adaptor, 50mm Hex bit adaptor	
1/2" Drive:	50mm Hex bit adaptor	
Step Up Adaptors:	1/4"F x 3/8"M	3/8" x 1/2"M
	1/2"F x 3/4"F	3/4"M - 1"F
Reducing Adaptors:	3/8"F x 1/4"M	1/2"F x 3/8"M
		3/4"F x 1/2"M
50mm & 70mm Magnetic bit holder, 50mm Chuck bit holder with quick release		

Item ID: TTADP17

## INSERT ADAPTORS

- Quickly steps up from one drive to the next
- Magnets retain the socket in place
- Ideal for use where space is limited or where a regular adaptor is not suitable



ITEM ID:	Drive	Adaptor	Length mm	Weight g
M140036M	1/4"	1/4"F - 3/8"M	28	18
M380036M	3/8"	3/8"F - 1/2"M	30	30
M120037M	1/2"	1/2"F - 3/4"M	45	86
M340085M	3/4"	3/4"F - 1"M	54	130

**INSERT ADAPTOR SET**



4 Pieces

- 4 piece insert adaptor set
- Enables the use of smaller drive ratchets and accessories with larger sockets, etc.
- Magnets retain the socket in place
- Ideal for use where space is limited or where a regular adaptor is not suitable

Step Up Adaptors:	1/4" F x 3/8" M	3/8" x 1/2" M
	1/2" F x 3/4" F	3/4" M - 1" F

Item ID: **MX04**

**SLIDING T-BARS**



- Use to create a T bar for fast transporting of the fastening
- Chrome vanadium
- Satin finish for a better grip when handling sockets
- Ball bearing socket retainer on the male end for secure grip
- Designed and manufactured to DIN3122A

ITEM ID:	Drive	Safety Lock	Length mm	 g
M140050-C	1/4"	N	106	40
M380050-C	3/8"	N	170	122
M120050-C	1/2"	N	243	300
M340050-C	3/4"	N	450	450
M340050S-C	3/4"	Y	450	450

**T-BAR HANDLE**

- T bar handle grip
- Plastic handle for use with T bars
- Use with TengTools extra long extension bars and 3/8" F: 1/4" M T bar adaptors
- Creates a much more comfortable grip



Item ID: **T-HD**



All Teng Tools sockets are developed with the non-slip "Hip Grip" system. This means that the socket grips on the flat surfaces of the nut rather than on the corner preventing damage and slipping.





### IMPACT ACCESSORIES



3/8"  
DRIVE

ITEM ID:	Drive	Description	Standard	Retaining Ring	Retaining Pin
980020-C	3/8"	3" extension bar	DIN	092416	P902515
980035-C	3/8"	3/8"F:1/4"M adaptor	DIN	092416	P902515
980036-C	3/8"	3/8"F:1/2"M adaptor	DIN	092416	P902515
980036A-C	3/8"	3/8"F:1/2"M adaptor	ANSI	-	-
980060-C	3/8"	Coupler adaptor: 1/4" hex	ANSI	-	-
980086	3/8"	3/8"M:5/16"hex	ANSI	-	-

1/2"  
DRIVE

ITEM ID:	Drive	Description	Standard	Retaining Ring	Retaining Pin
920020N	1/2"	3" extension bar	DIN	092194	P92320
920020AN	1/2"	3" extension bar	ANSI	-	-
920021N	1/2"	5" extension bar	DIN	092194	P92320
920021AN	1/2"	5" extension bar	ANSI	-	-
920023N	1/2"	10" extension bar	DIN	092194	P92320
920023AN	1/2"	10" extension bar	ANSI	-	-
920030N	1/2"	universal joint	DIN	092194	P92320
920030AN	1/2"	universal joint	ANSI	-	-
920036N	1/2"	1/2"F:3/8"M adaptor	DIN	092194	P92320
920036AN	1/2"	1/2"F:3/8"M adaptor	ANSI	-	-
920037N	1/2"	1/2"F:3/4"M adaptor	DIN	092194	P92320
920037AN	1/2"	1/2"F:3/4"M adaptor	ANSI	-	-
920060-C	1/2"	coupler adaptor: 5/16" hex	ANSI	-	-

3/4"  
DRIVE

ITEM ID:	Drive	Description	Standard	Retaining Ring	Retaining Pin
940022-C	3/4"	7" extension bar	DIN	095036	P90435
940030-C	3/4"	universal joint	DIN	093538	P90437
940037-C	3/4"	3/4"F:1/2"M adaptor	DIN	095036	P90435
940085-C	3/4"	3/4"F:1"M adaptor	DIN	095036	P90435

1"  
DRIVE

ITEM ID:	Drive	Description	Standard	Retaining Ring	Retaining Pin
910086	1"	1"F:3/4"M adaptor	DIN	097045	P90545

### RETAINING RINGS & PINS



- For use with DIN standard impact sockets & accessories

ITEM ID:	Description
P902515	Retaining pin 2.5x15mm
P902518	Retaining pin 2.5x18mm
P92320	Retaining pin 3x20mm
P90324	Retaining pin 3x24mm
P92325	Retaining pin 3x25mm
P90328	Retaining pin 3x28mm
P90332	Retaining pin 3x32mm
P90437	Retaining pin 4x37mm
P90433	Retaining pin 4x33mm
P90435	Retaining pin 4x35mm
P90445	Retaining pin 4x45mm
P90543	Retaining pin 5x43mm
P90545	Retaining pin 5x45mm
P90551	Retaining pin 5x51mm
P90675	Retaining pin 6x75mm
P906110	Retaining pin 6x110mm

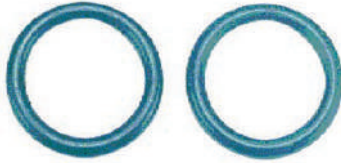

- For use with DIN standard impact sockets & accessories

ITEM ID:	Description
092416	Retaining ring 16x2.4mm
092419	Retaining ring 19x2.4mm
092194	Retaining ring 19x4.0mm
0935202	Retaining ring 20x3.5mm
092244	Retaining ring 24x4.0mm
093525	Retaining ring 25x3.5mm
093528	Retaining ring 28x3.5mm
093530	Retaining ring 30x3.5mm
093532	Retaining ring 32x3.5mm
093534	Retaining ring 34x3.5mm
095034	Retaining ring 34x5mm
095036	Retaining ring 36x5mm
093538	Retaining ring 38x3.5mm
097043	Retaining ring 43x7mm
097045	Retaining ring 45x7mm
093546	Retaining ring 46x3.5mm
095046	Retaining ring 46x5mm
093548	Retaining ring 48x3.5mm
097051	Retaining ring 51x7mm
095775	Retaining ring 75x5.7mm
0910075	Retaining ring 75x10mm
09100115	Retaining ring 115x10mm

**1/4" DRIVE**

**REGULAR METRIC SOCKETS**

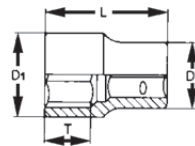

- 6 point single hexagon socket for a better grip
- Chrome vanadium
- Satin finish for a better grip when handling the socket
- Ball bearing recess on the female end to grip the ratchet
- Designed and manufactured to DIN3120/3124 and ISO2725
- Supplied with a metal socket clip for use with a socket rail



ITEM ID:	Size mm	L mm	Tmin mm	D1 mm	D2 mm	Weight g
M140504-C	4	25	3.6	6.9	12	10
M1405045-C	4.5	25	3.6	7.5	12	12
M140505-C	5	25	4.2	8.1	12	12
M1405055-C	5.5	25	4.2	8.8	12	12
M140506-C	6	25	4.8	9.4	12	12
M140507-C	7	25	4	10.9	12	13
M140508-C	8	25	4	12	11.4	13
M140509-C	9	25	4.5	13.2	11.9	13
M140510-C	10	25	6	14.7	12.9	17
M140511-C	11	25	6	16	12.9	20
M140512-C	12	25	7	16.9	13.4	21
M140513-C	13	25	7.5	17.7	13.9	24







## NEW REGULAR METRIC SOCKETS

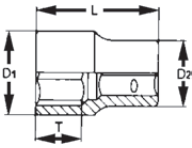

- 12 point single hexagon socket for a better grip
- Chrome vanadium
- Satin finish for a better grip when handling the socket
- Ball bearing recess on the female end to grip the ratchet
- Designed and manufactured to DIN3120/3124 and ISO2725
- Supplied with a metal socket clip for use with a socket rail

## REGULAR AF SOCKETS

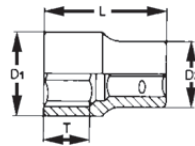

- 6 point single hexagon socket for a better grip
- Chrome vanadium
- Satin finish for a better grip when handling the socket
- Ball bearing recess on the female end to grip the ratchet
- Designed and manufactured to DIN3120/3124 and ISO2725
- Supplied with a metal socket clip for use with a socket rail

ITEM ID:	Size mm	L mm	Tmin mm	D1 mm	D2 mm	Weight g
M14050412-C	4	25	3.6	6.9	12	10
M14050512-C	5	25	4.2	8.1	12	12
M140505512-C	5.5	25	4.2	8.8	12	12
M14050612-C	6	25	4.8	9.4	12	12
M14050712-C	7	25	4	10.9	12	13
M14050812-C	8	25	4	12	11.4	13
M14050912-C	9	25	4.5	13.2	11.9	13
M14051012-C	10	25	6	14.7	12.9	17
M14051112-C	11	25	6	16	12.9	20
M14051212-C	12	25	7	16.9	13.4	21
M14051312-C	13	25	7.5	17.7	13.9	24

ITEM ID:	Size	L mm	Tmin mm	D1 mm	D2 mm	Weight g
M140106-C	3/16"	25	3.6	8	12	12
M140107-C	7/32"	25	4.2	8.8	12	12
M140108-C	1/4"	25	4.8	10	12	12
M140109-C	9/32"	25	4	12	10.9	13
M140110-C	5/16"	25	4	12	11.4	13
M140111-C	11/32"	25	4.5	13.2	11.9	18
M140112-C	3/8"	25	4.5	14.4	12.4	19
M140114-C	7/16"	25	6	16	12.9	22
M140116-C	1/2"	25	7.2	17.7	13.9	28



## DO'S & DONT'S OF SOCKETRY

- ✓ Use the right drive
- ✓ Use the correct socket size
- ✓ Check the thread direction
- ✓ Keep it clean and dry
- ✓ Use light oil on ratchet mechanisms
- ✗ Do not use with impact tools
- ✗ Do not use TPX on a TX fastenings
- ✗ Do not use poles to increase leverage

**NEW** REGULAR AF SOCKETS

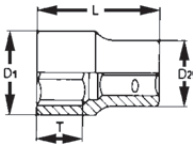

- 12 point single hexagon socket for a better grip
- Chrome vanadium
- Satin finish for a better grip when handling the socket
- Ball bearing recess on the female end to grip the ratchet
- Designed and manufactured to DIN3120/3124 and ISO2725
- Supplied with a metal socket clip for use with a socket rail

ITEM ID:	Size	L mm	Tmin mm	D1 mm	D2 mm	g
M14010612-C	3/16"	25	3.6	8	12	12
M14010712-C	7/32"	25	4.2	8.8	12	12
M14010812-C	1/4"	25	4.8	10	12	12
M14010912-C	9/32"	25	4	12	10.9	13
M14011012-C	5/16"	25	4	12	11.4	13
M14011112-C	11/32"	25	4.5	13.2	11.9	18
M14011212-C	3/8"	25	4.5	14.4	12.4	19
M14011412-C	7/16"	25	6	16	12.9	22
M14011612-C	1/2"	25	7.2	17.7	13.9	28

DEEP METRIC SOCKETS

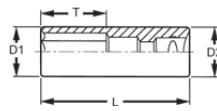

- 6 point single hexagon socket for a better grip
- Long sockets for extra reach
- Chrome vanadium
- Satin finish for a better grip when handling the socket
- Ball bearing recess on the female end to grip the ratchet
- Designed and manufactured to DIN3120/3124 and ISO2725
- Supplied with a metal socket clip for use with a socket rail

ITEM ID:	Size mm	L mm	Tmin mm	D1 mm	D2 mm	g
M140604-C	4	49.5	5	6.9	11.8	23
M140605-C	5	49.5	5.5	8	11.8	25
M1406055-C	5.5	49.5	5.5	8.8	11.8	26
M140606-C	6	49.5	6.5	9.4	11.8	26
M140607-C	7	49.5	10.5	10.9	11.8	27
M140608-C	8	49.5	10.5	11.8	11.8	30
M140609-C	9	49.5	11.5	12.8	12.8	37
M140610-C	10	49.5	13	14.5	14.5	38
M140611-C	11	49.5	14	15.6	15.6	43
M140612-C	12	49.5	15	16.6	16.6	46
M140613-C	13	49.5	17	17.6	17.6	48



All sockets are produced according to Teng Tools "hip grip" system, which means the socket grips on the flat surfaces of the nut rather than on the corner. This system helps to prevent damage to nuts and bolts and makes it possible to grip nuts and bolts which already have damaged corners.

**NEW** DEEP METRIC SOCKETS

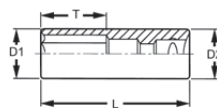

- 12 point single hexagon socket for a better grip
- Long sockets for extra reach
- Chrome vanadium
- Satin finish for a better grip when handling the socket
- Ball bearing recess on the female end to grip the ratchet
- Designed and manufactured to DIN3120/3124 and ISO2725
- Supplied with a metal socket clip for use with a socket rail

ITEM ID:	Size mm	L mm	Tmin mm	D1 mm	D2 mm	g
M14060612-C	6	49.5	6.5	9.4	11.8	26
M14060712-C	7	49.5	10.5	10.9	11.8	27
M14060812-C	8	49.5	10.5	11.8	11.8	30
M14061012-C	10	49.5	13	14.5	14.5	38
M14061212-C	12	49.5	15	16.6	16.6	46
M14061312-C	13	49.5	17	17.6	17.6	48



## DEEP AF SOCKETS

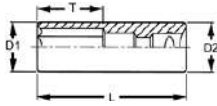

- 6 point single hexagon socket for a better grip
- Long sockets for extra reach
- Chrome vanadium
- Satin finish for a better grip when handling the socket
- Ball bearing recess on the female end to grip the ratchet
- Designed and manufactured to DIN3120/3124 and ISO2725
- Supplied with a metal socket clip for use with a socket rail

ITEM ID:	Size	L mm	Tmin mm	D1 mm	D2 mm	g
M140206-C	3/16"	49.5	5	8	11.8	24
M140207-C	7/32"	49.5	5.5	9	11.8	26
M140208-C	1/4"	49.5	6.5	10	11.8	27
M140209-C	9/32"	49.5	10.5	11	11.8	26
M140210-C	5/16"	49.5	10.5	11.8	11.8	30
M140211-C	11/32"	49.5	11.5	12.8	11.8	34
M140212-C	3/8"	49.5	12.5	14.5	14.5	37
M140214-C	7/16"	49.5	14.5	15.6	15.6	44
M140216-C	1/2"	49.5	16.5	17.6	17.6	48

## NEW DEEP AF SOCKETS

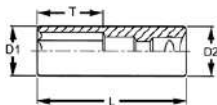

- 12 point single hexagon socket for a better grip
- Long sockets for extra reach
- Chrome vanadium
- Satin finish for a better grip when handling the socket
- Ball bearing recess on the female end to grip the ratchet
- Designed and manufactured to DIN3120/3124 and ISO2725
- Supplied with a metal socket clip for use with a socket rail

ITEM ID:	Size	L mm	Tmin mm	D1 mm	D2 mm	g
M14020612-C	3/16"	49.5	5	8	11.8	24
M14020712-C	7/32"	49.5	5.5	9	11.8	26
M14020812-C	1/4"	49.5	6.5	10	11.8	27
M14020912-C	9/32"	49.5	10.5	11	11.8	26
M14021012-C	5/16"	49.5	10.5	11.8	11.8	30
M14021112-C	11/32"	49.5	11.5	12.8	11.8	34
M14021212-C	3/8"	49.5	12.5	14.5	14.5	37
M14021412-C	7/16"	49.5	14.5	15.6	15.6	44
M14021612-C	1/2"	49.5	16.5	17.6	17.6	48

## TX-E BIT SOCKETS

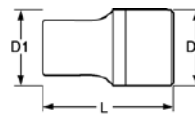

- Chrome vanadium
- Satin finish for a better grip when handling the socket
- Ball bearing recess on the female end to grip the ratchet
- Designed for use with protruding TX head screws
- Supplied with a metal socket clip for use with a socket rail

ITEM ID:	Size	Size mm	L mm	Tmin mm	D1 mm	D2 mm	g
M140704-C	E4	3.5	23.1	3.5	5.8	12	7
M140705-C	E5	4.5	24.8	4.5	6.8	12	8
M140706-C	E6	4.5	24.8	4.5	8	12	9
M140707-C	E7	5.6	24.8	5.6	9.4	12	10
M140708-C	E8	6	24.8	6	10.4	12	10

## FLAT BIT SOCKETS

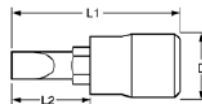

- Chrome vanadium
- S2 steel bits pressed in to the socket
- Satin finish for a better grip when handling the socket
- Ball bearing recess on the female end to grip the ratchet
- Designed for use with slotted type screws and fastenings
- Designed and manufactured to DIN5264
- Supplied with a metal socket clip for use with a socket rail

ITEM ID:	Width mm	Thickness mm	L1 mm	L2 mm	D mm	g
M141404-C	4	0.8	32	15	12	13
M1414055-C	5.5	1.0	32	15	12	13
M141407-C	7	1.4	32	15	12	14

**PH BIT SOCKETS**

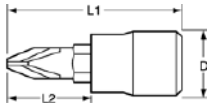

- Chrome vanadium
- S2 steel bits pressed in to the socket
- Satin finish for a better grip when handling the socket
- Ball bearing recess on the female end to grip the ratchet
- Designed for use with Phillips type screws and fastenings
- Designed and manufactured to DIN ISO 8764-1
- Supplied with a metal socket clip for use with a socket rail

ITEM ID:	Size	L1 mm	L2 mm	D mm	 g
M141300-C	PH0	32	15	12	13
M141301-C	PH1	32	15	12	13
M141302-C	PH2	32	15	12	13
M141303-C	PH3	32	15	12	13

**PZ BIT SOCKETS**

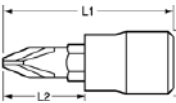

- Chrome vanadium
- S2 steel bits pressed in to the socket
- Satin finish for a better grip when handling the socket
- Ball bearing recess on the female end to grip the ratchet
- Designed for use with Pozidriv type screws and fastenings
- Supplied with a metal socket clip for use with a socket rail

ITEM ID:	Size	L1 mm	L2 mm	D mm	 g
M141601-C	PZ1	32	15	12	13
M141602-C	PZ2	32	15	12	13
M141603-C	PZ3	32	15	12	13

**TX BIT SOCKETS**

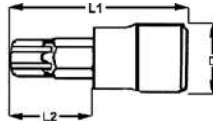

- Chrome vanadium
- S2 steel bits pressed in to the socket
- Satin finish for a better grip when handling the socket
- Ball bearing recess on the female end to grip the ratchet
- Designed for use with fastenings with a TX hole
- Supplied with a metal socket clip for use with a socket rail

ITEM ID:	Size	Size mm	L1 mm	L2 mm	D mm	 g
M141210T-C	TX10	2.5	32	15	12	13
M141215T-C	TX15	3	32	15	12	13
M141220T-C	TX20	3.5	32	15	12	13
M141225T-C	TX25	4.5	32	15	12	13
M141227T-C	TX27	5	32	15	12	14
M141230T-C	TX30	5.5	32	15	12	14
M141240T-C	TX40	6.5	32	15	12	14









**3/8"**  
DRIVE

## REGULAR METRIC SOCKETS

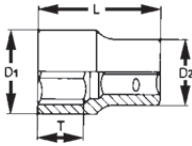
**3/8"**  
DRIVE  mm



- 6 point single hexagon socket for a better grip
- Chrome vanadium
- Satin finish for a better grip when handling the socket
- Ball bearing recess on the female end to grip the ratchet
- Designed and manufactured to DIN3120/3124 and ISO2725
- Supplied with a metal socket clip for use with a socket rail

ITEM ID:	Size mm	L mm	Tmin mm	D1 mm	D2 mm	 g
M380507-C	7	25.7	4	10.8	17.1	21
M380508-C	8	25.7	4.5	12	17.1	25
M380509-C	9	25.7	5	13.1	17.1	26
M380510-C	10	25.7	5	14.7	17.1	26
M380511-C	11	25.7	7	16	17.1	26
M380512-C	12	25.7	7	17.1	16.5	29
M380513-C	13	25.7	7	18.3	16.9	32
M380514-C	14	25.7	9	19.5	17.8	40
M380515-C	15	25.7	10	20.4	17.8	43
M380516-C	16	29	10	22.1	18.9	43
M380517-C	17	29	10	23.3	18.9	50
M380518-C	18	29	15.5	24.2	20	56
M380519-C	19	29	15.5	25.7	21	64
M380520-C	20	29	15.5	26.7	22	71
M380521-C	21	29	15.5	27.7	23	78
M380522-C	22	29	15.5	29.8	24	82

## NEW REGULAR METRIC SOCKETS

**3/8"**  
DRIVE  mm

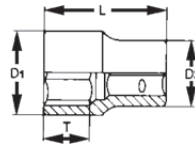

- 12 point single hexagon socket for a better grip
- Chrome vanadium
- Satin finish for a better grip when handling the socket
- Ball bearing recess on the female end to grip the ratchet
- Designed and manufactured to DIN3120/3124 and ISO2725
- Supplied with a metal socket clip for use with a socket rail

ITEM ID:	Size mm	L mm	Tmin mm	D1 mm	D2 mm	 g
M38050812-C	8	25.7	4.5	12	17.1	25
M38050912-C	9	25.7	5	13.1	17.1	26
M38051012-C	10	25.7	5	14.7	17.1	26
M38051112-C	11	25.7	7	16	17.1	26
M38051212-C	12	25.7	7	17.1	16.5	29
M38051312-C	13	25.7	7	18.3	16.9	32
M38051412-C	14	25.7	9	19.5	17.8	40
M38051512-C	15	25.7	10	20.4	17.8	43
M38051612-C	16	29	10	22.1	18.9	43
M38051712-C	17	29	10	23.3	18.9	50
M38051812-C	18	29	15.5	24.2	20	56
M38051912-C	19	29	15.5	25.7	21	64
M38052212-C	22	29	15.5	29.8	24	82

**REGULAR AF SOCKETS**

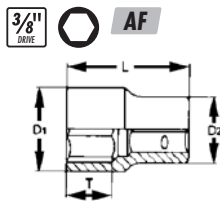

- 6 point single hexagon socket for a better grip
- Chrome vanadium
- Satin finish for a better grip when handling the socket
- Ball bearing recess on the female end to grip the ratchet
- Designed and manufactured to DIN3120/3124 and ISO2725
- Supplied with a metal socket clip for use with a socket rail

ITEM ID:	Size	L mm	Tmin mm	D1 mm	D2 mm	g
M380110-C	5/16"	25.7	4.5	11.7	17.1	23
M380112-C	3/8"	25.7	5	14.2	17.1	24
M380114-C	7/16"	25.7	7	16.3	17.1	26
M380116-C	1/2"	25.7	7	18.3	16.9	34
M380118-C	9/16"	25.7	9	19.5	17.8	38
M380120-C	5/8"	29	10	22.1	18.9	46
M380122-C	11/16"	29	10	24.2	20	50
M380124-C	3/4"	29	12	25.7	21	60
M380126-C	13/16"	29	13	27.7	23	68
M380128-C	7/8"	29	13	29.5	24	75

**STAINLESS STEEL SOCKETS**

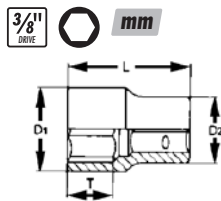

- 4430 stainless steel making it ideal for the food, medical, aerospace and marine industries or for use in any acidic environment
- Satin finish for a better grip when handling the socket
- 6 point single hexagon socket for a better grip
- Ball bearing recess on the female end to grip the ratchet
- Designed and manufactured to DIN3120/3124 and ISO2725
- Supplied with a metal socket clip for use with a socket rail

ITEM ID:	Size mm	L mm	Tmin mm	D1 mm	D2 mm	g
MS380519-C	8	26	6	12.1	16.8	22
MS380508-C	9	26	6	13	16.8	22
MS380509-C	10	26	6	14.6	16.8	23
MS380510-C	11	26	7	16	16.8	25
MS380511-C	12	26	7.4	16.8	16.5	24
MS380512-C	13	26	7.4	18	17.5	28
MS380513-C	14	26	10.5	19.2	17.8	29
MS380514-C	15	26	11.5	20.5	18	30
MS380515-C	16	29	13	21.8	18.5	41
MS380516-C	17	29	13	23	19	44
MS380517-C	18	29	13	24.2	20	47
MS380518-C	19	29	13.5	25.4	21	54

**NEW REGULAR AF SOCKETS**

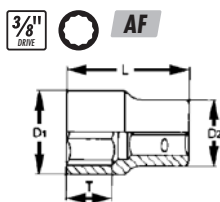

- 12 point single hexagon socket for a better grip
- Chrome vanadium
- Satin finish for a better grip when handling the socket
- Ball bearing recess on the female end to grip the ratchet
- Designed and manufactured to DIN3120/3124 and ISO2725
- Supplied with a metal socket clip for use with a socket rail

ITEM ID:	Size	L mm	Tmin mm	D1 mm	D2 mm	g
M38011212-C	3/8"	25.7	5	14.2	17.1	24
M38011412-C	7/16"	25.7	7	16.3	17.1	26
M38011612-C	1/2"	25.7	7	18.3	16.9	34
M38011812-C	9/16"	25.7	9	19.5	17.8	38
M38012012-C	5/8"	29	10	22.1	18.9	46
M38012212-C	11/16"	29	10	24.2	20	50
M38012412-C	3/4"	29	12	25.7	21	60



## DEEP METRIC SOCKETS

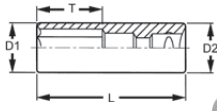

- 6 point single hexagon socket for a better grip
- Long sockets for extra reach
- Chrome vanadium
- Satin finish for a better grip when handling the socket
- Ball bearing recess on the female end to grip the ratchet
- Designed and manufactured to DIN3120/3124 and ISO2725
- Supplied with a metal socket clip for use with a socket rail

## NEW DEEP METRIC SOCKETS

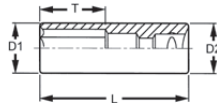

- 12 point single hexagon socket for a better grip
- Long sockets for extra reach
- Chrome vanadium
- Satin finish for a better grip when handling the socket
- Ball bearing recess on the female end to grip the ratchet
- Designed and manufactured to DIN3120/3124 and ISO2725
- Supplied with a metal socket clip for use with a socket rail

ITEM ID:	Size mm	L mm	Tmin mm	D1 mm	D2 mm	Weight g
M380607-C	7	45.5	10	10.8	16.5	40
M380608-C	8	45.5	12	12	16.5	50
M380609-C	9	45.5	14	13.1	16.5	55
M380610-C	10	45.5	15	14.7	16.5	60
M380611-C	11	45.5	17	16.5	16.5	70
M380612-C	12	45.5	18	17.1	17.1	75
M380613-C	13	45.5	18	18.5	18.5	85
M380614-C	14	50	18	19.5	19.5	95
M380615-C	15	53	20	20.4	20.4	100
M380616-C	16	53	20	22	22	105
M380617-C	17	56	20	23.3	23.3	120
M380618-C	18	56	20	24.2	24.2	125
M380619-C	19	56	20	25.7	25.7	130
M380620-C	20	63.5	22	26.8	26.8	140
M380621-C	21	63.5	22	27.7	27.7	165
M380622-C	22	63.5	22	29.5	29.5	165

ITEM ID:	Size mm	L mm	Tmin mm	D1 mm	D2 mm	Weight g
M38060712-C	7	45.5	10	10.8	16.5	40
M38060812-C	8	45.5	12	12	16.5	50
M38060912-C	9	45.5	14	13.1	16.5	55
M38061012-C	10	45.5	15	14.7	16.5	60
M38061112-C	11	45.5	17	16	16.5	70
M38061212-C	12	45.5	18	17.1	17.1	75
M38061312-C	13	45.5	18	18.5	18.5	85
M38061412-C	14	50	18	19.5	19.5	95
M38061512-C	15	53	20	20.4	20.4	100
M38061612-C	16	53	20	22	22	105
M38061712-C	17	56	20	23.3	23.3	120
M38061812-C	18	56	20	24.2	24.2	125
M38061912-C	19	56	20	25.7	25.7	130
M38062012-C	20	63.5	22	26.8	26.8	140
M38062112-C	21	63.5	22	27.7	27.7	165
M38062212-C	22	63.5	22	29.5	29.5	165



Don't waste valuable time searching for the socket that you need. Deep etching makes it easy to identify that 10mm socket at a glance.

**DEEP AF SOCKETS**

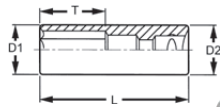

- 6 point single hexagon socket for a better grip
- Long sockets for extra reach
- Chrome vanadium
- Satin finish for a better grip when handling the socket
- Ball bearing recess on the female end to grip the ratchet
- Designed and manufactured to DIN3120/3124 and ISO2725
- Supplied with a metal socket clip for use with a socket rail

ITEM ID:	Size	L mm	Tmin mm	D1 mm	D2 mm	g
M380212-C	3/8"	45.5	15	14.2	16.5	43
M380214-C	7/16"	45.5	17	16.5	16.5	50
M380216-C	1/2"	45.5	18	18.5	18.5	62
M380218-C	9/16"	50	18	19.5	19.5	72
M380220-C	5/8"	53	20	22	22	97
M380222-C	11/16"	56	20	24.2	24.2	125
M380224-C	3/4"	56	22	25.7	25.7	130
M380226-C	13/16"	63.5	22	27.7	27.7	140
M380228-C	7/8"	63.5	22	29.5	29.5	165

**NEW DEEP AF SOCKETS**

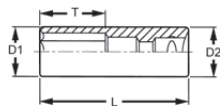

- 12 point single hexagon socket for a better grip
- Long sockets for extra reach
- Chrome vanadium
- Satin finish for a better grip when handling the socket
- Ball bearing recess on the female end to grip the ratchet
- Designed and manufactured to DIN3120/3124 and ISO2725
- Supplied with a metal socket clip for use with a socket rail

ITEM ID:	Size	L mm	Tmin mm	D1 mm	D2 mm	g
M38021212-C	3/8"	45.5	15	14.2	16.5	43
M38021412-C	7/16"	45.5	17	16.5	16.5	50
M38021612-C	1/2"	45.5	18	18.5	18.5	62
M38021812-C	9/16"	50	18	19.5	19.5	72
M38022012-C	5/8"	53	20	22	22	97
M38022212-C	11/16"	56	20	24.2	24.2	125
M38022412-C	3/4"	56	22	25.7	25.7	130

**T-BAR SOCKETS**

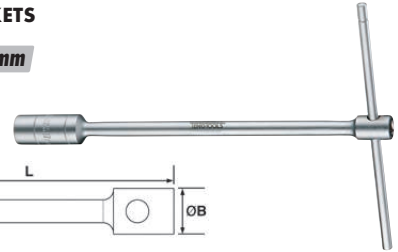
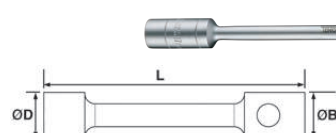

- 6 point single hexagon socket for a better grip
- Extra long sockets for extra reach
- Chrome vanadium
- Satin finish for a better grip when handling the socket
- Supplied with a sliding T bar for quicker tightening & loosening

ITEM ID:	Size mm	L mm	D mm	g
TBSKT07	7	300	10	200
TBSKT08	8	300	10	200
TBSKT10	10	300	10	220
TBSKT12	12	300	10	240
TBSKT13	13	300	10	240
TBSKT14	14	300	10	240
TBSKT17	17	300	12	340
TBSKT19	19	300	12	360
T-HD01	200mm x 8mm Replacement bar for use with T-bar sockets			



**LONG T-BAR SOCKET SET**



- Extra long socket set
- 3/8" drive extra long sockets for use in hard to reach places
- T bar with the TengTools T-HD handle for more comfortable use

2 Piece T-bar handle									
3/8" Drive extra long sockets:									
	mm:	8	10	12	13	14	17	19	

Item ID: **TTXTB09**



## T-BAR SOCKET SET

3/8" DRIVE 10 Pieces mm

- Extra long sockets for extra reach
- 6 point single hexagon socket for a better grip
- T bar with the TengTools T-HD handle for more comfortable use
- Chrome vanadium satin finish for a better grip
- Supplied with a sliding T bar for quicker tightening & loosening
- Supplied in a handy tool roll style wallet

2 Piece T-bar handle									
300mm long deep sockets:									
	mm:	7	8	10	12	13	14	17	19

Item ID: **TBW10**

## TX-E BIT SOCKETS

3/8" DRIVE

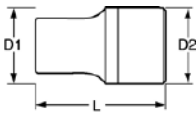

- Chrome vanadium
- Satin finish for a better grip when handling the socket
- Ball bearing recess on the female end to grip the ratchet
- Designed for use with protruding TX head screws
- Supplied with a metal socket clip for use with a socket rail

ITEM ID:	Size	Size mm	L mm	T mm	D1 mm	D2 mm	g
M380710-C	E10	7.2	28	7.2	13	17	25
M380712-C	E12	7.7	28	7.7	15	17	25
M380714-C	E14	9.6	28	9.6	16.3	18	30
M380716-C	E16	10.8	28	10.8	20	20	35
M380718-C	E18	12	28	12	22	22	40

## HEX BIT SOCKETS

3/8" DRIVE mm

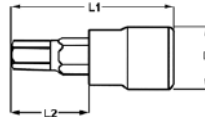

- Chrome vanadium
- S2 steel bits pressed in to the socket
- Satin finish for a better grip when handling the socket
- Ball bearing recess on the female end to grip the ratchet
- Designed for use with fastenings with a hexagon hole
- Use with in-hex screws or grub screws
- Designed and manufactured to DIN7422
- Supplied with a metal socket clip for use with a socket rail

ITEM ID:	Size mm	L1 mm	L2 mm	D mm	g
M381503-C	3	49.5	23	17.9	36
M381504-C	4	49.5	23	17.9	37
M381505-C	5	49.5	23	17.9	38
M3815055-C	5.5	49.5	23	17.9	38
M381506-C	6	49.5	23	17.9	38
M381507-C	7	49.5	23	17.9	38
M381508-C	8	49.5	23	17.9	40
M381510-C	10	49.5	23	17.9	52
M381512-C	12	49.5	23	22	56

## HEX BIT SOCKETS

3/8" DRIVE AF

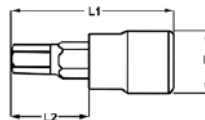

- Chrome vanadium
- S2 steel bits pressed in to the socket
- Satin finish for a better grip when handling the socket
- Ball bearing recess on the female end to grip the ratchet
- Designed for use with fastenings with a hexagon hole
- Use with in-hex screws or grub screws
- Designed and manufactured to DIN7422
- Supplied with a metal socket clip for use with a socket rail

ITEM ID:	Size	L1 mm	L2 mm	D mm	g
M381103-C	3/32"	49.5	23	17.9	36
M381104-C	1/8"	49.5	23	17.9	36
M381105-C	5/32"	49.5	23	17.9	38
M381106-C	3/16"	49.5	23	17.9	38
M381107-C	7/32"	49.5	23	17.9	38
M381108-C	1/4"	49.5	23	17.9	40
M381110-C	5/16"	49.5	23	17.9	40
M381112-C	3/8"	49.5	23	17.9	42



**TX BIT SOCKETS**

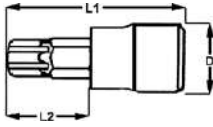

- Chrome vanadium
- S2 steel bits pressed in to the socket
- Satin finish for a better grip when handling the socket
- Ball bearing recess on the female end to grip the ratchet
- Designed for use with fastenings with a TX hole
- Supplied with a metal socket clip for use with a socket rail

ITEM ID:	Size	Size mm	L1 mm	L2 mm	D mm	g
M381210T-C	TX10	2.5	49.5	23	17.9	36
M381215T-C	TX15	3	49.5	23	17.9	36
M381220T-C	TX20	3.5	49.5	23	17.9	36
M381225T-C	TX25	4.5	49.5	23	17.9	36
M381227T-C	TX27	5	49.5	23	17.9	37
M381230T-C	TX30	5.5	49.5	23	17.9	37
M381240T-C	TX40	6.5	49.5	23	17.9	40
M381245T-C	TX45	7.5	49.5	23	17.9	45
M381250T-C	TX50	8.8	49.5	23	17.9	50

**TPX BIT SOCKETS**

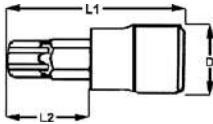

- Chrome vanadium
- S2 steel bits pressed in to the socket
- Satin finish for a better grip when handling the socket
- Ball bearing recess on the female end to grip the ratchet
- Designed for use with fastenings with a TX hole with a security pin
- Supplied with a metal socket clip for use with a socket rail

ITEM ID:	Size	Size mm	L1 mm	L2 mm	D mm	g
M381210-C	TPX10	2.5	49.5	23	17.9	36
M381215-C	TPX15	3	49.5	23	17.9	36
M381220-C	TPX20	3.5	49.5	23	17.9	36
M381225-C	TPX25	4.5	49.5	23	17.9	36
M381227-C	TPX27	5	49.5	23	17.9	37
M381230-C	TPX30	5.5	49.5	23	17.9	37
M381240-C	TPX40	6.5	49.5	23	17.9	40
M381245-C	TPX45	7.5	49.5	23	17.9	45
M381250-C	TPX50	8.8	49.5	23	17.9	50

**CROW FOOT WRENCHES**

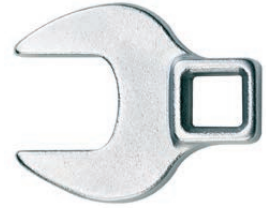
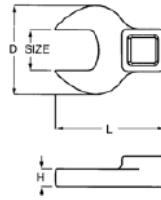

- Open ended spanner at right angle to square drive
- Ideal for accessing confined spaces
- Use with a ratchet or torque wrench with an extension bar
- Satin finish chrome vanadium
- Supplied with a metal socket clip for use with a socket rail

ITEM ID:	Size	L mm	H mm	D mm	g
M386510-C	10	32.3	4.8	21.3	36
M386511-C	11	34.3	5.2	23.1	50
M386512-C	12	36.2	5.6	25.5	58
M386513-C	13	37.4	6	26.9	70
M386514-C	14	40	6.2	30.2	86
M386515-C	15	41.3	6.7	33.3	90
M386516-C	16	41.3	6.7	33.3	114
M386517-C	17	45.5	8.5	38.1	116
M386518-C	18	45.5	8.5	38.1	140
M386519-C	19	47.6	8.5	39.6	168



**CROW FOOT WRENCH SET**

- Open ended spanner at right angle to square drive
- Ideal for accessing confined spaces
- Use with a ratchet or torque wrench with an extension bar
- Satin finish chrome vanadium
- Supplied with a clip rail with socket clips for easy storage

3/8" Drive Crow Foot Wrenches
10, 11, 12, 13, 16, 17, 18, 19 mm

Item ID: **M3808MM**



1/2"  
DRIVE

## REGULAR METRIC 6 POINT SOCKETS

1/2"  
DRIVE mm

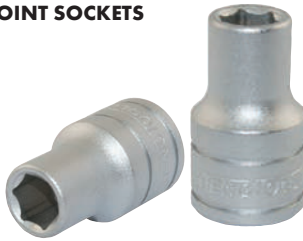
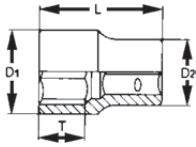

- 6 point single hexagon socket for a better grip
- Chrome vanadium
- Satin finish for a better grip when handling the socket
- Ball bearing recess on the female end to grip the ratchet
- Designed and manufactured to DIN3120/3124 and ISO2725
- Supplied with a metal socket clip for use with a socket rail

ITEM ID:	Size mm	L mm	Tmin mm	D1 mm	D2 mm	g
M1205106-C	10	38	10	15.5	21.8	45
M1205116-C	11	38	10	16.7	21.8	47
M1205126-C	12	38	10	18	21.8	49
M1205136-C	13	38	10	19.2	21.8	50
M1205146-C	14	38	10	20.5	21.8	50
M1205156-C	15	38	14	21	21.8	51
M1205166-C	16	38	14.3	22.5	23.3	55
M1205176-C	17	38	14.3	24.2	23	57
M1205186-C	18	38	15.3	24.7	23	61
M1205196-C	19	38	16.7	26.3	24	63
M1205206-C	20	38	17.3	27	24	66
M1205216-C	21	38	18	28	24	71
M1205226-C	22	40	18	29.8	26	97
M1205236-C	23	40	18	30.8	27	96
M1205246-C	24	40	18	31.8	26	93
M1205256-C	25	40	20	33.4	28	136
M1205266-C	26	40	20	34.8	29	140
M1205276-C	27	43	20	35.8	30	148
M1205286-C	28	43	20	37.8	31	172
M1205296-C	29	43	20	38.8	32	180
M1205306-C	30	43	20	39.8	33	180
M1205326-C	32	43	22	41.8	35	201
M1205336-C	33	45.5	23.5	42.8	35	235
M1205346-C	34	45.5	23.5	43.8	36	223

## REGULAR METRIC SOCKETS

1/2"  
DRIVE mm

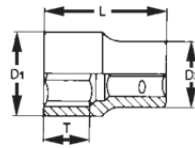

- 12 point bi-hexagon socket for easier alignment
- Chrome vanadium
- Satin finish for a better grip when handling the socket
- Ball bearing recess on the female end to grip the ratchet
- Designed and manufactured to DIN3120/3124 and ISO2725
- Supplied with a metal socket clip for use with a socket rail

ITEM ID:	Size mm	L mm	Tmin mm	D1 mm	D2 mm	g
M120508-C	8	38	9	13	21.8	43
M120509-C	9	38	10	14.5	21.8	45
M120510-C	10	38	10	15.5	21.8	45
M120511-C	11	38	10	16.7	21.8	47
M120512-C	12	38	10	18	21.8	49
M120513-C	13	38	10	19.2	21.8	50
M120514-C	14	38	10	20.5	21.8	50
M120515-C	15	38	14	21	21.8	51
M120516-C	16	38	14.3	22.5	23.3	55
M120517-C	17	38	15.3	24.2	23	57
M120518-C	18	38	16.7	24.7	23	61
M120519-C	19	38	17.3	26.3	24	63
M120520-C	20	38	18	27	23.7	66
M120521-C	21	38	18	28	24	68
M120522-C	22	40	18	29.8	26	92
M120523-C	23	40	18	30.8	27	92
M120524-C	24	40	20	31.8	26	95
M120525-C	25	40	20	33.4	28	136
M120526-C	26	40	20	34.8	29	140
M120527-C	27	43	20	35.8	30	148
M120528-C	28	43	20	37.8	31	172
M120529-C	29	43	20	38.8	32	180
M120530-C	30	43	22	39.8	33	172
M120532-C	32	43	23	41.8	35	189
M120534-C	34	45.5	23	43.8	36	223



**REGULAR AF SOCKETS**

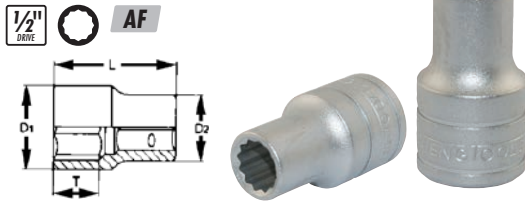

- 12 point bi-hexagon socket for easier alignment
- Chrome vanadium
- Satin finish for a better grip when handling the socket
- Ball bearing recess on the female end to grip the ratchet
- Designed and manufactured to DIN3120/3124 and ISO2725
- Supplied with a metal socket clip for use with a socket rail

ITEM ID:	Size mm	L mm	Tmin mm	D1 mm	D2 mm	g
M120112-C	3/8"	38	9	14.7	21.8	46
M120114-C	7/16"	38	9	17	21.8	50
M120116-C	1/2"	38	10	19	21.8	52
M120118-C	9/16"	38	12.5	20.8	21.8	55
M120119-C	19/32"	38	16	21	21.8	51
M120120-C	5/8"	38	14.3	22.5	23.3	62
M120122-C	11/16"	38	14.3	24.2	23.5	72
M120124-C	3/4"	38	20	26.3	24	76
M120125-C	25/32"	38	16	26.8	24	66
M120126-C	13/16"	38	20	27.7	24	80
M120128-C	7/8"	40	21	29.8	26	95
M120130-C	15/16"	40	21	31.8	26	110
M120132-C	1"	43	21	33.8	27.5	120
M120134-C	1-1/16"	43	23	35.8	29	145
M120136-C	1-1/8"	43	23	37.8	30.5	150
M120138-C	1-3/16"	43	23	39.8	32.5	190
M120140-C	1-1/4"	43	23	40.8	34	205

**STAINLESS STEEL SOCKETS**



- 4430 stainless steel making it ideal for the food, medical, aerospace and marine industries or for use in any acidic environment
- Satin finish for a better grip when handling the socket
- 6 point single hexagon socket for a better grip
- Ball bearing recess on the female end to grip the ratchet
- Designed and manufactured to DIN3120/3124 and ISO2725
- Supplied with a metal socket clip for use with a socket rail

ITEM ID:	Size mm	L mm	Tmin mm	D1 mm	D2 mm	g
MS1205106-C	10	38.5	10	15.5	21.5	50
MS1205116-C	11	38.5	10	16.7	21.5	51
MS1205126-C	12	38.5	10	18	21.5	51
MS1205136-C	13	38.5	10	19.2	21.5	53
MS1205146-C	14	38.5	10	20.5	21.5	55
MS1205156-C	15	38.5	13	21.1	21.6	55
MS1205166-C	16	38.5	13	22.5	23	65
MS1205176-C	17	38.5	13	24.2	23	75
MS1205186-C	18	38.5	13	25.5	23.5	83
MS1205196-C	19	38.5	16.7	26	24	76
MS1205216-C	21	39	17	27.5	24	76
MS1205246-C	24	39.5	18	31.5	26	102





## DEEP METRIC 6 POINT SOCKETS

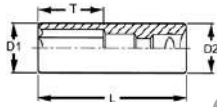

- 6 point single hexagon socket for a better grip
- Chrome vanadium
- Satin finish for a better grip when handling the socket
- Ball bearing recess on the female end to grip the ratchet
- Designed and manufactured to DIN3120/3124 and ISO2725
- Supplied with a metal socket clip for use with a socket rail

## DEEP METRIC 12 POINT SOCKETS

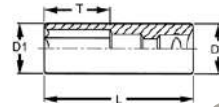

- 12 point bi-hexagon socket for easier alignment
- Chrome vanadium
- Satin finish for a better grip when handling the socket
- Ball bearing recess on the female end to grip the ratchet
- Designed and manufactured to DIN3120/3124 and ISO2725
- Supplied with a metal socket clip for use with a socket rail

ITEM ID:	Size	L mm	Tmin mm	D1 mm	D2 mm	g
M1206136-C	13	79	21	19.2	22	135
M1206146-C	14	79	25	20.5	22	135
M1206156-C	15	79	28	21.5	22	135
M1206166-C	16	79	31	22.5	23.3	150
M1206176-C	17	79	34	24.2	24.2	155
M1206186-C	18	79	34	25.4	25.4	165
M1206196-C	19	79	34	26.7	26.7	190
M1206246-C	24	79	34	31.8	31.8	240

ITEM ID:	Size mm	L mm	Tmin mm	D1 mm	D2 mm	g
M120610-C	10	79	17	15.5	22	125
M120611-C	11	79	18	16.7	22	130
M120612-C	12	79	19	18	22	130
M120613-C	13	79	21	19.2	22	135
M120614-C	14	79	25	20.5	22	135
M120615-C	15	79	28	21.5	22	135
M120616-C	16	79	31	22.5	23.3	150
M120617-C	17	79	24	24.2	24.2	155
M120618-C	18	79	34	25.4	25.4	165
M120619-C	19	79	34	26.7	26.7	190
M120620-C	20	79	34	27.8	27.8	195
M120621-C	21	79	34	27.8	27.8	184
M120622-C	22	79	34	29.8	29.8	230
M120624-C	24	79	34	31.8	31.8	240
M120627-C	27	79	34	35.8	35.8	280
M120630-C	30	79	34	39.8	39.8	360
M120632-C	32	79	34	41.3	41.3	380
M120636-C	36	79	34	46	46	390



**DEEP STAINLESS STEEL SOCKETS**

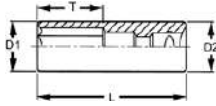

- 4430 stainless steel making it ideal for the food, medical, aerospace and marine industries or for use in any acidic environment
- Satin finish for a better grip when handling the socket
- 6 point single hexagon socket for a better grip
- Ball bearing recess on the female end to grip the ratchet
- Designed and manufactured to DIN3120/3124 and ISO2725
- Supplied with a metal socket clip for use with a socket rail

ITEM ID:	Size mm	L mm	Tmin mm	D1 mm	D2 mm	g
MS1206176-C	17	79	33	24.2	24.2	149
MS1206196-C	19	79	33	26.5	26.5	183
MS1206216-C	21	79	33	27.5	27.5	187

**TX-E BIT SOCKETS**

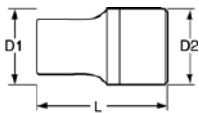

- Chrome vanadium
- Satin finish for a better grip when handling the socket
- Ball bearing recess on the female end to grip the ratchet
- Designed for use with protruding TX head screws
- Supplied with a metal socket clip for use with a socket rail

ITEM ID:	Size	Size mm	L mm	Tmin mm	D1 mm	D2 mm	g
M120710-C	E10	9.5	37.8	9.5	13.1	23.5	39
M120711-C	E11	9.5	37.8	9.5	14.1	23.5	42
M120712-C	E12	9.5	37.8	9.5	14.9	23.5	43
M120714-C	E14	12.3	37.8	12.3	16.7	23.5	44
M120716-C	E16	13	37.8	13	19.1	23.5	49
M120718-C	E18	13	37.8	13	20.9	23.5	52
M120720-C	E20	13	37.8	13	23.7	23.5	60
M120722-C	E22	16.1	37.8	16.1	26.1	26.1	82
M120724-C	E24	16.4	37.8	16.4	28	28	102

**HEX BIT SOCKETS**

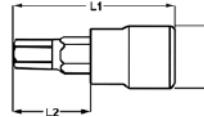

- Chrome vanadium
- S2 steel bits pressed in to the socket
- Satin finish for a better grip when handling the socket
- Ball bearing recess on the female end to grip the ratchet
- Designed for use with fastenings with a hexagon hole
- Use with in-hex screws or grub screws
- Designed and manufactured to DIN7422
- Supplied with a metal socket clip for use with a socket rail

ITEM ID:	Size mm	L1 mm	L2 mm	D mm	g
M121505-C	5	55	20.5	22	52
M121506-C	6	55	20.5	22	54
M121507-C	7	55	20.5	22	60
M121508-C	8	55	20.5	22	62
M121509-C	9	55	20.5	22	66
M121510-C	10	55	20.5	22	72
M121512-C	12	55	20.5	22	80
M121514-C	14	55	20.5	22	96
M121517-C	17	55	20.5	25	154
M121519-C	19	60	23	25.9	182





## HEX BIT SOCKETS

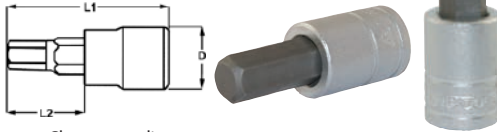

- Chrome vanadium
- S2 steel bits pressed in to the socket
- Satin finish for a better grip when handling the socket
- Ball bearing recess on the female end to grip the ratchet
- Designed for use with fastenings with a hexagon hole
- Use with in-hex screws or grub screws
- Designed and manufactured to DIN7422
- Supplied with a metal socket clip for use with a socket rail

ITEM ID:	Size	L1 mm	L2 mm	D mm	 g
M121106-C	3/16"	55	20	22	55
M121107-C	7/32"	55	20	22	55
M121108-C	1/4"	55	20	22	55
M121109-C	9/32"	55	20	22	60
M121110-C	5/16"	55	20	22	62
M121112-C	3/8"	55	20	22	67
M121116-C	1/2"	55	20	22	85
M121118-C	9/16"	55	20	22	100
M121120-C	5/8"	55	20	22	120

## LONG HEX BIT SOCKETS

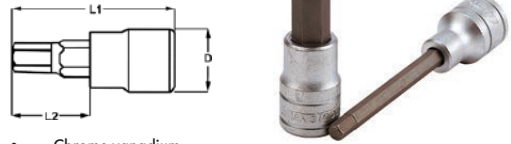

- Chrome vanadium
- S2 steel bits pressed in to the socket
- Satin finish for a better grip when handling the socket
- Ball bearing recess on the female end to grip the ratchet
- Designed for use with fastenings with a hexagon hole
- Use with in-hex screws or grub screws
- Designed and manufactured to DIN7422
- Supplied with a metal socket clip for use with a socket rail

ITEM ID:	Size mm	L1 mm	L2 mm	D mm	 g
M122505-C	5	100	65.5	22	60
M122506-C	6	100	65.5	22	60
M122506A-C	6	115	80	22	100
M122507-C	7	100	65.5	22	80
M122508-C	8	100	65.5	22	80
M122508A-C	8	115	80	22	120
M122510-C	10	100	65.5	22	100
M122510L-C	10	175	140	22	150
M122512-C	12	100	65.5	22	120
M122514-C	14	100	65.5	22	153
M122517-C	17	100	65.5	25	225



**TX BIT SOCKETS**

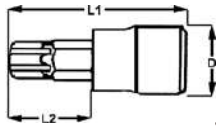

- Chrome vanadium
- S2 steel bits pressed in to the socket
- Satin finish for a better grip when handling the socket
- Ball bearing recess on the female end to grip the ratchet
- Designed for use with fastenings with a TX hole
- Supplied with a metal socket clip for use with a socket rail

ITEM ID:	Size	L1 mm	L2 mm	D mm	g
M121220T-C	TX20	55	20.5	22	64
M121225T-C	TX25	55	20.5	22	64
M121227T-C	TX27	55	20.5	22	64
M121230T-C	TX30	55	20.5	22	64
M121240T-C	TX40	55	20.5	22	64
M121245T-C	TX45	55	20.5	22	74
M121250T-C	TX50	55	20.5	22	74
M121255T-C	TX55	55	20.5	22	80
M121260T-C	TX60	55	20.5	22	80

**TPX BIT SOCKETS**

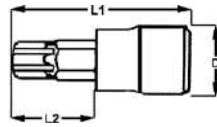

- Chrome vanadium
- S2 steel bits pressed in to the socket
- Satin finish for a better grip when handling the socket
- Ball bearing recess on the female end to grip the ratchet
- Designed for use with fastenings with a TX hole with a security pin
- Supplied with a metal socket clip for use with a socket rail

ITEM ID:	Size	L1 mm	L2 mm	D mm	g
M121220-C	TPX20	55	20.5	22	64
M121225-C	TPX25	55	20.5	22	64
M121227-C	TPX27	55	20.5	22	64
M121230-C	TPX30	55	20.5	22	64
M121240-C	TPX40	55	20.5	22	64
M121245-C	TPX45	55	20.5	22	74
M121250-C	TPX50	55	20.5	22	74
M121255-C	TPX55	55	20.5	22	80
M121260-C	TPX60	55	20.5	22	80

**LONG TX BIT SOCKETS**

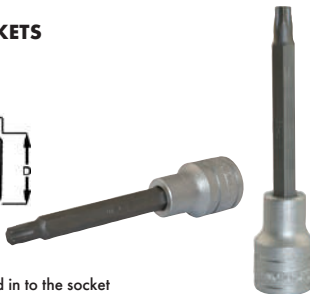
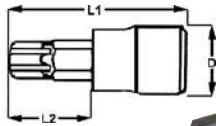

- Chrome vanadium
- S2 steel bits pressed in to the socket
- Satin finish for a better grip when handling the socket
- Ball bearing recess on the female end to grip the ratchet
- Designed for use with fastenings with a TX hole
- Supplied with a metal socket clip for use with a socket rail

ITEM ID:	Size	L1 mm	L2 mm	D mm	g
M122220T-C	TX20	100	65.5	22	82
M122225T-C	TX25	100	65.5	22	82
M122227T-C	TX27	100	65.5	22	82
M122230T-C	TX30	100	65.5	22	82
M122240T-C	TX40	100	65.5	22	85
M122245T-C	TX45	100	65.5	22	85
M122250T-C	TX50	100	65.5	22	100
M122255T-C	TX55	100	65.5	22	105
M122260T-C	TX60	100	65.5	22	135
M122270T-C	TX70	100	65.5	22	135

**RIBE BIT SOCKETS**

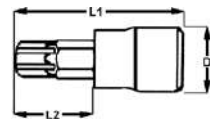

- Chrome vanadium
- S2 steel bits pressed in to the socket
- Satin finish for a better grip when handling the socket
- Ball bearing recess on the female end to grip the ratchet
- Designed for use with fastenings with a multi spline Ribe type hole
- Supplied with a metal socket clip for use with a socket rail

ITEM ID:	Size	L1 mm	L2 mm	D mm	g
M122704-C	04	100	65	22	70
M122705-C	05	100	65	22	70
M122706-C	06	100	65	22	70
M122708-C	08	100	65	22	70
M122709-C	09	100	65	22	70
M122710-C	10	100	65	22	90
M122711-C	11	100	65	22	100
M122712-C	12	100	65	22	110
M122713-C	13	100	65	22	120



## XZN BIT SOCKETS

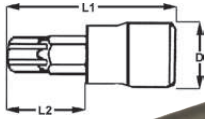

- Chrome vanadium
- S2 steel bits pressed in to the socket
- Satin finish for a better grip when handling the socket
- Ball bearing recess on the female end to grip the ratchet
- Designed for use with fastenings with a multi point XZN type hole
- Supplied with a metal socket clip for use with a socket rail

ITEM ID:	Size	L1 mm	L2 mm	D mm	 g
M122805-C	05	100	65	22	70
M122806-C	06	100	65	22	70
M122808-C	08	100	65	22	70
M122809-C	09	100	65	22	70
M122810-C	10	100	65	22	90
M122812-C	12	100	65	22	110
M122814-C	14	100	65	22	130
M122816-C	16	100	65	22	160

3/4" DRIVE

## REGULAR METRIC SOCKETS

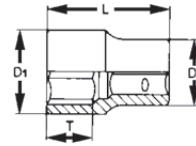

- 6 point single hexagon socket for a better grip
- Chrome vanadium
- Satin finish for a better grip when handling the socket
- Ball bearing recess on the female end to grip the ratchet
- Designed and manufactured to DIN3120/3124 and ISO2725
- Supplied with a metal socket clip for use with a socket rail

ITEM ID:	Size mm	L mm	Tmin mm	D1 mm	D2 mm	 g
M3405196-C	19	50	14	29.2	33	180
M3405216-C	21	50	14	31.2	33	180
M3405226-C	22	50	14	32.2	36	220
M3405246-C	24	51	16	34.2	36	230
M3405266-C	26	52	18	36	36	240
M3405276-C	27	52	22	38	36	240
M3405306-C	30	54	24	42	38	260
M3405326-C	32	56	26	44	38	310
M3405336-C	33	56	26	46	38	330
M3405346-C	34	56	26	47	38	350
M3405366-C	36	58	28	50	38	430
M3405386-C	38	60	28	52	42	500
M3405416-C	41	64	30	56	45	570
M3405466-C	46	68	34	62	45	690
M3405506-C	50	72	36	68	48	830

**REGULAR AF SOCKETS**

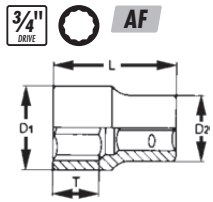

- 12 point bi-hexagon socket for easier alignment
- Chrome vanadium
- Satin finish for a better grip when handling the socket
- Ball bearing recess on the female end to grip the ratchet
- Designed and manufactured to DIN3120/3124 and ISO2725
- Supplied with a metal socket clip for use with a socket rail

ITEM ID:	Size mm	L mm	Tmin mm	D1 mm	D2 mm	g
M340124-C	3/4"	50	14	29.2	33	180
M340128-C	7/8"	51	18.1	32.2	36.2	195
M340130-C	15/16"	51	18.1	34.5	36.2	200
M340132-C	1"	51	24	37	37	200
M340134-C	1-1/16"	51	24	38.3	37	200
M340136-C	1-1/8"	51	24.3	40	38.5	230
M340138-C	1-3/16"	53	25.2	42	38.5	255
M340140-C	1-1/4"	55	28	44	38.5	275
M340142-C	1-5/16"	55	28	46	38.5	300
M340144-C	1-3/8"	57	29.7	48	42.3	360
M340146-C	1-7/16"	57	29.7	50	42.3	380
M340148-C	1-1/2"	60	31.1	52.1	45.2	440
M340152-C	1-5/8"	63	33.7	56.1	45.2	515
M340156-C	1-3/4"	65	33.7	60	48	610
M340158-C	1-13/16"	67	35.7	62	48	635
M340160-C	1-7/8"	69	37.2	64	48.3	690
M340164-C	2"	71	38.6	68.2	48.3	755

**HEX BIT SOCKETS**

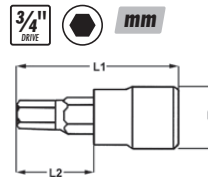

- Chrome vanadium
- S2 steel bits pressed in to the socket
- Satin finish for a better grip when handling the socket
- Ball bearing recess on the female end to grip the ratchet
- Designed for use with fastenings with a hexagon hole
- Use with in-hex screws or grub screws
- Supplied with a metal socket clip for use with a socket rail

ITEM ID:	Size mm	L1 mm	L2 mm	D mm	g
M341514-C	14	78.5	25	36	326
M341517-C	17	78.5	25	36	330
M341519-C	19	78.5	25	36	334
M341522-C	22	78.5	25	36	338

**1" DRIVE**

**REGULAR METRIC SOCKETS**

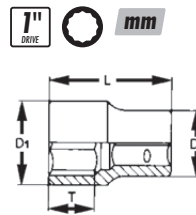

- 12 point bi-hexagon socket for easier alignment
- Chrome vanadium
- Satin finish for a better grip when handling the socket
- Ball bearing recess on the female end to grip the ratchet
- Designed and manufactured to DIN3120/3124 and ISO2725

ITEM ID:	Size mm	L mm	Tmin mm	D1 mm	D2 mm	g
M110536	36	65.3	31.2	51	45.2	440
M110541	41	70.2	33.8	57.1	45.2	550
M110546	46	74.5	37.5	64.6	49.4	810
M110550	50	75.3	38.1	69.9	55.2	995
M110555	55	80	40	76.2	57.3	1160
M110558	58	80	40	79.2	57.3	1250
M110560	60	84	41	82.1	57.3	1410
M110565	65	87.3	46.2	88	57.3	1540
M110570	70	93.4	51.5	94	68.1	2020
M110575	75	96.1	51.5	94	68.1	2020
M110580	80	103.6	55.3	105	68.1	2500

# IMPACT SOCKETS

QUALITY CONSTRUCTION, **MAXIMUM EFFICIENCY**

Impact tools use air or electricity rather than using human strength to turn a socket. When in use they are slammed into the anvil at a high rate of speed, providing a significant mechanical advantage when trying to turn a bolt. The repeated impact, combined with the torque applied to the socket, requires a different approach in the construction of the tool.

Rather than chrome vanadium impact sockets are made from chrome molybdenum, which is then carbonized, giving them a flat black look. Molybdenum as a metal is more capable of absorbing vibration than vanadium.



You'll also find a hole in the socket to use with a locking pin that keeps it from vibrating off of the tool while it's in use

All sockets are marked with the size for quick identification





**IMPACT**



Made from chrome-molybdenum according to GGG-W-6608 to guarantee quality



TengTools impact sockets are manufactured to accordance to either ANSI specifications as set out by the American National Standards Institute, or to meet DIN specifications as set out by the Deutsches Institut für Normung (German Institute for Standardization).

DIN specification impact sockets are for use with a ring and a pin to secure them to the impact tool while ANSI specification sockets contain a ball bearing that secures them to the impact tool.



*DIN Standard sockets require a retaining ring and pin to safely secure the socket to the impact tool*

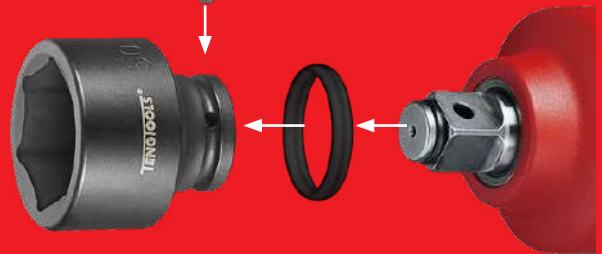

Full range of accessories including extension bars, adapter drives & universal joints





1/4" DRIVE



## REGULAR 6 POINT IMPACT SOCKETS

1/4" DRIVE mm

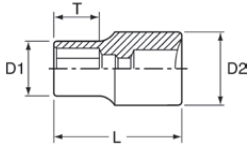

- ANSI standard design with a ball bearing socket retainer
- Chrome molybdenum for use with power tools
- Black phosphate finish for easy identification as an impact socket accessory
- Designed and manufactured to DIN3129

ITEM ID:	Size mm	L mm	T mm	D1 mm	D2 mm	g
960506-C	6	21.2	10	9.5	12	20
960507-C	7	21.2	11	11	12	20
960508-C	8	21.2	11	12	12	20
960510-C	10	21.2	12.5	14	12	20
960513-C	13	21.2	12	18	12	20

3/8" DRIVE



## REGULAR 6 POINT IMPACT SOCKETS

3/8" DRIVE mm

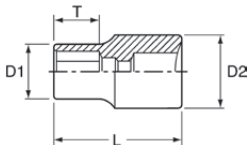

- ANSI standard design with a ball bearing socket retainer
- Chrome molybdenum for use with power tools
- Black phosphate finish for easy identification as an impact socket accessory

ITEM ID:	Size mm	L mm	T mm	D1 mm	D2 mm	g
980508-C	8	30	8	12.5	19	33
980510-C	10	30	8	15	19	34
980511-C	11	30	9	17	19	37
980512-C	12	30	9	19	19	40
980513-C	13	30	9	19	19	41
980514-C	14	30	9	20	20	41
980515-C	15	30	11	22	22	64
980516-C	16	30	11	24	24	64
980517-C	17	30	11	24	24	64
980519-C	19	30	11	26	26	72

## DEEP 6 POINT IMPACT SOCKETS

3/8" DRIVE mm

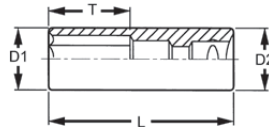

- ANSI standard design with a ball bearing socket retainer
- Chrome molybdenum for use with power tools
- Black phosphate finish for easy identification as an impact socket accessory

ITEM ID:	Size mm	L mm	T mm	D1 mm	D2 mm	g
980608-C	8	65	12.8	12.6	19	95
980610-C	10	65	26	15.2	19	89
980611-C	11	65	27	17	19	87
980612-C	12	65	27	19	19	85
980613-C	13	65	27	19	19	80
980614-C	14	65	27	20	20	87
980616-C	16	65	27	24	24	144
980617-C	17	65	27	24	24	130
980619-C	19	65	27	26	26	143

**HEX BIT IMPACT SOCKETS**

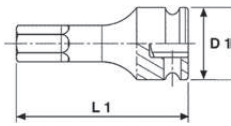

- DIN standard design for use with a retaining pin and ring
- Chrome molybdenum for use with power tools
- Black phosphate finish for easy identification as an impact socket accessory
- Ring and pin fixing hole on the female end to secure the socket
- Designed for use with fastenings with a hexagon hole
- Use with in-hex screws or grub screws
- Supplied with a metal socket clip for use with a socket rail

ITEM ID:	Size mm	L mm	D1 mm	 g	Retaining Ring	Retaining Pin
981504-C	4	52	20.8	55	0935202	P90320
981505-C	5	52	20.8	57	0935202	P90320
981506-C	6	52	20.8	60	0935202	P90320
981507-C	7	52	20.8	63	0935202	P90320
981508-C	8	52	20.8	67	0935202	P90320
981510-C	10	52	20.8	74	0935202	P90320
981512-C	12	52	20.8	85	0935202	P90320



**REGULAR 6 POINT IMPACT SOCKETS**

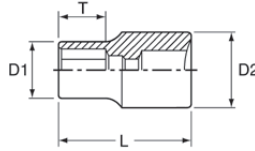

- DIN standard design for use with a retaining pin and ring
- Chrome molybdenum for use with power tools
- Black phosphate finish for easy identification as an impact socket accessory
- Ring and pin fixing hole on the female end to secure the socket
- Designed and manufactured to DIN3129

ITEM ID:	Size mm	L mm	T <sub>(min)</sub> mm	D1 mm	D2 mm	Retaining Ring	Retaining Pin
920508N	8	38	5	15	25	092194	P92320
920510N	10	38	6	17	25	092194	P92320
920511N	11	38	7	18.5	25	092194	P92320
920512N	12	38	8	20	25	092194	P92320
920513N	13	38	8	21	25	092194	P92320
920514N	14	38	10	22.5	25	092194	P92320
920515N	15	38	10	23	30	092194	P92325
920516N	16	38	10	25	30	092244	P92325
920517N1	17	38	10	26	30	092244	P92325
920518N	18	38	12	27.5	30	092244	P92325
920519N1	19	38	12	28.5	30	092244	P92325
920520N	20	38	12	30	30	092244	P92325
920521N1	21	38	12	31	30	092244	P92325
920522N	22	38	14	32.5	30	092244	P92325
920523N	23	38	16	34	30	092244	P92325
920524N	24	38	16	35	30	092244	P92325
920525N	25	45	18	36	30	092244	P92325
920526N	26	45	18	37.5	30	092244	P92325
920527N	27	45	18	38.5	30	092244	P92325
920528N	28	47	20	40	30	092244	P92325
920529N	29	47	20	41	30	092244	P92325
920530N	30	50	20	42	30	092244	P92325
920532N	32	50	22	44	30	092244	P92325



## REGULAR 6 POINT IMPACT SOCKETS

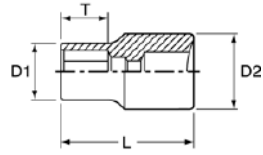

- ANSI standard design with a ball bearing socket retainer
- Chrome molybdenum for use with power tools
- Black phosphate finish for easy identification as an impact socket accessory

ITEM ID:	Size mm	L mm	T <sub>(min)</sub> mm	D1 mm	D2 mm
920510AN	10	38	4.6	17	22
920511AN	11	38	5.5	17	22
920512AN	12	38	6.1	19	22
920513AN	13	38	6.8	20	24
920514AN	14	38	8.4	21	24
920515AN	15	38	8.4	23	25
920516AN	16	38	9.5	25	25
920517AN	17	38	9.5	26	26
920518AN	18	38	10.2	28	26
920519AN	19	38	11.1	28	28
920521AN	21	38	11.7	30	30
920522AN	22	38	12.5	32	32
920524AN	24	38	13.9	36	36

## REGULAR 6 POINT IMPACT SOCKETS

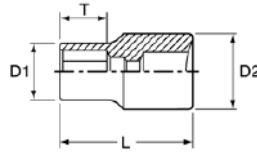

- DIN standard design for use with a retaining pin and ring
- Chrome molybdenum for use with power tools
- Black phosphate finish for easy identification as an impact socket accessory
- Ring and pin fixing hole on the female end to secure the socket
- Supplied with a metal socket clip for use with a socket rail

ITEM ID:	Size	L mm	T <sub>(min)</sub> mm	D1 mm	D2 mm	Retaining Ring	Retaining Pin
920112	3/8"	38	3.9	16.1	24	092194	P92320
920114	7/16"	38	5.5	17.8	24	092194	P92320
920116	1/2"	38	6.7	19.9	24	092194	P92320
920118	9/16"	38	8.3	21.9	24	092194	P92320
920120	5/8"	38	9.5	24	24	092244	P92325
920122	11/16"	38	9.5	26	26	092244	P92325
920124	3/4"	38	11.1	28	28	092244	P92325
920126	13/16"	38	11.5	30	30	092244	P92325
920128	7/8"	38	12.7	32	30	092244	P92325
920130	15/16"	38	12.7	33.9	30	092244	P92325
920132	1"	40	13.8	35.6	30	092244	P92325
920134	1-1/16"	42	15.8	37.6	30	092244	P92325
920136	1-1/8"	42	16.6	39.8	30	092244	P92325
920140	1-1/4"	44	16.6	44	30	092244	P92325

**STUBBY 6 POINT IMPACT SOCKET**

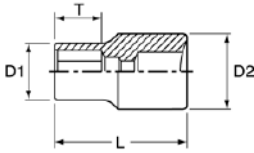

- Short reach for use in confined spaces
- DIN standard design for use with a retaining pin and ring
- Chrome molybdenum for use with power tools
- Black phosphate finish for easy identification as an impact socket accessory
- Ring and pin fixing hole on the female end to secure the socket
- Designed and manufactured to DIN3129

ITEM ID:	Size mm	L mm	T <sub>(min)</sub> mm	D1 mm	D2 mm	Retaining Ring	Retaining Pin
920710-C	10	28	5	18	24	0935202	P90320
920712-C	12	28	5	20	24	0935202	P90320
920713-C	13	28	5	20	24	0935202	P90320
920714-C	14	28	5	22	24	0935202	P90320
920715-C	15	28	5	24	24	0935202	P90320
920716-C	16	28	5	24	24	0935202	P90320
920717-C	17	28	10	26	26	093525	P90320
920718-C	18	28	10	28	28	093525	P90320
920719-C	19	28	10	28	28	093525	P90320
920721-C	21	28	10	30	30	093525	P90324
920722-C	22	28	10	32	30	093525	P90324
920724-C	24	28	10	34	30	093525	P90324

**DEEP 6 POINT IMPACT SOCKETS**

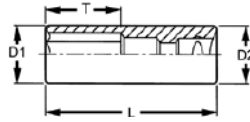

- DIN standard design for use with a retaining pin and ring
- Chrome molybdenum for use with power tools
- Black phosphate finish for easy identification as an impact socket accessory
- Ring and pin fixing hole on the female end to secure the socket
- Designed and manufactured to DIN3129

ITEM ID:	Size mm	L mm	T <sub>(min)</sub> mm	D1 mm	D2 mm	Retaining Ring	Retaining Pin
920610N	10	80	9	17	25	092194	P92320
920611N	11	80	10.5	18.5	25	092194	P92320
920612N	12	80	12	20	25	092194	P92320
920613N	13	80	12	21	25	092194	P92320
920614N	14	80	15	22.5	25	092194	P92320
920615N	15	80	15	23	30	092244	P92325
920616N	16	80	15	25	30	092244	P92325
920617N	17	80	15	26	30	092244	P92325
920618N	18	80	18	27.5	30	092244	P92325
920619N	19	80	18	28.5	30	092244	P92325
920620N	20	80	18	30	30	092244	P92325
920621N	21	80	18	31	30	092244	P92325
920622N	22	80	21	32.5	30	092244	P92325
920623N	23	80	24	34	30	092244	P92325
920624N	24	80	24	35	30	092244	P92325
920627N	27	80	27	38.5	30	092244	P92325
920628N	28	80	30	40	30	092244	P92325
920629N	29	80	30	40	30	092244	P92325
920630N	30	80	30	42	30	092244	P92325
920632N	32	80	33	44	30	092244	P92325
920635N	35	80	33	48	30	092244	P92325
920636N	36	80	33	50	30	092244	P92325







## DEEP 6 POINT IMPACT SOCKETS

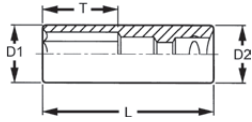

- ANSI standard design with a ball bearing socket retainer
- Chrome molybdenum for use with power tools
- Black phosphate finish for easy identification as an impact socket accessory

ITEM ID:	Size mm	L mm	T <sub>(min)</sub> mm	D1 mm	D2 mm
920610AN	10	78	4.6	17	22
920611AN	11	78	5.5	18	22
920612AN	12	78	6.1	19	22
920613AN	13	78	6.8	22	24
920614AN	14	78	8.4	22	24
920615AN	15	78	8.4	24	24
920616AN	16	78	9.5	24	24
920617AN	17	78	9.5	26	26
920618AN	18	78	10.2	28	28
920619AN	19	78	11.1	28	28
920621AN	21	78	11.7	30	30
920622AN	22	78	12.5	32	32
920624AN	24	78	13.9	35.8	35.8

## DEEP 6 POINT IMPACT SOCKETS

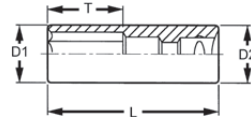

- DIN standard design for use with a retaining pin and ring
- Chrome molybdenum for use with power tools
- Black phosphate finish for easy identification as an impact socket accessory
- Ring and pin fixing hole on the female end to secure the socket
- Supplied with a metal socket clip for use with a socket rail

ITEM ID:	Size	L mm	T <sub>(min)</sub> mm	D1 mm	D2 mm	Retaining Ring	Retaining Pin
920212	3/8"	78	3.9	16	24	O92194	P92320
920214	7/16"	78	5.5	18	24	O92194	P92320
920216	1/2"	78	6.7	20.4	24	O92194	P92320
920218	9/16"	78	8.3	22	24	O92194	P92320
920220	5/8"	78	9.5	24	24	O92244	P92325
920222	11/16"	78	9.5	26	26	O92244	P92325
920224	3/4"	78	11.1	28	28	O92244	P92325
920226	13/16"	78	11.5	30	30	O92244	P92325
920228	7/8"	78	12.7	32	30	O92244	P92325
920230	15/16"	78	12.7	34	30	O92244	P92325
920232	1"	78	13.8	36	30	O92244	P92325
920234	1-1/16"	78	15.8	38	30	O92244	P92325
920236	1-1/8"	78	16.6	40	30	O92244	P92325
920240	1-1/4"	78	16.6	44.4	30	O92244	P92325
920242	1-5/16"	80	16.6	46	30	O92244	P92325
920248	1-1/2"	80	16.6	52	30	O92244	P92325



**HEX BIT IMPACT SOCKETS**

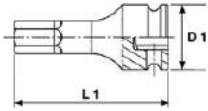

- DIN standard design for use with a retaining pin and ring
- Chrome molybdenum for use with power tools
- Black phosphate finish for easy identification as an impact socket accessory
- Ring and pin fixing hole on the female end to secure the socket
- Designed for use with fastenings with a hexagon hole
- Use with in-hex screws or grub screws
- Supplied with a metal socket clip for use with a socket rail

ITEM ID:	Size mm	L mm	D1 mm	 g	Retaining Ring	Retaining Pin
921505-C	5	78	25	81	0935202	P90320
921506-C	6	78	25	86	0935202	P90320
921508-C	8	78	25	100	0935202	P90320
921510-C	10	78	25	114	0935202	P90320
921512-C	12	78	25	132	0935202	P90320
921514-C	14	78	25	155	0935202	P90320
921517-C	17	78	25	191	0935202	P90320
921519-C	19	78	25	216	0935202	P90320

**HEX BIT IMPACT SOCKETS**

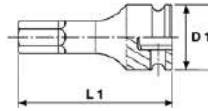

- DIN standard design for use with a retaining pin and ring
- Chrome molybdenum for use with power tools
- Black phosphate finish for easy identification as an impact socket accessory
- Ring and pin fixing hole on the female end to secure the socket
- Designed for use with fastenings with a hexagon hole
- Use with in-hex screws or grub screws
- Supplied with a metal socket clip for use with a socket rail

ITEM ID:	Size mm	L mm	D1 mm	Retaining Ring	Retaining Pin
921606	3/16"	78	24.8	092194	P92320
921608	1/4"	78	24.8	092194	P92320
921610	5/16"	78	24.8	092194	P92320
921612	3/8"	78	24.8	092194	P92320
921614	7/16"	78	24.8	092244	P92325
921616	1/2"	78	24.8	092244	P92325
921618	9/16"	78	24.8	092244	P92325
921620	5/8"	78	24.8	092244	P92325
921622	11/16"	78	24.8	092244	P92325
921624	3/4"	78	24.8	092244	P92325





## TX BIT IMPACT SOCKETS

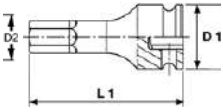

- DIN standard design for use with a retaining pin and ring
- Chrome molybdenum for use with power tools
- Black phosphate finish for easy identification as an impact socket accessory
- Ring and pin fixing hole on the female end to secure the socket
- Designed for use with fastenings with a TX hole
- Supplied with a metal socket clip for use with a socket rail

ITEM ID:	Size	L mm	D1 mm	D2 mm	g	Retaining Ring	Retaining Pin
921210TX-C	TX10	78	25	6.5	73	0935202	P90320
921215TX-C	TX15	78	25	6.5	74	0935202	P90320
921220TX-C	TX20	78	25	6.5	74	0935202	P90320
921225TX-C	TX25	78	25	6.5	74	0935202	P90320
921227TX-C	TX27	78	25	6.5	78	0935202	P93020
921230TX-C	TX30	78	25	6.5	79	093525	P90324
921240TX-C	TX40	78	25	8	86	093525	P90324
921245TX-C	TX45	78	25	9	93	093525	P90324
921250TX-C	TX50	78	25	10	98	093525	P90324
921255TX-C	TX55	78	25	12	109	093525	P90324
921260TX-C	TX60	78	25	14	122	093525	P93024
921270TX-C	TX70	78	25	16	148	093525	P90324

## XZN BIT IMPACT SOCKETS

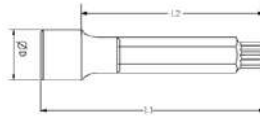

- DIN standard design for use with a retaining pin and ring
- Chrome molybdenum for use with power tools
- Black phosphate finish for easy identification as an impact socket accessory
- Ring and pin fixing hole on the female end to secure the socket
- Designed for use with fastenings with a multi point XZN type hole
- Supplied with a metal socket clip for use with a socket rail

ITEM ID:	Size	L mm	L2 mm	D mm	g
921814	14	43	23	25	73
921816	16	43	23	25	77
921817	17	43	23	25	90
921818	18	43	23	25	90
923814	14	78	53	25	127
923816	16	78	53	25	134
923817	17	78	53	25	150
923818	18	78	53	25	151

## TORQUE STICKS



- Designed for tightening wheel nuts to a pre-set torque using an air gun
- The bar absorbs the excess power of the gun once the torque is reached
- Ensures uniform tightening of the wheel nuts
- Supplied with a metal socket clip for use with a socket rail

ITEM ID:	Drive	Torque Nm	Length mm	Retaining Ring	Retaining Pin
923090	1/2"	90	200	0935202	P90320
923110	1/2"	110	200	0935202	P90320
923120	1/2"	120	200	0935202	P90320
923140	1/2"	140	200	0935202	P90320



**REGULAR 6 POINT IMPACT SOCKETS**

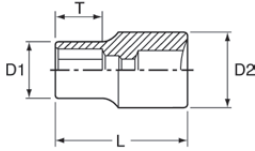

- DIN standard design for use with a retaining pin and ring
- Chrome molybdenum for use with power tools
- Black phosphate finish for easy identification as an impact socket accessory
- Ring and pin fixing hole on the female end to secure the socket

ITEM ID:	Size mm	L mm	T <sub>(min)</sub> mm	D1 mm	D2 mm	g	Retaining Ring	Retaining Pin
940519-C	19	50	13	33	44	247	095036	P90435
940521-C	21	50	15	35	44	250	095036	P90435
940522-C	22	50	15	37	44	252	095036	P90435
940523-C	23	50	16	38	44	252	095036	P90435
940524-C	24	50	16	39	44	255	095036	P90435
940527-C	27	54	19	43	44	270	095036	P90435
940528-C	28	54	19	44	44	300	095036	P90435
940530-C	30	54	21	47	44	330	095036	P90435
940532-C	32	56	22	48	44	330	095036	P90435
940533-C	33	56	22	51	44	395	095036	P90435
940534-C	34	56	22	52	44	420	095036	P90435
940536-C	36	56	25	54	44	455	095036	P90435
940538-C	38	58	25	57	44	465	095036	P90435
940540-C	40	58	25	58	44	530	095036	P90435
940541-C	41	58	27	60	44	610	095036	P90435
940546-C	46	63	30	67	44	775	095036	P90435
940550-C	50	68	30	71	44	839	095036	P90435

**REGULAR 6 POINT IMPACT SOCKETS**

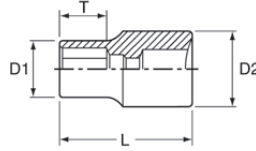

- 3/4" drive regular 6 point AF impact socket
- DIN standard design for use with a retaining pin and ring
- Chrome molybdenum for use with power tools
- Black phosphate finish for easy identification as an impact socket accessory
- Ring and pin fixing hole on the female end to secure the socket to the air gun
- Supplied with a metal socket clip for use with a socket rail

ITEM ID:	Size mm	L mm	T <sub>(min)</sub> mm	D1 mm	D2 mm	Retaining Ring	Retaining Pin
940122	11/16"	51	14	29.5	41.4	095036	P90435
940124	3/4"	51	14	32	41.4	095036	P90435
940126	13/16"	51	14	35	41.4	095036	P90435
940128	7/8"	51	14	36	41.4	095036	P90435
940130	15/16"	51	16.5	38.5	41.4	095036	P90435
940132	1"	53	16.5	40	41.4	095036	P90435
940134	1-1/16"	53	20	42.5	44	095036	P90435
940136	1-1/8"	53	20	44	44	095036	P90435
940138	1-3/16"	53	20	46	44	095036	P90435
940140	1-1/4"	57	21	48.5	44	095036	P90435
940142	1-5/16"	57	21	50	44	095036	P90435
940144	1-3/8"	57	21	52.5	44	095036	P90435
940146	1-7/16"	57	21	53.5	44	095036	P90435
940148	1-1/2"	57	22	56	44	095036	P90435
940150	1-9/16"	58	22	58.5	44	095036	P90435
940152	1-5/8"	58	22	60	44	095036	P90435
940154	1-11/16"	62	25	63.5	44	095036	P90435
940156	1-3/4"	62	25	64.5	44	095036	P90435
940160	1-7/8"	68	30	68	44	095036	P90435
940162	1-15/16"	68	30	70	44	095036	P90435
940164	2"	68	30	71	44	095036	P90435
940166	2-1/16"	71	32	73	54	095036	P90435
940168	2-1/8"	71	32	75.5	54	095036	P90435
940170	2-3/16"	71	32	77.5	54	095036	P90435
940172	2-1/4"	73	34	80	54	095036	P90435
940174	2-5/16"	73	34	81	54	095036	P90435
940176	2-3/8"	73	34	83	54	095036	P90435





## DEEP 6 POINT IMPACT SOCKETS

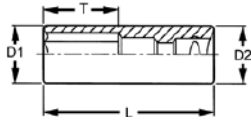

- 3/4" drive deep 6 point impact socket
- DIN standard design for use with a retaining pin and ring
- Chrome molybdenum for use with power tools
- Black phosphate finish for easy identification as an impact socket accessory
- Ring and pin fixing hole on the female end to secure the socket to the air gun

ITEM ID:	Size mm	L mm	T <sub>(min)</sub> mm	D1 mm	D2 mm	g	Retaining Ring	Retaining Pin
940619-C	19	95	31	33	44	595	095036	P90435
940621-C	21	95	31	35	44	610	095036	P90435
940622-C	22	95	31	37	44	620	095036	P90435
940623-C	23	95	31	38	44	630	095036	P90435
940624-C	24	95	31	39	44	640	095036	P90435
940627-C	27	95	31	43	44	680	095036	P90435
940630-C	30	95	33	47	44	720	095036	P90435
940632-C	32	95	33	49	44	870	095036	P90435
940633-C	33	95	34	51	44	860	095036	P90435
940634-C	34	95	34	52	44	810	095036	P90435
940636-C	36	95	36	54	44	830	095036	P90435
940638-C	38	95	36	57	44	920	095036	P90435
940641-C	41	95	36	58	44	790	095036	P90435
940646-C	46	95	36	67	44	900	095036	P90435
940650-C	50	95	36	71	44	1227	095036	P90435

## DEEP 6 POINT IMPACT SOCKETS

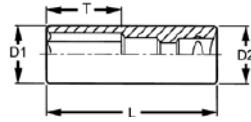

- DIN standard design for use with a retaining pin and ring
- Chrome molybdenum for use with power tools
- Black phosphate finish for easy identification as an impact socket accessory
- Ring and pin fixing hole on the female end to secure the socket
- Supplied with a metal socket clip for use with a socket rail

ITEM ID:	Size mm	L mm	T <sub>(min)</sub> mm	D1 mm	D2 mm	Retaining Ring	Retaining Pin
940224	3/4"	90	26	32	41.4	095036	P90435
940226	13/16"	90	26	35	41.4	095036	P90435
940228	7/8"	90	26	36	41.4	095036	P90435
940230	15/16"	90	26	38.5	41.4	095036	P90435
940232	1"	90	26	40	41.4	095036	P90435
940234	1-1/16"	90	28	42.5	44	095036	P90435
940236	1-1/8"	90	28	44	44	095036	P90435
940238	1-3/16"	90	28	46	44	095036	P90435
940240	1-1/4"	90	28	48.5	44	095036	P90435
940242	1-5/16"	90	30	50	44	095036	P90435
940244	1-3/8"	90	30	52.5	44	095036	P90435
940246	1-7/16"	90	30	53.5	44	095036	P90435
940248	1-1/2"	90	34	56	44	095036	P90435
940250	1-9/16"	90	34	58.5	44	095036	P90435
940252	1-5/8"	90	34	60	44	095036	P90435
940254	1-11/16"	90	34	63.5	44	095036	P90435
940256	1-3/4"	90	34	64.5	44	095036	P90435
940258	1-13/16"	90	34	66	44	095036	P90435
940260	1-7/8"	90	34	68	44	095036	P90435



**EXTRA LONG 6 POINT METRIC IMPACT SOCKET**

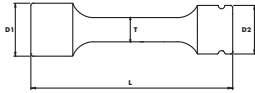

- Ideal for reaching wheel nuts on recessed truck wheels
- DIN standard design for use with a retaining pin and ring
- Chrome molybdenum for use with power tools
- Black phosphate finish for easy identification as an impact socket accessory
- Ring and pin fixing hole on the female end to secure the socket

ITEM ID:	Size mm	L mm	T <sub>(min)</sub> mm	D1 mm	D2 mm	g	Retaining Ring	Retaining Pin
940732-C	32	400	22	48	44	1850	O95036	P90435

**HEX BIT IMPACT SOCKETS**

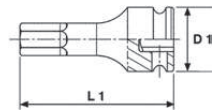

- DIN standard design for use with a retaining pin and ring
- Chrome molybdenum for use with power tools
- Black phosphate finish for easy identification as an impact socket accessory
- Ring and pin fixing hole on the female end to secure the socket
- Designed for use with fastenings with a hexagon hole
- Use with in-hex screws or grub screws
- Supplied with a metal socket clip for use with a socket rail

ITEM ID:	Size mm	L mm	D1 mm	g	Retaining Ring	Retaining Pin
941519-C	19	90	44	600	O95036	P90435
941522-C	22	90	44	600	O95036	P90435
941524-C	24	90	44	600	O95036	P90435



**REGULAR 6 POINT IMPACT SOCKETS**

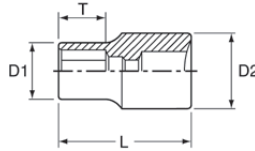

- DIN standard design for use with a retaining pin and ring
- Chrome molybdenum for use with power tools
- Black phosphate finish for easy identification as an impact socket accessory
- Ring and pin fixing hole on the female end to secure the socket

ITEM ID:	Size mm	L mm	T <sub>(min)</sub> mm	D1 mm	D2 mm	g	Retaining Ring	Retaining Pin
910524	24	58	18	41	54	640	O97045	P90545
910527	27	58	20	46	54	645	O97045	P90545
910530	30	60	21	49	54	680	O97045	P90545
910532	32	60	21	52	54	700	O97045	P90545
910533	33	60	21	53	54	700	O97045	P90545
910534	34	60	21	55	54	690	O97045	P90545
910536	36	65	30	56	54	700	O97045	P90545
910538	38	65	30	59	54	750	O97045	P90545
910541	41	67	30	63	54	850	O97045	P90545
910546	46	74	40	69	54	1005	O97045	P90545
910550	50	80	43	74	54	1220	O97045	P90545
910555	55	84	43	80	54	1470	O97045	P90545
910560	60	87	46	86	54	1610	O97045	P90545
910565	65	90	49	92	54	1890	O97045	P90545
910570	70	96	51	99	54	2355	O97045	P90545
910575	75	98	52	104	54	2455	O97051	P90551
910580	80	100	52	109	86	3750	O97051	P90551
910585	85	100	52	115	86	4750	O910075	P90675
910590	90	100	55	119	86	6000	O910075	P90675
910595	95	100	55	130	86	6500	O97045	P90545





## DEEP 6 POINT METRIC IMPACT SOCKET

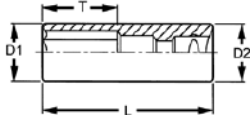

- DIN standard design for use with a retaining pin and ring
- Chrome molybdenum for use with power tools
- Black phosphate finish for easy identification as an impact socket accessory
- Ring and pin fixing hole on the female end to secure the socket

ITEM ID:	Size mm	L mm	T <sub>(min)</sub> mm	D1 mm	D2 mm	g	Retaining Ring	Retaining Pin
910627R	27	100	50	46	54	990	O97045	P90545
910630R	30	100	50	50	54	1040	O97045	P90545
910632R	32	100	50	52	54	1060	O97045	P90545
910633R	33	100	50	53	54	1070	O97045	P90545

## DEEP THINWALL METRIC IMPACT SOCKETS

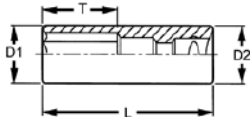

- Thin wall design for reaching in to recesses
- DIN standard design for use with a retaining pin and ring
- Chrome molybdenum for use with power tools
- Black phosphate finish for easy identification as an impact socket accessory
- Ring and pin fixing hole on the female end to secure the socket

ITEM ID:	Size mm	L mm	T <sub>(min)</sub> mm	D1 mm	D2 mm	g	Retaining Ring	Retaining Pin
910624	24	100	28	38	54	830	O97045	P90545
910627	27	100	28	43	54	895	O97045	P90545
910628	28	100	28	43	54	895	O97045	P90545
910630	30	100	42	45	54	945	O97045	P90545
910632	32	100	45	47	54	935	O97045	P90545
910633	33	100	45	49	54	980	O97045	P90545
910636	36	100	66	52	54	870	O97045	P90545

## EXTRA LONG 6 POINT METRIC IMPACT SOCKET

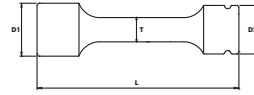

- Ideal for reaching wheel nuts on recessed truck wheels
- DIN standard design for use with a retaining pin and ring
- Chrome molybdenum for use with power tools
- Black phosphate finish for easy identification as an impact socket accessory
- Ring and pin fixing hole on the female end to secure the socket

ITEM ID:	Size mm	L mm	T <sub>(min)</sub> mm	D1 mm	D2 mm	g	Retaining Ring	Retaining Pin
910732	32	400	28	48	54	1840	O97045	P90545

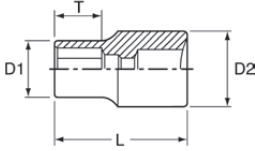
**REGULAR 6 POINT METRIC IMPACT SOCKETS**

- DIN standard design for use with a retaining pin and ring
- Chrome molybdenum for use with power tools
- Black phosphate finish for easy identification as an impact socket accessory
- Ring and pin fixing hole on the female end to secure the socket

ITEM ID:	Size mm	L mm	T <sub>(min)</sub> mm	D1 mm	D2 mm	 g	Retaining Ring	Retaining Pin
912041	41	80	27	69	86	1800	O910075	P90675
912046	46	84	29	75	86	2000	O910075	P90675
912050	50	87	30	80	86	2400	O910075	P90675
912055	55	90	32	86	86	2600	O910075	P90675
912060	60	95	35	91	86	2870	O910075	P90675
912065	65	100	38	100	86	3230	O910075	P90675
912070	70	105	40	104	86	3670	O910075	P90675
912075	75	105	42	105	86	4000	O910075	P90675
912080	80	110	46	116	86	4300	O910075	P90675
912085	85	110	46	123	86	4600	O910075	P90675
912090	90	112	48	129	86	5100	O910075	P90675
912095	95	112	48	136	127	7700	O9100115	P906110
912100	100	115	50	142	127	8200	O9100115	P906110
912105	105	120	52	148	127	8600	O9100115	P906110
912110	110	124	54	154	127	9100	O9100115	P906110
912115	115	128	56	161	127	10300	O9100115	P906110
912120	120	132	58	167	127	11500	O9100115	P906110
912125	125	136	60	173	127	12500	O9100115	P906110
912130	130	140	60	180	127	13500	O9100115	P906110



# TORQUE TOOLS

## MAKE THE PROFESSIONAL CHOICE

Teng Tools torque wrenches have become an industry standard. Whether you choose the classic version that has been a favourite for many years or the new P-Series range designed for the industrial and maintenance sectors you are guaranteed quality, accuracy and reliability as standard.

### Red Line Torque Wrenches

Click type mechanism to signal when the required torque is reached

Reversible 24 teeth ratchet mechanism in according to DIN3122 giving 15° increments

Equipped with an in-built angular gauge for when tightening at specific angle is required

Switch for changing between left and right-hand action. Designed to torque right hand only. Bi-Directional models are available.

Accurate to +/- 4% and conforms to ISO6789



Scale in Nm & ft/lb

Twist locking to ensure the set torque is maintained





## DOs



### Use carefully

Torque wrenches are a measuring instrument and need to be treated with care

### Reset torque

After use set the torque to its lowest setting. If you don't over time the springs inside the wrench can lose their normal tension

### Store safely

All torque instruments should be stored in their original case

### Keep wrench maintained

Torque wrenches should be cleaned and calibrated on a yearly basis



**All torque wrenches are supplied with a factory calibration certificate**

## DONT's



### Use as a power bar

Torque wrenches should never be used as a power bar to shift stubborn fastenings

### Abuse your wrench

Do not drop your torque wrench or overload the wrench with a pipe extension

### Store in conditions that lead to corrosion

Avoid any storage locations that are subject to high or low temperatures and high humidity

### Use without PPE

We recommend safety glasses when using any torque wrench or torque product

## P-SERIES Torque Wrenches

Compact head for easier use in confined spaces

Quick release 72 teeth ratchet mechanism with twist reverse manufactured to DIN3122

Click type mechanism to signal when the required torque is reached

Industrial quality grade steel tube for added stability

Designed to torque right hand only

Ergonomic bi-material grip for maximum comfort when in use

Easy to read Nm scale that is simple to adjust

Locking button to ensure the set torque is securely maintained

Hanging facility which can be used together with a fall protection equipment







**1/4"**  
DRIVE

## NEW TORQUE SCREWDRIVER

**1/4"**  
DRIVE

- Slipper mechanism ensures that no torque is applied beyond the set torque
- Simple to adjust and easy to read Nm scale
- Push locking facility to ensure the set torque is maintained
- Accurate to +/- 6% and conforms to ISO6789 for assured accuracy
- Each torque wrench has its own individual certification number
- Supplied in a handy storage case



ITEM ID:	Calibration Cert		Range Nm
	Factory	New	
1492TSD	Y	-	1-5

**NEW**



Get organised!

Tray Size
TEA

**1/4"**  
DRIVE

**38**  
Pieces

## TORQUE SCREWDRIVER SET

- 1-5 Nm torque screwdriver with accessories
- Supplied in the unique TengTools single TC tray
- Tools are held in place using three colour pre-cut EVA foam clearly showing where each tool belongs

1-5Nm Torque screwdriver, 1/4"Mx1/4"Hex adaptor

1/4" Hex bits: Length 25mm	⊖ 3, 4.5, 5.5, 6.5	⊕ PH0, PH1, PH2, PH3	⊕ PH2G
	⊗ 2, 3, 4, 5, 6	⊕ PZ0, PZ1, PZ2, PZ3	⊕ ROB1, 2, 3
	⊕ TX9, TX10, TX15, TX20, TX25, TX27, TX30, TX40		
	⊕ TPX10, TPX15, TPX20, TPX30, TPX40		

Item ID: TEASD38

**NEW**



Get organised!

Tray Size
TT

**1/4"**  
DRIVE

**38**  
Pieces

## TORQUE SCREWDRIVER SET

- Includes a 1-5Nm 1/4" drive torque screwdriver
- Wide range of screwdriver bits and accessories
- Removable lid and dove tail joints

1-5Nm Torque screwdriver, 1/4"Mx1/4"Hex adaptor

1/4" Hex bits: Length 25mm	⊖ 3, 4.5, 5.5, 6.5	⊕ PH0, PH1, PH2, PH3	⊕ PH2G
	⊗ 2, 3, 4, 5, 6	⊕ PZ0, PZ1, PZ2, PZ3	⊕ ROB1, 2, 3
	⊕ TX9, TX10, TX15, TX20, TX25, TX27, TX30, TX40		
	⊕ TPX10, TPX15, TPX20, TPX30, TPX40		

Item ID: TTSD38

**NEW**



Get organised!

Tray Size
TED

**95**  
Pieces

**EVA**

## TORQUE SCREWDRIVER SET

- 1-5 Nm torque screwdriver with accessories
- Ratcheting bits driver set included
- Supplied in the unique TengTools double width TC tray
- Tools are held in place using three colour pre-cut EVA foam clearly showing where each tool belongs

1/4" Drive	1-5 Nm Torque screwdriver, Quick release chuck, Sliding T-bar, 6" Flexible extension, Ratcheting bits driver with assorted bits, 1/4"M:1/4" hex adaptor		
3/8" Drive	3/8"M x 5/16" Hex adaptor		
1/2" Drive	Reversible impact driver, 5/16" Hex bit adaptor		
5/16" Hex bits: Length 36mm	⊖ 6, 8, 10, 12	⊕ TX30, TX40, TX45, TX50, TX55	
	⊗ 4, 5, 6, 8	⊕ PH1, PH2, PH3, PH4	
1/4" Hex bits: Length 25mm	⊖ 3.5, 4, 4.5, 5.5 (x2), 6.5, 8	⊕ PH1 (x3), PH2 (x6), PH3	
	⊕ PZ1 (x3), PZ2 (x6), PZ3	⊕ 2, 3, 4, 5, 6, 8	
	⊕ 1, 2, 3	⊕ PH2G (x3)	
	⊕ TX6, TX7, TX8, TX9, TX10, TX15, TX20 (x3), TX25 (x3), TX27, TX30, TX40		
	⊕ TPX10, TPX15, TPX20 (x2), TPX25 (x2), TPX27, TPX30, TPX40		

Item ID: TEDSD14

**TORQUE WRENCHES**



- Equipped with an in-built angular gauge for easier after tightening
- Click type mechanism to signal when the required torque is reached
- Additional ft/lb reference scale
- Marked to show the correct place where pressure should be applied
- Twist locking facility to ensure the set torque is maintained
- Reversible 24 teeth ratchet mechanism (DIN3122) giving 15° increments
- Designed to torque right hand (clockwise) fasteners
- Accurate to +/- 4% and conforms to ISO6789 for assured accuracy
- Each torque wrench has it's own individual certification number
- Supplied in a handy storage case



ITEM ID:	Calibration Cert		Range		Scale		L mm	W mm	H mm	Weight g
	Factory	New	Nm	ft/lb	Nm	ft/lb				
1492AG-E	Y	-	5-25	4-18	0.4	0.4	277	27.6	20.6	580
1492AG-CT	-	Y	5-25	4-18	0.4	0.4	277	27.6	20.6	580



**TORQUE WRENCHES**



- Equipped with an in-built angular gauge for easier after tightening
- Click type mechanism to signal when the required torque is reached
- Additional ft/lb reference scale
- Marked to show the correct place where pressure should be applied
- Twist locking facility to ensure the set torque is maintained
- Reversible 24 teeth ratchet mechanism (DIN3122) giving 15° increments
- Designed to torque right hand (clockwise) fasteners
- Accurate to +/- 4% and conforms to ISO6789 for assured accuracy
- Each torque wrench has it's own individual certification number
- Supplied in a handy storage case



ITEM ID:	Calibration Cert		Range		Scale		L mm	W mm	H mm	Weight g
	Factory	New	Nm	ft/lb	Nm	ft/lb				
3892AG-E1	Y	-	5-25	4-18	0.4	0.4	277	27.6	20.6	580
3892AG1-CT	-	Y	5-25	4-18	0.4	0.4	277	27.6	20.6	580
3892AG-E3	Y	-	20-110	15-75	1.0	1.0	368	35.9	27.7	580
3892AG3-CT	-	Y	20-110	15-75	1.0	1.0	368	35.9	27.7	580

**P-SERIES TORQUE WRENCHES**



- Click type mechanism to signal when the required torque is reached
- Simple to adjust and easy to read Nm scale
- Locking button to ensure the set torque is securely maintained
- Compact head for easier use in confined spaces
- Quick release 72 teeth ratchet mechanism with twist reverse (DIN3122)
- Designed to torque right hand (clockwise) fasteners
- Ergonomic bi-material grip for added comfort
- Marked to show the correct place where pressure should be applied
- Hanging facility which can be used together with a fall protection wire
- Accurate to +/- 4% and conforms to ISO6789 for assured accuracy
- Each torque wrench has it's own individual certification number
- Supplied in a handy storage case



ITEM ID:	Calibration Cert		Range		Scale Nm	L mm	W mm	H mm	Weight g
	Factory	New	Nm	ft/lb					
3892P060	Y	-	12-60	0.5	380	36	36	930	
3892P060-CT	-	Y	12-60	0.5	380	36	36	930	
3892P100	Y	-	20-100	0.5	410	36	36	960	
3892P100-CT	-	Y	20-100	0.5	410	36	36	960	

**DIGITAL BI-DIRECTIONAL TORQUE WRENCH**



- Simple to use with 9 separate torque settings
- Can be pre-programmed for different torque tolerances before use
- Audio visual warning with an indicator light to ensure the correct torque
- Easy to read digital scale showing Nm, ft/lb, in/lb or kg/m readings
- Marked to show the correct place where pressure should be applied
- Reversible 45 teeth quick release ratchet mechanism (DIN3122)
- Suitable for use on clockwise and anti-clockwise fastenings
- Accurate to +/- 1% and conforms to ISO6789 for assured accuracy
- Each torque wrench has it's own individual certification number
- Uses standard AA batteries for easy replacement
- Supplied in a handy storage case



ITEM ID:	Calibration Cert		Range		Scale		L mm	W mm	H mm	Weight g
	Factory	New	Nm	ft/lb	Nm	ft/lb				
3892D100	Y	-	10-100	7-75	0.1	0.1	457	42.5	46.5	904
3892D100-CT	-	Y	10-100	7-75	0.1	0.1	457	42.5	46.5	904



Get organised!

Tray Size	TX

## TORQUE WRENCH SET

3/8" DRIVE 22 Pieces

- Ideal set for automotive technicians
- Equipped with an in-built angular gauge for easier after tightening
- Click type mechanism when the required torque is reached
- Additional ft/lb reference scale (range 15-75 ft/lb)
- Marked to show the correct place where pressure should be applied
- Twist locking facility to ensure the set torque is maintained
- Reversible 24 teeth ratchet (DIN3122) giving 15° increments
- Designed to torque right hand (clockwise) fasteners
- Accurate to +/- 4% conforms to ISO6789 for assured accuracy
- Individually tested and certified at the time of manufacture

3/8" Drive Torque wrench (20-110Nm, 15-75 ft/lb),  
3" and 5" extension bars, adaptor for 10mm hex bits

10mm Hex Drive TX bits:

TX8, TX10, TX15, TX20, TX25, TX27, TX30, TX40

3/8" Drive Crow Foot Wrenches

10, 11, 12, 13, 14, 15, 16, 17, 18, 19 mm

Item ID: TTX3892



Get organised!

Tray Size	TEX

## TORQUE WRENCH SET

3/8" DRIVE 1/2" DRIVE 2 Pieces EVA

- Equipped with an in-built angular gauge for easier after tightening
- Click type mechanism to signal when the required torque is reached
- Additional ft/lb reference scale
- Marked to show the correct place where pressure should be applied
- Twist locking facility to ensure the set torque is maintained
- Reversible 24 teeth ratchet (DIN3122) giving 15° increments
- Designed to torque right hand (clockwise) fasteners
- Accurate to +/- 4% conforms to ISO6789 for assured accuracy
- Individually tested and certified at the time of manufacture
- Tools are held in place using three colour pre-cut EVA foam

Torque Wrenches	
3/8" Drive	20-110Nm (15-81 ft/lb)
1/2" Drive	40-210Nm (30-150 ft/lb)

Item ID: TEX1238

1/2" DRIVE

## TORQUE WRENCHES

1/2" DRIVE

- Equipped with an in-built angular gauge for easier after tightening
- Click type mechanism to signal when the required torque is reached
- Additional ft/lb reference scale
- Marked to show the correct place where pressure should be applied
- Twist locking facility to ensure the set torque is maintained
- Reversible 24 teeth ratchet mechanism (DIN3122) giving 15° increments
- Designed to torque right hand (clockwise) fasteners
- Accurate to +/- 4% and conforms to ISO6789 for assured accuracy
- Each torque wrench has it's own individual certification number
- Supplied in a handy storage case



ITEM ID:	Calibration Cert		Range		Scale		L	W	H	Weight
	Factory	New	Nm	ft/lb	Nm	ft/lb	mm	mm	mm	g
1292AG-EP	Y	-	40-210	30-150	1.0	1.0	465	46.9	33.4	1340
1292AGP-CT	-	Y	40-210	30-150	1.0	1.0	465	46.9	33.4	1340
1292AG-E4	Y	-	70-350	50-250	5.0	5.0	632	47.1	37.1	2400
1292AG4-CT	-	Y	70-350	50-250	5.0	5.0	632	47.1	37.1	2400

## BI-DIRECTIONAL TORQUE WRENCHES

1/2" DRIVE

- Equipped with an in-built angular gauge for easier after tightening
- Click type mechanism to signal when the required torque is reached
- Additional ft/lb reference scale
- Marked to show the correct place where pressure should be applied
- Twist locking facility to ensure the set torque is maintained
- Reversible 24 teeth ratchet mechanism (DIN3122) giving 15° increments
- For use with clockwise & anti-clockwise fastenings
- Switch direction by pushing through the square drive and turning the wrench over
- Accurate to +/- 4% and conforms to ISO6789 for assured accuracy
- Each torque wrench has it's own individual certification number
- Supplied in a handy storage case



ITEM ID:	Calibration Cert		Range		Scale		L	W	H	Weight
	Factory	New	Nm	ft/lb	Nm	ft/lb	mm	mm	mm	g
1292AG-ER	Y	-	40-210	30-150	1.0	1.0	465	46.9	33.4	1340
1292AGR-CT	-	Y	40-210	30-150	1.0	1.0	465	46.9	33.4	1340
1292AG-E4R	Y	-	70-350	50-250	5.0	5.0	632	47.1	37.1	2400
1292AG4R-CT	-	Y	70-350	50-250	5.0	5.0	632	47.1	37.1	2400

**P-SERIES TORQUE WRENCHES**



- Click type mechanism to signal when the required torque is reached
- Simple to adjust and easy to read Nm scale
- Locking button to ensure the set torque is securely maintained
- Compact head for easier use in confined spaces
- Quick release 72 teeth ratchet mechanism with twist reverse (DIN3122)
- Designed to torque right hand (clockwise) fasteners
- Ergonomic bi-material grip for added comfort
- Marked to show the correct place where pressure should be applied
- Hanging facility which can be used together with a fall protection wire
- Accurate to +/- 4% and conforms to ISO6789 for assured accuracy
- Each torque wrench has it's own individual certification number
- Supplied in a handy storage case



ITEM ID:	Calibration Cert		Range	Scale	L	W	H	
	Factory	New	Nm	Nm	mm	mm	mm	
1292P100	Y	-	20-100	0.5	410	36	36	965
1292P100-CT	-	Y	20-100	0.5	410	36	36	965
1292P200	Y	-	40-200	1.0	490	42	44	1465
1292P200-CT	-	Y	40-200	1.0	490	42	44	1465
1292P320	Y	-	60-320	2.0	560	42	44	1645
1292P320-CT	-	Y	60-320	2.0	560	42	44	1645

**DIGITAL BI-DIRECTIONAL TORQUE WRENCH**



- Simple to use with 9 separate torque settings
- Contains an insert head so can be used with 14x18mm insert tools
- Can be pre-programmed for different torque tolerances before use
- Audio visual warning with an indicator light to ensure the correct torque
- Easy to read digital scale showing Nm, ft/lb, in/lb or kg/m readings
- Marked to show the correct place where pressure should be applied
- Reversible 45 teeth quick release ratchet mechanism (DIN3122)
- Suitable for use on clockwise and anti-clockwise fastenings
- Accurate to +/- 1% and conforms to ISO6789 for assured accuracy
- Each torque wrench has it's own individual certification number
- Uses standard AA batteries for easy replacement
- Supplied in a handy storage case



ITEM ID:	Calibration Cert		Range	Scale	L	W	H			
	Factory	New	Nm	ft/lb	Nm	ft/lb	mm		mm	mm
1292D200	Y	-	20-200	30-150	0.1	0.1	548	42.5	46.5	1200
1292D200-CT	-	Y	20-200	30-150	0.1	0.1	548	42.5	46.5	1200

**PRE SET TORQUE WRENCHES**



- Click type mechanism to signal when the required torque is reached
- Fixed setting for consistent torque application
- Robust 24 teeth ratchet mechanism for 15° increments
- Rubber grip for added comfort particularly with repeated use
- Accurate to +/- 4% conforms to ISO6789 for assured accuracy
- Individually tested and certified at the time of manufacture
- Rack included for storing the tools on a wall or workbench panel
- Designed and manufactured to DIN and ISO standards



ITEM ID:	Calibration Cert		Preset Torque	L	W	H	
	Factory	New	Nm	mm	mm	mm	
1292AG-090	Y	-	90	513	46.9	33.4	1400
1292AG-110	Y	-	110	513	46.9	33.4	1400
1292AG-120	Y	-	120	513	46.9	33.4	1400
1292AG-140	Y	-	140	513	46.9	33.4	1400



**TORQUE WRENCH SET**



- Equipped with an in-built angular gauge for easier after tightening
- Additional ft/lb reference scale (range 30-150 ft/lb)
- Marked to show the correct place where pressure should be applied
- Twist locking facility to ensure the set torque is maintained
- Reversible 24 teeth ratchet (DIN3122) giving 15° increments
- Designed to torque right hand (clockwise) fasteners
- Accurate to +/- 4% conforms to ISO6789 for assured accuracy
- Individually tested and certified at the time of manufacture

1/2" Drive Torque wrench (40-210Nm, 30-150 ft/lb)

Item ID: **TTX1292**



**NEW**



Get organised!

Tray Size	11x

## P-SERIES TORQUE WRENCH SET

1/2" DRIVE 1 Pieces

- Click type mechanism to signal when the required torque is reached
- Simple to adjust and easy to read Nm scale
- Locking button to ensure the set torque is securely maintained
- Compact head for easier use in confined spaces
- Quick release 72 teeth ratchet mechanism with twist reverse (DIN3 122)
- Designed to torque right hand (clockwise) fasteners
- Ergonomic bi-material grip for added comfort
- Marked to show the correct place where pressure should be applied
- Hanging facility which can be used together with a fall protection wire
- Accurate to +/- 4% and conforms to ISO6789 for assured accuracy
- Each torque wrench has it's own individual certification number

1/2" Drive P-SERIES Torque wrench (40-200Nm)

Item ID: TTXP1292

3/4" DRIVE

## TORQUE WRENCHES

3/4" DRIVE

- Equipped with an in-built angular gauge for easier after tightening
- Click type mechanism to signal when the required torque is reached
- Additional ft/lb reference scale
- Marked to show the correct place where pressure should be applied
- Twist locking facility to ensure the set torque is maintained
- Reversible 24 teeth ratchet mechanism (DIN3 122) giving 15° increments
- Designed to torque right hand (clockwise) fasteners
- Accurate to +/- 4% and conforms to ISO6789 for assured accuracy
- Each torque wrench has it's own individual certification number
- Supplied in a handy storage case



ITEM ID:	Calibration Cert		Range		Scale		L mm	W mm	H mm	Weight g
	Factory	New	Nm	ft/lb	Nm	ft/lb				
3492AG-E	Y	-	65-450	48-330	5.0	5.0	850	72.5	53.5	3840
3492AG-CT	-	Y	65-450	48-330	5.0	5.0	850	72.5	53.5	3840
3492AG-E1	Y	-	140-700	100-500	2.5	2.5	1065	72.5	53.5	5970
3492AG1-CT	-	Y	140-700	100-500	2.5	2.5	1065	72.5	53.5	5970
3492AG-E2	Y	-	140-980	100-700	2.5	2.5	1213	72.5	53.5	6550
3492AG2-CT	-	Y	140-980	100-700	2.5	2.5	1213	72.5	53.5	6550

## BI-DIRECTIONAL TORQUE WRENCHES

3/4" DRIVE

- Equipped with an in-built angular gauge for easier after tightening
- Click type mechanism to signal when the required torque is reached
- Additional ft/lb reference scale
- Marked to show the correct place where pressure should be applied
- Twist locking facility to ensure the set torque is maintained
- Reversible 24 teeth ratchet mechanism (DIN3 122) giving 15° increments
- For use with clockwise & anti-clockwise fastenings
- Accurate to +/- 4% and conforms to ISO6789 for assured accuracy
- Each torque wrench has it's own individual certification number
- Supplied in a handy storage case



ITEM ID:	Calibration Cert		Range		Scale		L mm	W mm	H mm	Weight g
	Factory	New	Nm	ft/lb	Nm	ft/lb				
3492AG-ER	Y	-	65-450	48-330	5.0	5.0	850	72.5	53.5	3840
3492AGR-CT	-	Y	90-450	70-350	5.0	5.0	850	72.5	53.5	3840

## P-SERIES TORQUE WRENCHES

3/4" DRIVE

- Click type mechanism to signal when the required torque is reached
- Simple to adjust and easy to read Nm scale
- Locking button to ensure the set torque is securely maintained
- Compact head for easier use in confined spaces
- Quick release 72 teeth ratchet mechanism with twist reverse (DIN3 122)
- Designed to torque right hand (clockwise) fasteners
- Ergonomic bi-material grip for added comfort
- Marked to show the correct place where pressure should be applied
- Hanging facility which can be used together with a fall protection wire
- Accurate to +/- 4% and conforms to ISO6789 for assured accuracy
- Each torque wrench has it's own individual certification number
- Supplied in a handy storage case



ITEM ID:	Calibration Cert		Range		Scale		L mm	W mm	H mm	Weight g
	Factory	New	Nm	Nm	Nm	Nm				
3492P500	Y	-	100-500	2.5	790	68	62	3100		
3492P500-CT	-	Y	100-500	2.5	790	68	62	3100		





### TORQUE WRENCH SERVICE KITS

- Includes a set of replacement parts for the ratchet mechanism

ITEM ID:	Drive	Service Kit For:
1492AGERK	1/4"	1492AG-E
3892AG1RK	3/8"	3892AG-E1
3892AG3RK	3/8"	3892AG-E3
3892P060RK-1	3/8"	3892P060, 3892P100
DTQ100RK	3/8"	3892D100
1292AGERK	1/2"	1292AG-E, 1292AG-EP, & Pre Set Range
1292AGERRK	1/2"	1292AG-ER
1292AG4RK	1/2"	1292AG-E4
1292AG4RRK	1/2"	1292AG-E4R
1292P100RK-1	1/2"	1292P100
1292P200RK-1	1/2"	1292P200
DTQ200RK	1/2"	1292D200
3492AGERRK	3/4"	3492AG-ER
3492AGERK	3/4"	3492AG-E, 3492AG-E1, 3492AG-E2
3492P500RK-1	3/4"	3492P500

## Accessories

**NEW**

### P-SERIES INSERT TORQUE WRENCHES



- Click type mechanism to signal when the required torque is reached
- Simple to adjust and easy to read Nm scale
- Locking button to ensure the set torque is securely maintained
- Compact head for easier use in confined spaces
- Quick release 72 teeth ratchet mechanism with twist reverse (DIN3122)
- Designed to torque right hand (clockwise) fasteners
- Ergonomic bi-material grip for added comfort
- For use with the relevant insert torque tools
- Marked to show the correct place where pressure should be applied
- Hanging facility which can be used together with a fall protection wire
- Accurate to +/- 4% and conforms to ISO6789 for assured accuracy
- Each torque wrench has it's own individual certification number
- Supplied in a handy storage case



ITEM ID:	Head Size	Range	Scale	L mm	W mm	H mm	g
		Nm	Nm				
1292P912	9x12	20-100	0.5	400	36	36	862
1292P418	14x18	40-200	1.0	560	42	44	1096

### INSERT RATCHET ADAPTORS



- 45 teeth ratchet
- Designed for use with the P-SERIES insert torque wrenches
- Use with 3/8" drive sockets & accessories
- Satin finish

ITEM ID:	Fitting mm	W mm	H mm	L mm	L1 mm	g
3892CQ100R	9 x 12	35	36.5	36.3	20	150
1292CQ200R	14 x 18	42.5	46	70.5	24.4	288
3492CQ500R	14 x 18	68.8	69.8	98	36	988



### RING ENDED INSERT SPANNER

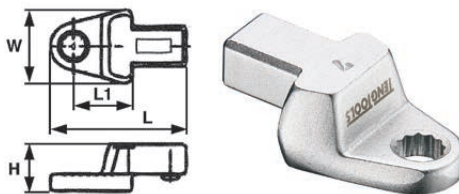

- 9 x 12mm rectangular fitting
- 12 point bi-hexagon ring end for easier alignment
- For use with quick change open end torque wrenches
- Ideal for use in confined spaces
- Easy to change
- Satin finish chrome vanadium steel

ITEM ID:	Size mm	Fitting mm	W mm	H mm	L mm	L1 mm	g
690710	10	9 x 12	26.5	16	45	18	52
690711	11	9 x 12	26.5	16	45	18	50
690712	12	9 x 12	26.7	16	46	18	48
690713	13	9 x 12	27.2	16	49	20	60
690714	14	9 x 12	27	18	50	20	64
690715	15	9 x 12	27	18	50	20	64
690716	16	9 x 12	27	18	50	20	62
690717	17	9 x 12	28.6	18	54	22	74
690718	18	9 x 12	28.6	18	54	22	74
690719	19	9 x 12	28.6	18	54	22	68



**OPEN ENDED INSERT SPANNER**

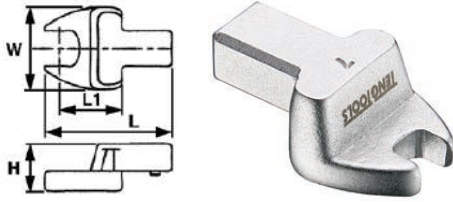

- 9 x 12mm rectangular fitting
- For use with quick change open end torque wrenches
- Ideal for use in confined spaces
- Easy to change
- Satin finish chrome vanadium steel

ITEM ID:	Size mm	Fitting mm	W mm	H mm	L mm	L1 mm	g
690510	10	9 x 12	30	15	39	18	42
690511	11	9 x 12	30	15	39	18	43
690512	12	9 x 12	30	16	40	18	48
690513	13	9 x 12	30	16	42	20	52
690514	14	9 x 12	35	17	42	20	59
690515	15	9 x 12	35	17	43	20	59
690516	16	9 x 12	38	18	43	20	67
690517	17	9 x 12	38	18	44	20	67
690518	18	9 x 12	42	18	46	22	75
690519	19	9 x 12	42	18	46	22	75

**RING ENDED INSERT SPANNER**

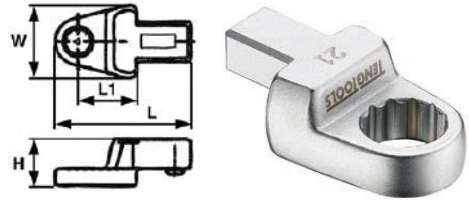

- 12 point bi-hexagon ring end for easier alignment to the fastening
- 14 x 18mm rectangular fitting
- For use with quick change open end torque wrenches
- Ideal for use in confined spaces
- Easy to change
- Satin finish chrome vanadium steel

ITEM ID:	Size mm	Fitting mm	W mm	H mm	L mm	L1 mm	g
690813	13	14 x 18	38	22	72	32	200
690814	14	14 x 18	38	22	72	32	200
690815	15	14 x 18	38	22	73	32	194
690816	16	14 x 18	38	24	73	32	204
690817	17	14 x 18	38	24	73	32	194
690818	18	14 x 18	44	24	75	32	234
690819	19	14 x 18	44	24	75	32	230
690821	21	14 x 18	41	26	76	32	236
690822	22	14 x 18	42	25	77	32	250
690824	24	14 x 18	42	26	78	32	254
690826	26	14 x 18	42	26	78	32	240
690827	27	14 x 18	43.4	27	82	34	280
690829	29	14 x 18	43.3	28	85	36	306
690830	30	14 x 18	47.3	28	87	36	328
690832	32	14 x 18	47.3	29	87	36	312
690834	34	14 x 18	50	29	90	38	324
690836	36	14 x 18	52	29	91	38	316
690838	38	14 x 18	54.6	31	94	40	342
690840	40	14 x 18	54.6	30	93	40	367
690841	41	14 x 18	60	32	99	42	376
690842	42	14 x 18	60	32	99	42	376
690844	44	14 x 18	60	31	99	44	386
690846	46	14 x 18	64.8	32	103	42	396



**OPEN ENDED INSERT SPANNER**

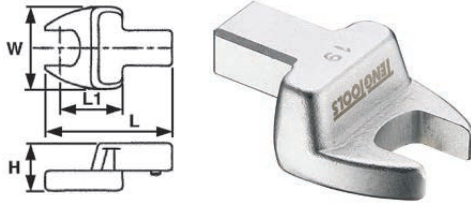

- 14 x 18mm rectangular fitting
- For use with quick change open end torque wrenches
- Ideal for use in confined spaces
- Easy to change
- Satin finish chrome vanadium steel

ITEM ID:	Size mm	Fitting mm	W mm	H mm	L mm	L1 mm	 g
690613	13	14 x 18	35	21	63	32	148
690614	14	14 x 18	35	22	63	32	154
690615	15	14 x 18	35	23	64	32	154
690616	16	14 x 18	38	23	64	32	173
690617	17	14 x 18	38	23	64	32	173
690618	18	14 x 18	42	24	65	32	192
690619	19	14 x 18	42	25	65	32	193
690621	21	14 x 18	50	25	66	32	217
690622	22	14 x 18	53	26	66	32	222
690624	24	14 x 18	53	26	67	32	225
690626	26	14 x 18	60	27	70	33	273
690627	27	14 x 18	60	27	70	34	281
690629	29	14 x 18	66	28	74	36	312
690630	30	14 x 18	66	28	74	36	312
690632	32	14 x 18	66	29	77	38	322
690634	34	14 x 18	73	29	82	43	345
690636	36	14 x 18	73	29	82	42	368
690638	38	14 x 18	73	29	82	41	366
690640	40	14 x 18	82	29	83	42	383
690641	41	14 x 18	82	29	84	42	400
690642	42	14 x 18	82	29	83	42	410
690644	44	14 x 18	91	29	86	41	423
690646	46	14 x 18	91	29	86	43	436



**ANGULAR GAUGE**

- For measuring the degree of turn
- For use when after tightening of stretch bolts with torque wrenches that do not have an in-built angular gauge
- A static read off point, fixing magnet and a pair of angle scales make it possible to take a reading in most situations

Item ID: TQAG

**TORQUE MULTIPLIERS**



- Ideal for tightening and loosening nuts and bolts where extra torque is required
- Supplied in a handy carrying case





**TORQUE MULTIPLIER SUPPORT LEGS**

- Support leg for the MP1400 torque multiplier
- Fits on to the torque multiplier head or can be used as a support for the handle
- Designed to create a steady position for safer operation

ITEM ID:	Support Leg for:
MPSL01	MP1400
MPSL02	MP2700

ITEM ID:	Max Torque		Ratio	Diameter mm	Input Drive	Output Drive	 g
	Nm	ft/lb					
MP1400	1500	1100	1:3	69	1/2"	3/4"	2280
MP2700	3000	2200	1:3	92	3/4"	1"	4780

**TORQUE MULTIPLIERS**



- Ideal for tightening and loosening nuts and bolts where extra torque is required
- Supplied in a handy carrying case

ITEM ID:	Max Torque		Ratio	Input Drive	Output Drive	 g
	Nm	ft/lb				
MP91500	1500	1100	1:10	1/2"	3/4"	3180



**TORQUE MULTIPLIER SERVICE KITS**

- Includes a set of replacement parts for the ratchet mechanism

ITEM ID:	Service Kit For:
MP1400RK-1	MP1400
MP2700RK-1	MP2700
MP91500RK	MP91500



Get organised!

Tray Size

TTX

**TORQUE MULTIPLIER SET**

1/2" DRIVE 3/4" DRIVE 2 Pieces

- Includes a 1/2" drive torque wrench giving a range of 40 to 210Nm
- The MP1400 torque multiplier can be used to multiply the torque at a ratio of 3:1 increasing the potential torque to 630Nm
- For use with 3/4" drive sockets

1/2" Drive Torque wrench (40-210Nm, 30-150 ft/lb)
1/2"F:3/4"M Torque multiplier (3 to 1 ratio) and maximum torque capacity 1,500Nm

Item ID: **TTXMP12**



Get organised!

Tray Size

TEX

**TORQUE MULTIPLIER SET**

1/2" DRIVE 3/4" DRIVE 2 Pieces EVA

- Includes a 1/2" drive torque wrench giving a range of 40 to 210Nm
- The MP1400 torque multiplier can then be used to multiply the torque at a ratio of 3:1 increasing the potential torque to 630Nm
- For use with 3/4" drive sockets
- Tools are held in place using three colour pre-cut EVA foam

1/2" Drive Torque wrench (40-210Nm, 30-150 ft/lb)
1/2"F:3/4"M Torque multiplier (3 to 1 ratio) and maximum torque capacity 1,500Nm

Item ID: **TEXMP12**

**TORQUE SPANNERS**

- Pre-set open jaw torque spanners
- Ideal for air conditioning engineers
- Accurate to +/-4% and conforms to ISO6789



ITEM ID	Spanner Size mm	Pre-Set Torque Nm	Weight g
TQS018	17	18	396
TQS042	22	42	428
TQS055	26	55	546
TQS065	29	65	576



4 Pieces EVA

**TORQUE SPANNER SET**

- Ideal for air conditioning engineers
- Set of 4 pre-set open jaw torque spanners
- Accurate to +/- 4% and conforms to ISO6789 for assured accuracy
- Individually tested and certified at the time of manufacturer
- Supplied in a handy carrying case

Spanner Size mm	Pre-Set Torque Nm
17	18
22	42
26	55
29	65

Item ID: **ACD01**

**DIGITAL TORQUE TESTERS**

- For checking the accuracy of torque wrenches
- Designed for checking clockwise torque readings
- Accurate to +/-1% of the measurement value
- Very easy to use with full instructions included
- Robust construction with fixing points for installation on a solid surface
- Supplied with a factory test certificate

ITEM ID	Plug Type	Range Nm	Depth mm	Width mm	Height mm	 g
TORQ02	Europe	1.5-30	205	155	76	2940
TORQ03	Europe	7.5-150	205	155	76	3940
TORQ04	Europe	25.500	205	155	76	4060
TORQ05	Europe	50-1000	205	155	76	4060
TORQ02U	UK	1.5-30	205	155	76	2940
TORQ03U	UK	7.5-150	205	155	76	3940
TORQ04U	UK	25.500	205	155	76	4060
TORQ05U	UK	50-1000	205	155	76	4060
TORQ02A	Aus / NZ	1.5-30	205	155	76	2940
TORQ03A	Aus / NZ	7.5-150	205	155	76	3940
TORQ04A	Aus / NZ	25.500	205	155	76	4060
TORQ05A	Aus / NZ	50-1000	205	155	76	4060

**DIGITAL TORQUE TESTER**

- For checking the accuracy of torque wrenches
- Designed for checking clockwise torque readings
- Accurate to +/-1% of the measurement value
- Very easy to use with full instructions included
- Robust construction with fixing points for installation on a solid surface
- Supplied with a factory test certificate

ITEM ID	Plug Type	Range Nm	Depth mm	Width mm	Height mm	 g
TORQ99E	Europe	10-400	200	160	85	2500
TORQ99U	UK	10-400	200	160	85	2500
TORQ99A	Aus / NZ	10-400	200	160	85	2500

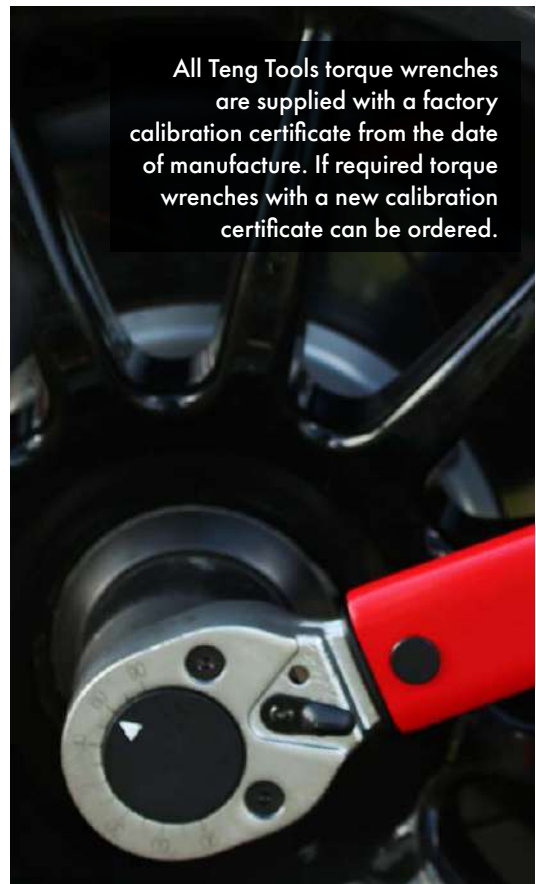

All Teng Tools torque wrenches are supplied with a factory calibration certificate from the date of manufacture. If required torque wrenches with a new calibration certificate can be ordered.





## TORQUE TESTER STAND

- Designed for mounting the TORQ99 torque tester and the TORP01 printer
- Creates a stand alone torque testing work station
- A robust construction creates a good, stable working position
- It features a storage shelf and adjustable feet to ensure steadiness on uneven surfaces



ITEM ID	Depth mm	Width mm	Height mm	Weight g
TORQS01	570	340	950	1640



## TORQUE TEST PRINTER



- For use together with the TengTools TORQ99 digital torque tester
- Enables a printed record of each reading
- Very easy to use with full instructions included

ITEM ID	Plug Type	Depth mm	Width mm	Height mm	Weight g
TORP01E	Europe	220	180	95	1840
TORP01U	UK	220	180	95	1840
TORP01A	Aus / NZ	220	180	95	1840

## TORQUE TESTER WITH STAND & PRINTER



\*Torque wrench & socket not included

- A complete torque test centre
- Creates a stand alone torque testing work station
- Designed for checking clockwise torque wrench readings
- Accurate to +/- 1% of the measurement value
- The printer enables a record to be kept of each reading
- Very easy to use with full instructions included
- The stand has a robust construction to create a stable working position
- It features a storage shelf and adjustable feet to ensure steadiness on uneven surfaces

ITEM ID	Plug Type	Range Nm	Depth mm	Width mm	Height mm	Weight g
TORQ	Europe	10-400	570	340	950	4350
TORQU	UK	10-400	570	340	950	4350
TORQA	Aus / NZ	10-400	570	340	950	4350



**PROFESSIONAL | RELIABLE | ACCURATE**

All things that make Teng Tools torque wrenches the right choice for you.

# SPANNERS

## QUALITY AS STANDARD

Our range has been developed over many years with DIN and ISO standards as the lowest benchmark when it comes to quality and size tolerances. This is a policy that has resulted in many top positions on best-buy lists in consumer and trade magazines. The range includes many different types of spanners for most application areas and personal taste.

### Combination Spanner Range

High mechanical performance and optimized for increased accessibility complying with DIN and ISO standards

Manufactured and designed in accordance with DIN3113A in high grade chrome vanadium steel

Size clearly marked on the side of the spanner for easy & quick visibility

The ring head is offset 15 degrees to facilitate use even on flat surfaces

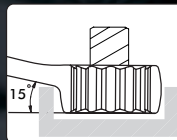

Teng Tools "Hip Grip" feature means the contact surface grips on the flat surfaces of the nut or bolt rather than on the corner







# GET A



# GRIP

## Anti-Slip Combination Spanners



Teng Tools "Hip Grip" feature means the contact surface grips on the flat surfaces of the nut or bolt rather than on the corner. This helps to prevent damage and makes it possible to grip nuts and bolts which already have damaged corners.

### HIP GRIP & ANTI SLIP

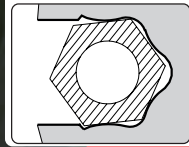

Features an anti-slip grip at the open end for a more secure grip on the fastening and avoids slipping

Hole in the handle for securing tool with fall protection equipment

Ergonomic design of the shaft ensures an improved grip to avoid slipping and cause injury

The ring head is offset 15 degrees and is also countersunk so you can gain access in confined areas

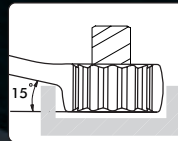

## Ratchet Spanner Range

15 degree offset head for easier use against flat surfaces

Lever for quick reversing between left and right-hand action

Straight ratchet ring to reach the nut flat

Flip over to reverse between left and right-hand action

Ring ratchet spanner with 180 degree flexible pivot to gain access to even the most hard to reach nuts and bolts.

12 TEETH - 5° INCREMENTS

12 TEETH - 5° INCREMENTS

12 TEETH - 5° INCREMENTS





### METRIC COMBINATION SPANNERS

- A ring and open ended spanner combined with the same size opening at each end
- Off set at 15° for easier use on flat surfaces
- TengTools hip grip design for contact with the flat side of the fastening
- Chrome vanadium satin finish
- Designed and manufactured to DIN3113A



mm

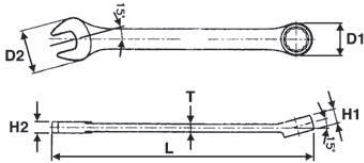

ITEM ID:	Size mm	L mm	H1 mm	H2 mm	D1 mm	D2 mm	T mm	g
600505	5.5	95	4.1	3.5	8.9	13.6	2.4	11
600506	6	100	4.7	4	10.1	15.5	2.7	17
600507	7	110	5	4	11.5	17	2.8	23
600508	8	120	5.5	4.5	12.8	19.2	3	25
600509	9	130	5.9	4.5	14.2	21.2	3.3	28
600510	10	140	6.5	5	15.6	23.2	3.5	38
600511	11	150	6.9	5.4	16.9	25.3	3.7	47
600512	12	160	7.3	5.5	18.3	27.2	3.9	60
600513	13	170	7.8	5.9	19.7	29.4	4.1	68
600514	14	180	8.3	6.2	21.2	31.5	4.4	84
600515	15	190	8.6	6.4	22.5	33.2	4.6	98
600516	16	200	8.9	6.7	24	34.7	4.8	104
600517	17	210	9.3	6.9	25.3	36.5	5	124
600518	18	220	9.9	7.2	26.8	38.7	5.2	141
600519	19	230	10.5	7.4	28.1	40.7	5.4	158
600520	20	240	10.9	7.7	29.7	43.1	5.6	184
600521	21	250	11.3	8	31.3	44.8	5.7	209
600522	22	260	11.5	8.2	32.6	46.9	5.8	216
600523	23	270	11.8	8.4	34.2	48.3	5.9	258
600524	24	280	12.1	8.7	35.5	50.4	6	265
600525	25	290	12.5	8.9	36.9	52	6.2	296
600526	26	300	12.8	9.2	38.2	53.6	6.4	342
600527	27	310	13.1	9.4	39.6	55.7	6.6	385
600528	28	320	13.3	9.7	40.9	57.6	6.8	397
600529	29	330	13.5	9.9	42.3	59.7	7	435
600530	30	340	13.7	10.1	43.7	61.8	7.1	459
600532	32	360	14.3	10.4	46.4	65.8	7.3	527

ITEM ID:	Size mm	L mm	H1 mm	H2 mm	D1 mm	D2 mm	T mm	g
600533	33	380	15	10.7	48.8	69.2	7.5	654
600534	34	380	15	10.7	48.8	69.2	7.5	674
600536	36	410	19.2	13.5	53.5	74	8	831
600538	38	430	20.4	15	56	77	9	967
600541	41	460	21.6	16	61	84	10	1257
600546	46	500	23	17	66	92	11	1693
600550	50	540	24.6	18	73	102	12	2048
600555	55	560	21.5	28	86	118	14.5	2800
600558	58	600	23.5	30	94	126	16	3900
600560	60	600	23.5	30	94	126	16	3900
600565	65	680	25	32	108	148	18	5800
600570	70	680	25	32	108	148	18	5800

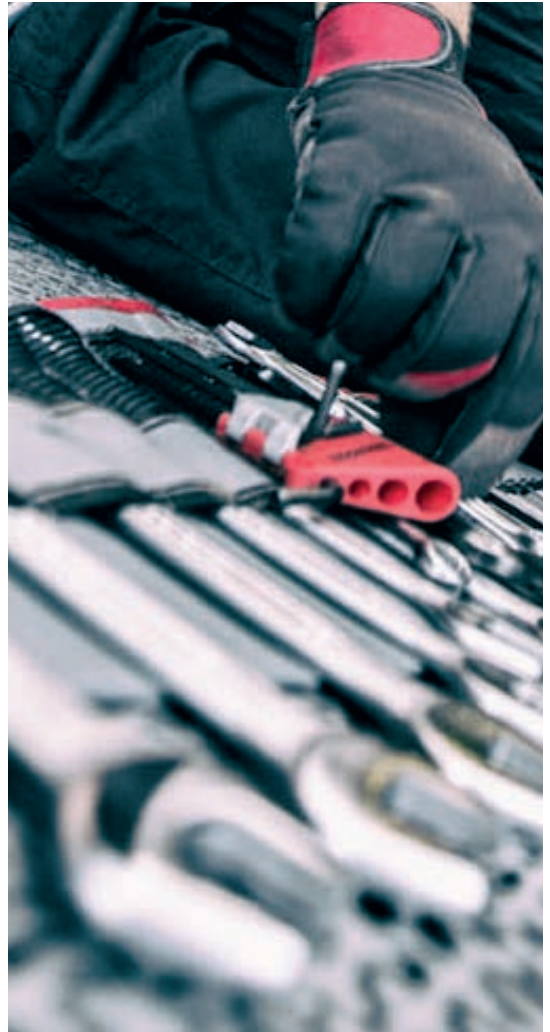

Continued ↑



**AF COMBINATION SPANNERS**

- A ring and open ended spanner combined with the same size opening at each end
- Off set at 15° for easier use on flat surfaces
- TengTools hip grip design for contact with the flat side of the fastening
- Chrome vanadium satin finish
- Designed and manufactured to DIN3113A



**AF**

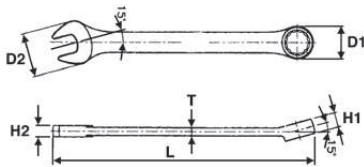

ITEM ID:	Size mm	L mm	H1 mm	H2 mm	D1 mm	D2 mm	T mm	g
600108	1/4"	100	4.7	4	10.1	15.5	2.7	16
600110	5/16"	120	5.5	4.5	12.8	19.2	3	25
600112	3/8"	140	6.5	5	15.6	23.2	3.5	37
600114	7/16"	150	6.9	5.4	16.9	25.3	3.7	50
600116	1/2"	170	7.8	5.9	19.7	29.4	4.1	69
600118	9/16"	180	8.3	6.2	21.2	31.5	4.4	80
600120	5/8"	200	8.9	6.7	24	34.7	4.8	107
600122	11/16"	210	9.3	6.9	25.3	36.5	5	127
600124	3/4"	230	10.5	7.4	28.1	40.7	5.4	157
600126	13/16"	250	11.3	8	31.3	44.8	5.7	212
600128	7/8"	260	11.5	8.2	32.6	46.9	5.8	204
600130	15/16"	280	12.1	8.7	35.5	50.4	6	264
600132	1"	290	12.5	8.9	36.9	52	6.2	310
600134	1-1/16"	310	13.1	9.4	39.6	55.7	6.6	400
600136	1-1/8"	330	13.3	9.7	40.9	57.6	6.8	415
600140	1-1/4"	360	14.3	10.4	46.4	65.8	7.3	540
600142	1-5/16"	380	15	10.7	48.8	69.2	7.5	649
600144	1-3/8"	410	19.2	13.5	53	74	8	858
600146	1-7/16"	410	19.2	13.5	53	74	8	838
600148	1-1/2"	430	20.4	15	56	77	9	1002
600152	1-5/8"	460	21.6	16	61	84	10	1309
600156	1-3/4"	500	23	17	66	92	11	1595
600160	1-7/8"	540	24.6	18	73	102	12	2097



**12** Pieces **mm**

**COMBINATION SPANNER SET**

- Off set at 15° for easier use on flat surfaces
- TengTools hip grip design for contact with the flat side of the fastening
- Chrome vanadium satin finish
- Designed and manufactured to DIN3113A

Combination Spanners:  
8, 9, 10, 11, 12, 13, 14, 15, 16, 17, 18, 19 mm

Item ID: **TT1236**



**7** Pieces **mm**

**COMBINATION SPANNER SET**

- Chrome vanadium, satin finish
- Off set at 15° for easier use on flat surfaces
- TengTools hip grip design for contact with the flat side of the fastening
- Designed and manufactured to DIN3113A

Combination Spanners:  
20, 21, 22, 24, 27, 30, 32 mm

Item ID: **TTX2032**



**8** Pieces **AF**

**COMBINATION SPANNER SET**

- Off set at 15° for easier use on flat surfaces
- TengTools hip grip design for contact with the flat side of the fastening
- Chrome vanadium satin finish
- Designed and manufactured to DIN3113A

Combination Spanners:  
5/16", 3/8", 7/16", 1/2", 9/16", 5/8", 11/16", 3/4"

Item ID: **TT3592**



Get organised!
Tray Size
TTA

### COMBINATION SPANNER SET

7 Pieces **AF**

- Chrome vanadium, satin finish
- Off set at 15° for easier use on flat surfaces
- TengTools hip grip design for contact with the flat side of the fastening
- Designed and manufactured to DIN3113A

Combination Spanners:

13/16", 7/8", 15/16", 1", 1-1/16", 1-1/8", 1-1/4"

Item ID: **TTX2640**



### COMBINATION SPANNER SET

12 Pieces **mm**

- Off set at 15° for easier use on flat surfaces
- TengTools hip grip design for contact with the flat side of the fastening
- Chrome vanadium satin finish
- Supplied with a wall rack for fixing to the wall or a workbench
- Designed and manufactured to DIN3113A

Combination Spanners:

8, 9, 10, 11, 12, 13, 14, 15, 16, 17, 18, 19 mm

Item ID: **WRSP12**



Get organised!
Tray Size
TED

### COMBINATION SPANNER SET

15 Pieces **mm** **EVA**

- Off set at 15° for easier use on flat surfaces
- TengTools hip grip design for contact with the flat side of the fastening
- Tools are held in place using three colour pre-cut EVA foam
- Designed and manufactured to DIN3113A

Combination Spanners:

5,5, 6, 7, 8, 9, 10, 11, 12, 13, 14, 15, 16, 17, 18, 19 mm

Item ID: **TED6515**



### COMBINATION SPANNER SET

12 Pieces **mm**

- Off set at 15° for easier use on flat surfaces
- TengTools hip grip design for contact with the flat side of the fastening
- Chrome vanadium satin finish
- Designed and manufactured to DIN3113A

Combination Spanners:

8, 9, 10, 11, 12, 13, 14, 15, 16, 17, 18, 19 mm

Item ID: **6512N**



Get organised!
Tray Size
TEX

### COMBINATION SPANNER SET

7 Pieces **mm** **EVA**

- Chrome vanadium, satin finish
- Off set at 15° for easier use on flat surfaces
- TengTools hip grip design for contact with the flat side of the fastening
- Tools are held in place using three colour pre-cut EVA foam
- Designed and manufactured to DIN3113A

Combination Spanners:

20, 21, 22, 24, 27, 30, 32 mm

Item ID: **TEX2032**



12 Pieces **mm**

**COMBINATION SPANNER SET**

- Off set at 15° for easier use on flat surfaces
- TengTools hip grip design for contact with the flat side of the fastening
- Chrome vanadium satin finish
- Designed and manufactured to DIN3113A

Combination Spanners:
8, 9, 10, 11, 12, 13, 14, 15, 16, 17, 19, 22 mm

Item ID: **6512**



21 Pieces **mm**

**COMBINATION SPANNER SET**

- Off set at 15° for easier use on flat surfaces
- TengTools hip grip design for contact with the flat side of the fastening
- Chrome vanadium satin finish
- Designed and manufactured to DIN3113A

Combination Spanners:
6, 7, 8, 9, 10, 11, 12, 13, 14, 15, 16, 17, 18, 19, 20, 21, 22, 24, 27, 30, 32 mm

Item ID: **6521**



17 Pieces **mm**

**COMBINATION SPANNER SET**

- Off set at 15° for easier use on flat surfaces
- TengTools hip grip design for contact with the flat side of the fastening
- Chrome vanadium satin finish
- Designed and manufactured to DIN3113A

Combination Spanners:
6, 7, 8, 9, 10, 11, 12, 13, 14, 15, 16, 17, 18, 19, 20, 21, 22 mm

Item ID: **6517**



10 Pieces **mm**

**COMBINATION SPANNER SET**

- Off set at 15° for easier use on flat surfaces
- TengTools hip grip design for contact with the flat side of the fastening
- Chrome vanadium satin finish
- Supplied in a handy tool roll style wallet
- Designed and manufactured to DIN3113A

Combination Spanners:
8, 9, 10, 11, 12, 13, 14, 15, 17, 19 mm

Item ID: **6510MM**





### COMBINATION SPANNER SET

12 Pieces mm

- Off set at 15° for easier use on flat surfaces
- TengTools hip grip design for contact with the flat side of the fastening
- Chrome vanadium satin finish
- Supplied in a handy tool roll style wallet
- Designed and manufactured to DIN3113A

Combination Spanners:

8, 9, 10, 11, 12, 13, 14, 15, 16, 17, 18, 19 mm

Item ID: 6512MM1



### COMBINATION SPANNER SET

17 Pieces mm

- Off set at 15° for easier use on flat surfaces
- TengTools hip grip design for contact with the flat side of the fastening
- Chrome vanadium satin finish
- Supplied in a handy tool roll style wallet
- Designed and manufactured to DIN3113A

Combination Spanners:

6, 7, 8, 9, 10, 11, 12, 13, 14, 15, 16, 17, 18, 19, 20, 21, 22 mm

Item ID: 6517MM



### COMBINATION SPANNER SET

15 Pieces mm

- Off set at 15° for easier use on flat surfaces
- TengTools hip grip design for contact with the flat side of the fastening
- Chrome vanadium satin finish
- Supplied in a handy tool roll style wallet
- Designed and manufactured to DIN3113A

Combination Spanners:

5.5, 6, 7, 8, 9, 10, 11, 12, 13, 14, 15, 16, 17, 18, 19 mm

Item ID: 6515MM



### COMBINATION SPANNER SET

12 Pieces mm

- Off set at 15° for easier use on flat surfaces
- TengTools hip grip design for contact with the flat side of the fastening
- Chrome vanadium satin finish
- Supplied in a handy tool roll style wallet
- Designed and manufactured to DIN3113A

Combination Spanners:

20, 21, 22, 23, 24, 25, 26, 27, 28, 29, 30, 32 mm

Item ID: 6512MM

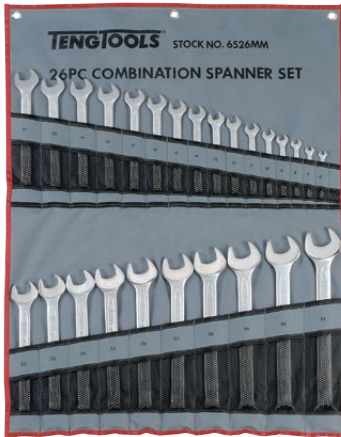

**COMBINATION SPANNER SET**

26 Pieces **mm**

- Off set at 15° for easier use on flat surfaces
- TengTools hip grip design for contact with the flat side of the fastening
- Chrome vanadium satin finish
- Supplied in a handy tool roll style wallet
- Designed and manufactured to DIN3113A

Combination Spanners:
6, 7, 8, 9, 10, 11, 12, 13, 14, 15, 16, 17, 18, 19, 20, 21, 22, 23, 24, 25, 26, 27, 28, 29, 30, 32 mm

Item ID: **6526MM**



**COMBINATION SPANNER SET**

7 Pieces **mm**

- Off set at 15° for easier use on flat surfaces
- TengTools hip grip design for contact with the flat side of the fastening
- Chrome vanadium satin finish
- Supplied in a handy tool roll style wallet
- Designed and manufactured to DIN3113A

Combination Spanners:
33, 34, 36, 38, 41, 46, 50 mm

Item ID: **6507JMM**



**COMBINATION SPANNER SET**

9 Pieces **AF**

- Off set at 15° for easier use on flat surfaces
- TengTools hip grip design for contact with the flat side of the fastening
- Chrome vanadium satin finish
- Supplied in a handy tool roll style wallet
- Designed and manufactured to DIN3113A

Combination Spanners:
1/4", 5/16", 3/8", 7/16", 1/2", 9/16", 5/8", 11/16", 3/4"

Item ID: **6509AF**



**COMBINATION SPANNER SET**

7 Pieces **AF**

- Off set at 15° for easier use on flat surfaces
- TengTools hip grip design for contact with the flat side of the fastening
- Chrome vanadium satin finish
- Supplied in a handy tool roll style wallet
- Designed and manufactured to DIN3113A

Combination Spanners:
13/16", 7/8", 15/16", 1", 1-1/16", 1-1/8", 1-1/4"

Item ID: **6507AF**





### COMBINATION SPANNER SET

7 Pieces **AF**

- Off set at 15° for easier use on flat surfaces
- TengTools hip grip design for contact with the flat side of the fastening
- Chrome vanadium satin finish
- Supplied in a handy tool roll style wallet
- Designed and manufactured to DIN3113A

#### Combination Spanners:

1-5/16", 1-3/8", 1-7/16", 1-1/2", 1-5/8", 1-3/4", 1-7/8"

Item ID: **6507JAF**



### COMBINATION SPANNER SET

10 Pieces **mm**

- Off set at 15° for easier use on flat surfaces
- TengTools hip grip design for contact with the flat side of the fastening
- Chrome vanadium satin finish
- Supplied in a holder that can be used for storage or for mounting on a wall
- Designed and manufactured to DIN3113A

#### Combination Spanners:

8, 10, 11, 12, 13, 14, 15, 16, 17, 19 mm

Item ID: **6510A**

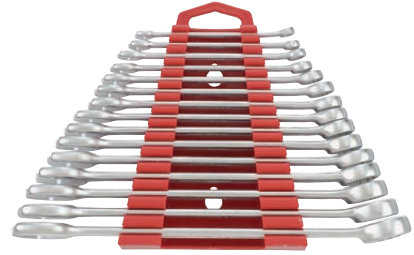

### COMBINATION SPANNER SET

15 Pieces **mm**

- Off set at 15° for easier use on flat surfaces
- TengTools hip grip design for contact with the flat side of the fastening
- Chrome vanadium satin finish
- Spanner holder can be used on it's own or it can be connected to set: 6512MMA
- Designed and manufactured to DIN3113A

#### Combination Spanners:

5.5, 6, 7, 8, 9, 10, 11, 12, 13, 14, 15, 16, 17, 18, 19 mm

Item ID: **6515MMA**

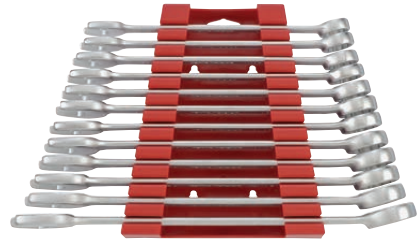

### COMBINATION SPANNER SET

12 Pieces **mm**

- Off set at 15° for easier use on flat surfaces
- TengTools hip grip design for contact with the flat side of the fastening
- Chrome vanadium satin finish
- Spanner holder can be used on it's own or it can be connected to sets: 6512MMA and/or 6507JMMA
- Designed and manufactured to DIN3113A

#### Combination Spanners:

20, 21, 22, 23, 24, 25, 26, 27, 28, 29, 30, 32 mm

Item ID: **6512MMA**

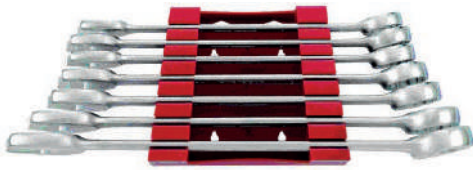

7 Pieces **mm**

**COMBINATION SPANNER SET**

- Off set at 15° for easier use on flat surfaces
- TengTools hip grip design for contact with the flat side of the fastening
- Chrome vanadium satin finish
- Spanner holder can be used on it's own or it can be connected to set: 6512MMA
- Designed and manufactured to DIN3113A

Combination Spanners:
33, 34, 36, 38, 41, 46, 50 mm

Item ID: **6507JMMA**

**ANTI SLIP COMBINATION SPANNERS**

- Anti slip metric combination spanner
- Off set at 15° for easier use on flat surfaces
- TengTools hip grip design on the ring and open end for contact with the flat side of the fastening
- TengTools anti slip design on the open end to give a much better grip with less risk of damaging the fastening

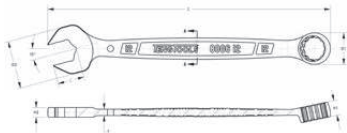

ITEM ID:	Size mm	L mm	H1 mm	H2 mm	D1 mm	D2 mm	T mm	g
800608	8	120	6.6	4.5	12.8	18.9	3.2	24
800609	9	130	7	4.5	14.2	20.8	3.2	28
800610	10	140	7.7	5	15.6	22.5	3.6	36
800611	11	150	8.4	5.4	16.9	24.5	3.6	46
800612	12	160	8.5	5.5	18	27.2	3.6	58
800613	13	170	8.8	5.9	19.5	29.6	3.9	71
800614	14	180	9.6	6.2	21.5	31.1	4	81
800615	15	185	10.1	6.4	22.8	32.5	4.2	93
800616	16	195	10.5	6.5	24.2	35	4.5	110
800617	17	202	11	6.9	25.2	37	4.5	123
800618	18	208	11.5	7.1	26.8	39	4.8	135
800619	19	218	12.2	7.5	28.4	41.1	5	156



Get organised!  
Tray Size  
TT

12 Pieces **mm**

**ANTI SLIP COMBINATION SPANNER SET**

- Off set at 15° for easier use on flat surfaces
- TengTools hip grip design for contact with the flat side of the fastening
- TengTools anti slip design on the open end to give a much better grip

Anti Slip Combination Spanners:
8, 9, 10, 11, 12, 13, 14, 15, 16, 17, 18, 19 mm



Item ID: **TT8012**



Get organised!  
Tray Size  
TED

12 Pieces **mm** **EVA**

**ANTI SLIP COMBINATION SPANNER SET**

- Off set at 15° for easier use on flat surfaces
- TengTools hip grip design on the ring and open end for contact with the flat side of the fastening
- TengTools anti slip design on the open end to give a much better grip
- Tools are held in place using three colour pre-cut EVA foam

Anti Slip Combination Spanners:
8, 9, 10, 11, 12, 13, 14, 15, 16, 17, 18, 19 mm



Item ID: **TED8012**



### ANTI SLIP COMBINATION SPANNER SET

12 Pieces mm

- Off set at 15° for easier use on flat surfaces
- TengTools hip grip design on the ring and open end for contact with the flat side of the fastening
- TengTools anti slip design on the open end to give a much better grip
- Supplied with a wall rack for fixing to the wall or a workbench

Anti Slip Combination Spanners:

8, 9, 10, 11, 12, 13, 14, 15, 16, 17, 18, 19 mm



Item ID: **WR8012**



### ANTI SLIP COMBINATION SPANNER SET

12 Pieces mm

- Off set at 15° for easier use on flat surfaces
- TengTools hip grip design on the ring and open end for contact with the flat side of the fastening
- TengTools anti slip design on the open end to give a much better grip with less risk of damaging the fastening
- Supplied in a holder that can be used for storage or for mounting on a wall

Anti Slip Combination Spanners:

8, 9, 10, 11, 12, 13, 14, 15, 16, 17, 18, 19 mm



Item ID: **8512A**



### ANTI SLIP COMBINATION SPANNER SET

12 Pieces mm

- Off set at 15° for easier use on flat surfaces
- TengTools hip grip design on the ring and open end for contact with the flat side of the fastening
- TengTools anti slip design on the open end to give a much better grip with less risk of damaging the fastening
- Supplied in a handy tool roll style wallet

Anti Slip Combination Spanners:

8, 9, 10, 11, 12, 13, 14, 15, 16, 17, 18, 19 mm



Item ID: **8512MM**

### STUBBY COMBINATION SPANNERS

- Ideal for use in confined spaces
- Off set at 15° for easier use on flat surfaces
- TengTools hip grip design for contact with the flat side of the fastening
- Chrome vanadium satin finish
- Designed and manufactured to DIN3113A

mm

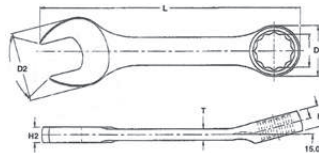

ITEM ID:	Size mm	L mm	H1 mm	H2 mm	D1 mm	D2 mm	T mm	g
6005M10	10	95	7	5.1	16.2	21.9	3.4	30
6005M11	11	100	7.8	5.9	17.9	23.8	4	42
6005M12	12	105	8.2	6.6	19.1	24.7	4.2	48
6005M13	13	110	8.8	6.7	19.3	27.1	5	55
6005M14	14	115	9.1	7.4	21.8	28.9	5.1	66
6005M15	15	120	9.2	7.5	22.6	31.1	5.1	71
6005M16	16	125	9.8	8.1	23.6	33	5.6	87
6005M17	17	130	10.3	8.3	25.9	36	5.6	105
6005M18	18	135	11	8.7	27.2	36.8	5.8	118
6005M19	19	140	11.2	9.4	28.7	38.1	6	130

"Hip Grip"

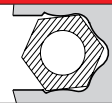

Teng Tools "Hip Grip" feature means the contact surface grips on the flat surfaces of the nut or bolt rather than on the corner.

This helps to prevent damage and makes it possible to grip nuts and bolts which already have damaged corners.

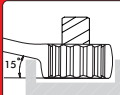



10 Pieces **mm**

**MIDGET COMBINATION SPANNER SET**

- Short stubby spanners for use in confined spaces
- Off set at 15° for easier use on flat surfaces
- TengTools hip grip design for contact with the flat side of the fastening
- Chrome vanadium satin finish
- Designed and manufactured to DIN3113A

Midget Combination Spanners:

10, 11, 12, 13, 14, 15, 16, 17, 18, 19 mm

Item ID: **TT6010M**

**EXTRA LONG COMBINATION SPANNERS**

- A ring and open ended spanner with the same size at each end
- Off set at 15° for easier use on flat surfaces
- TengTools hip grip design on the ring end for contact with the flat side of the fastening
- Chrome vanadium satin finish
- Designed and manufactured to DIN3113A



**mm**

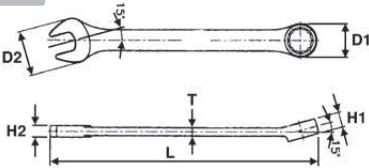

ITEM ID:	Size mm	L mm	H1 mm	H2 mm	D1 mm	D2 mm	T mm	 g
605908	8	148	5.3	4.9	12.6	17.2	3.6	33
605909	9	158	6.2	5	13.7	19.4	3.8	40
605910	10	168	6.4	5.6	15.2	21.7	3.9	50
605911	11	188	7.3	5.6	16.7	23.1	4.2	62
605912	12	198	7.9	6.3	17.7	25.3	4.2	77
605913	13	208	8.6	6.7	19.8	26.6	4.5	87
605914	14	228	9	7.4	21.4	29.8	5	117
605915	15	238	9.9	7.6	22.5	32.4	5	142
605916	16	246	10.4	8.2	23.5	32.4	5.2	153
605917	17	266	10.5	8.2	25.4	36	5.8	174
605918	18	276	12.4	9	26.6	37.4	5.8	215
605919	19	285	12.6	9.1	28.3	39.8	6.1	220



12 Pieces **mm**

**LONG REACH COMBINATION SPANNER SET**

- Extra long for increased torque
- Off set at 15° for easier use on flat surfaces
- TengTools hip grip design for contact with the flat side of the fastening
- Designed and manufactured to DIN3113A

Combination Spanners:

8, 9, 10, 11, 12, 13, 14, 15, 16, 17, 18, 19 mm

Item ID: **TTXLM12**



12 Pieces **mm**

**LONG REACH COMBINATION SPANNER SET**

- Extra long for increased torque
- Off set at 15° for easier use on flat surfaces
- TengTools hip grip design for contact with the flat side of the fastening
- Supplied with a wall rack for fixing to the wall or a workbench
- Designed and manufactured to DIN3113A

Extra Long Combination Spanners:

8, 9, 10, 11, 12, 13, 14, 15, 16, 17, 18, 19 mm

Item ID: **WRSP12LMP**



9 Pieces

mm

### EXTRA LONG COMBINATION SPANNER SET

- Extra long for increased torque
- Off set at 15° for easier use on flat surfaces
- TengTools hip grip design for contact with the flat side of the fastening
- Supplied in a handy tool roll style wallet
- Designed and manufactured to DIN3113A

Extra Long Combination Spanners:

8, 10, 11, 12, 13, 14, 15, 17, 19 mm

Item ID: 6059LMP



### RATCHETING COMBINATION SPANNER

- A ratcheting ring and open ended spanner combined with the same size at each end
- Off set at 13° for easier use on flat surfaces
- TengTools hip grip design on the ring end for contact with the flat side of the fastening
- 72 teeth ratchet spanners giving a 5° increment between clicks
- Reversible ratchet mechanism with a flip reverse lever
- Ideal for rapid tightening and loosening of fastenings
- Chrome vanadium satin finish
- Designed and manufactured to DIN ISO 1711-1 and DIN 3113A

mm

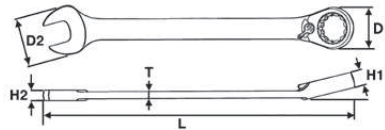

ITEM ID:	Size mm	L mm	H1 mm	H2 mm	D1 mm	D2 mm	T mm	g
600508R	8	140	6.5	4	17	17	2.8	30
600509R	9	150	6.9	4.4	18.5	19	2.7	30
600510R	10	159	7.3	4.8	20	21	3.3	50
600511R	11	165	7.7	5.2	22	23	3.6	70
600512R	12	172	8.2	5.5	23	25	3.9	80
600513R	13	178	8.5	5.8	25	27	4	100
600514R	14	191	9	6.2	27	29	4.3	120
600515R	15	200	9.4	6.5	28	31	4.5	140
600516R	16	208	9.9	6.8	30	33	4.7	170
600517R	17	226	10.3	7.2	32	36	5	200
600518R	18	237	10.7	7.7	33	38	5.2	210
600519R	19	248	11.2	8.2	34	40	5.5	220
600522R	22	290	13	9	38.4	45	6	360
600524R	24	323	14.5	9.8	43.6	52	6.5	510
600527R	27	359	15.5	10.5	52.5	56	7.7	640
600530R	30	403	17	11.4	58.5	59	8.2	880
600532R	32	425	17.5	12.5	62.5	63	8.7	1080



**AF RATCHETING COMBINATION SPANNERS**

- A ratcheting ring and open ended spanner combined with the same size at each end
- Off set at 13° for easier use on flat surfaces
- TengTools hip grip design on the ring end for contact with the flat side of the fastening
- 72 teeth ratchet spanners giving a 5° increment between clicks
- Reversible ratchet mechanism with a flip reverse lever
- Ideal for rapid tightening and loosening of fastenings
- Chrome vanadium satin finish
- Designed and manufactured to DIN ISO 1711-1 and DIN 3113A



**AF**

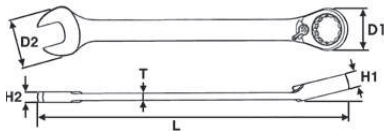

ITEM ID:	Size mm	L mm	H1 mm	H2 mm	D1 mm	D2 mm	T mm	g
600110R	5/16"	140	6.5	4.6	16.6	16.7	3	30
600112R	3/8"	159	7.3	5.3	20	20.8	3.4	50
600114R	7/16"	165	7.7	5.6	21.8	23	3.7	70
600116R	1/2"	178	8.6	6.4	24.7	27.1	4.1	100
600118R	9/16"	191	9	6.8	27	29.2	4.4	120
600120R	5/8"	208	9.9	7.2	30	33.4	4.7	170
600122R	11/16"	226	10.3	7.7	31.8	35.5	5.1	200
600124R	3/4"	248	11.2	8.8	33.8	39.7	5.6	320
600126R	13/16"	290	13	9	40	46	6	360
600128R	7/8"	290	13	9	40	46	6	510



Get organised  
Tray Size  
TT

11 Pieces **mm**

**RATCHET SPANNER SET**

- 72 teeth ratchet spanners giving a 5° increment between clicks
- Reversible ratchet mechanism with hip grip & flip reverse lever
- Chrome vanadium satin finish
- Designed and manufactured to DIN ISO 1711-1 and DIN 3113A

Ratchet Spanners with flip reverse:  
8, 10, 11, 12, 13, 14, 15, 16, 17, 18, 19 mm

Item ID: **TT6511R**



Get organised  
Tray Size  
TT

8 Pieces **AF**

**RATCHET SPANNER SET**

- 72 teeth ratchet spanners giving a 5° increment between clicks
- Reversible ratchet mechanism with a flip reverse lever
- Chrome vanadium satin finish
- Designed and manufactured to DIN ISO 1711-1 and DIN 3113A

Ratchet Spanners with flip reverse:  
5/16", 3/8", 7/16", 1/2", 9/16", 5/8", 11/16", 3/4"

Item ID: **TT6508RAF**



Get organised  
Tray Size  
TT

8 Pieces **mm**

**RATCHET SPANNER SET**

- 72 teeth ratchet spanners giving a 5° increment between clicks
- Reversible ratchet mechanism with a flip reverse lever
- TengTools hip grip design on the ring end
- Chrome vanadium satin finish
- Designed and manufactured to DIN ISO 1711-1 and DIN 3113A

Ratchet Spanners with flip reverse:  
8, 10, 11, 12, 13, 14, 17, 19 mm

Item ID: **TT6508R**



Get organised  
Tray Size  
TED

12 Pieces **mm** **EVA**

**RATCHET SPANNER SET**

- 72 teeth ratchet spanners giving a 5° increment between clicks
- Reversible ratchet mechanism with hip grip & flip reverse lever
- Tools are held in place using three colour pre-cut EVA foam
- Designed and manufactured to DIN ISO 1711-1 and DIN 3113A

Ratchet Spanners with flip reverse:  
8, 9, 10, 11, 12, 13, 14, 15, 16, 17, 18, 19 mm

Item ID: **TED6512R**



### RATCHET SPANNER SET

8 Pieces mm

- 72 teeth ratchet spanners giving a 5° increment between clicks
- Reversible ratchet mechanism with hip grip & flip reverse lever
- Chrome vanadium satin finish
- Supplied in a handy tool roll style wallet
- Designed and manufactured to DIN3113A

Ratchet Spanners with flip reverse:

8, 10, 11, 12, 13, 14, 17, 19 mm

Item ID: **6508RMM**



### RATCHET SPANNER SET

10 Pieces mm

- 72 teeth ratchet spanners giving a 5° increment between clicks
- Reversible ratchet mechanism with hip grip & flip reverse lever
- Chrome vanadium satin finish
- Supplied in a handy tool roll style wallet
- Designed and manufactured to DIN ISO 1711-1 and DIN 3113A

Ratchet Spanners with flip reverse:

10, 11, 12, 13, 14, 15, 16, 17, 18, 19 mm

Item ID: **6510RMM**

### RATCHETING COMBINATION SPANNERS

- A ratcheting ring and open ended spanner combined with the same size at each end
- Simply turn over to reverse the direction of use when ratcheting
- TengTools hip grip design on the ring end for contact with the flat side of the fastening
- 72 teeth ratchet spanners giving a 5° increment between clicks
- Ideal for rapid tightening and loosening of fastenings
- Chrome vanadium satin finish
- Designed and manufactured to DIN ISO 1711-1 and DIN 3113A

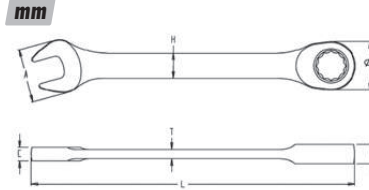

ITEM ID:	Size mm	L mm	A mm	B mm	C mm	D mm	H mm	T mm	g
600508RS	8	111	19.6	17	4	6.8	8	2.8	30
600509RS	9	123	20.8	19	4.4	7.2	9	2.9	41
600510RS	10	131	22	20	4.8	7.6	9.5	3.3	48
600511RS	11	147	24.2	21	5.2	8	10	3.6	62
600512RS	12	155	25.7	23	5.5	8.5	11	3.9	78
600513RS	13	164	27.2	25	5.8	8.9	12	4	88
600514RS	14	182	30.8	27	6.2	9.3	13	4.3	112
600515RS	15	192	32.4	28	6.5	9.7	13.6	4.5	123
600516RS	16	202	34	30	6.8	10.2	14.4	4.7	144
600517RS	17	223	37.7	32	7.2	10.6	15.3	5	192
600518RS	18	234	39.3	33	7.7	11	16.2	5.2	207
600519RS	19	246	40.8	34	8.2	11.5	17	5.5	233
600520RS	20	285	46	42	10	13	18.8	6.4	385
600521RS	21	285	46	42	10	13	18.8	6.4	385
600522RS	22	285	46	42	10	13	18.8	6.4	387
600524RS	24	325	51.5	47.5	11	14.5	20.6	7	511



8 Pieces **mm**

**RATCHET SPANNER SET**

- 72 teeth ratchet spanners giving a 5° increment between clicks
- Simply turn over to reverse the direction of use when ratcheting
- Chrome vanadium satin finish
- Designed and manufactured to DIN ISO 1711-1 & DIN 3113A

Ratchet Spanners:
8, 10, 11, 12, 13, 14, 17, 19 mm

Item ID: **TT6508RS**



11 Pieces **mm**

**RATCHET SPANNER SET**

- 72 teeth ratchet spanners giving a 5° increment between clicks
- Hip grip on the ring end, turn spanner over to change direction
- Chrome vanadium satin finish
- Designed and manufactured to DIN ISO 1711-1 and DIN 3113A

Ratchet Spanners:
8, 10, 11, 12, 13, 14, 15, 16, 17, 18, 19 mm

Item ID: **TT6511RS**



12 Pieces **mm** **EVA**

**RATCHET SPANNER SET**

- 72 teeth ratchet spanners giving a 5° increment between clicks
- Hip grip on the ring end, turn spanner over to change direction
- Tools are held in place using three colour pre-cut EVA foam
- Designed and manufactured to DIN ISO 1711-1 and DIN 3113A

Ratchet Spanners:
8, 9, 10, 11, 12, 13, 14, 15, 16, 17, 18, 19 mm

Item ID: **TED6512RS**



12 Pieces **mm**

**RATCHET SPANNER SET**

- 72 teeth ratchet spanners giving a 5° increment between clicks
- Simply turn over to reverse the direction of use when ratcheting
- Chrome vanadium satin finish
- Supplied with a wall rack for fixing to the wall or a workbench
- Designed and manufactured to DIN ISO 1711-1 and DIN 3113A

Ratchet Spanners:
8, 9, 10, 11, 12, 13, 14, 15, 16, 17, 18, 19 mm

Item ID: **WRSP12RS**



8 Pieces **mm**

**RATCHET SPANNER SET**

- 72 teeth ratchet spanners giving a 5° increment between clicks
- Hip grip on the ring end, turn spanner over to change direction
- Chrome vanadium satin finish
- Supplied in a handy tool roll style wallet
- Designed and manufactured to DIN ISO 1711-1 and DIN 3113A

Ratchet Spanners:
8, 10, 11, 12, 13, 14, 17, 19 mm

Item ID: **6508RSMM**



### RATCHET SPANNER SET

12 Pieces mm

- 72 teeth ratchet spanners giving a 5° increment between clicks
- Hip grip on the ring end, turn spanner over to change direction
- Chrome vanadium satin finish
- Supplied in a handy tool roll style wallet
- Designed and manufactured to DIN ISO 1711-1 and DIN 3113A

Ratchet Spanners:

8, 9, 10, 11, 12, 13, 14, 15, 16, 17, 18, 19 mm

Item ID: **6512RSMM**



### RATCHET SPANNER SET

12 Pieces mm

- 72 teeth ratchet spanners giving a 5° increment between clicks
- Hip grip on the ring end, turn spanner over to change direction
- Chrome vanadium satin finish
- Designed and manufactured to DIN ISO 1711-1 and DIN 3113A

Ratchet Spanners:

8, 9, 10, 11, 12, 13, 14, 15, 16, 17, 18, 19 mm

Item ID: **65RS12**

### FLEXIBLE HEAD RATCHET SPANNERS

- A ratcheting ring and open ended spanner with the same size at each end
- TengTools hip grip design on the ring end for contact with the flat side of the fastening
- 72 teeth ratchet spanners giving a 5° increment between clicks
- Reversible ratchet mechanism
- Ideal for rapid tightening and loosening of fastenings
- Chrome vanadium satin finish
- Designed and manufactured to DIN ISO 1711-1 and DIN 3113A



mm

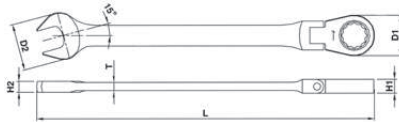

ITEM ID:	Size mm	L mm	H1 mm	H2 mm	D1 mm	D2 mm	T mm	g
600507RF	7	127	6.8	4	17	17.6	2.8	50
600508RF	8	127	6.8	4	17	17.6	2.8	50
600509RF	9	131	7.2	4.4	19	19.8	2.9	50
600510RF	10	136	7.6	4.8	20	22	3.3	60
600511RF	11	141	8	5.2	21	24.1	3.6	60
600512RF	12	147	8.5	5.5	23	25.9	3.9	80
600513RF	13	154	9	5.8	25	27.3	4	100
600514RF	14	160	9.3	6.2	27	30.6	4.3	120
600515RF	15	169	9.7	6.5	28	32.2	4.3	120
600516RF	16	179	10.2	6.8	30	33.7	4.7	160
600517RF	17	190	10.6	7.2	32	36.6	5	190
600518RF	18	203	11	7.7	33	38.4	5.2	190
600519RF	19	215	11.5	8.2	34	40.2	5.5	200



8 Pieces mm

### FLEXIBLE HEAD RATCHET SPANNER SET

- 72 teeth ratchet spanners giving a 5° increment between clicks
- Flexible head for use at an angle or for reversing the direction of use when ratcheting
- Chrome vanadium satin finish
- Removable lid and dove tail joints

Flexible head Ratchet Spanners:

8, 10, 11, 12, 13, 14, 17, 19 mm

Item ID: **TT6508RF**

**DOUBLE RING SPANNERS**

- Different size at each end to give 2 sizes with one wrench
- Double curved heads offset at 75° for easier use on flat surfaces
- Chrome vanadium satin finish
- TengTools hip grip design for contact with the flat side of the fastening
- Designed and manufactured to DIN 838

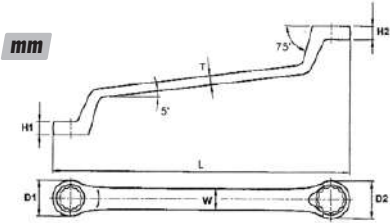

ITEM ID:	Size mm	L mm	H1 mm	H2 mm	D1 mm	D2 mm	T mm	 g
630607	6x7	168	5.6	6.3	10.7	12.2	4.1	45
630809	8x9	183	6.6	7	13.6	15.1	4.5	60
631011	10x11	198	7.4	7.7	16.6	18	4.9	100
631213	12x13	217	8.1	8.4	19.5	20.9	5.4	105
631415	14x15	239	8.8	9.1	22.4	23.7	5.7	145
631617	16x17	260	9.5	9.8	25.3	26.7	6.2	195
631819	18x19	292	10.1	10.4	28.2	29.7	6.6	250
632022	20x22	318	10.9	11.4	31.1	34	7.1	320
632123	21x23	326.5	11.2	11.6	32.6	35.5	7.6	340
632427	24x27	329	12.4	13.4	36.9	41	8.1	475
633032	30x32	362	14.4	15.2	45.5	48.5	9	522

**NEW** DOUBLE RING SPANNERS

- Different size at each end to give 2 sizes with one wrench
- Double curved heads offset at 75° for easier use on flat surfaces
- Chrome vanadium satin finish
- TengTools hip grip design for contact with the flat side of the fastening
- Designed and manufactured to DIN 838

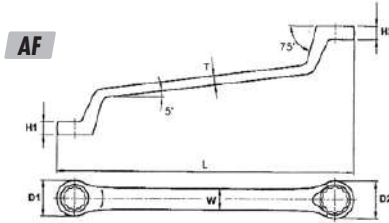

ITEM ID:	Size AF	L mm	H1 mm	H2 mm	D1 mm	D2 mm	T mm	 g
673032	1/4 x 5/16	168	5.6	6.3	10.7	12.2	4.1	45
673436	3/8 x 7/16	198	7.4	7.7	16.6	18	4.9	93
673840	1/2 x 7/16	217	8.1	7.7	19.5	20.9	5.4	135
674244	13/16 x 7/8	318	10.9	11.4	31.1	34	7.1	325
674648	15/16 x 1-1/16	347	12.4	13.4	36.9	40.5	8.1	475
675052	1 x 1-1/8	355	12.7	13.7	38.4	42.8	8.5	570
675456	1-1/8 x 1-1/4	362	14.4	15.2	45.5	48.5	9	650







### EXTRA LONG DOUBLE RING SPANNERS

- Metric long reach double ring spanner
- Flat design for use in confined spaces
- Different size at each end to give 2 sizes with one wrench
- Chrome vanadium satin finish
- TengTools hip grip design for contact with the flat side of the fastening
- Designed and manufactured to DIN837

mm



ITEM ID:	Size mm	L mm	A mm	B mm	C mm	D mm	g
630810FL	8x10	265	12.5	15	7.5	8.4	72
631113FL	11x13	328	17.8	20.3	10.4	11.3	155
631214FL	12x14	328	17.8	20.3	10.4	11.3	157
631618FL	16x18	408	23.4	26.3	12.8	14.4	284
631719FL	17x19	407	23.7	26.6	13	14.8	284
632224FL	22x24	430	31.3	34	15.4	17.7	482

### POCKET SIZED DOUBLE RING SPANNER

- The original TengTools Rigger Jigger
- 10 x 13mm double ring spanner
- Compact, angled heads and 12 point opening at each end
- The two most commonly used sizes in one handy tool
- Designed and manufactured to DIN3113A

mm

Item ID: 601013



### DOUBLE RING SPANNER SET

11 Pieces mm

- Different size at each end to give 22 sizes in total
- Double curved heads offset at 75° for easier use on flat surfaces
- Chrome vanadium satin finish
- TengTools hip grip design for contact with the flat side of the fastening
- Designed and manufactured to DIN838

Double Ring Spanners:

6x7, 8x9, 10x11, 12x13, 14x15, 16x17, 18x19, 20x22, 21x23, 24x27, 30x32 mm

Item ID: TTX6311



### EXTRA LONG DOUBLE RING SPANNER SET

6 Pieces mm

- Different size at each end to give 12 sizes in total
- Extra long, flat design for extra torque
- Chrome vanadium satin finish
- TengTools hip grip design for contact with the flat side of the fastening
- Designed and manufactured to DIN837

Extra long Double Ring Spanners:

8x10, 11x13, 12x14, 16x18, 17x19, 22x24 mm

Item ID: TTXFLS06

NEW



### DOUBLE RING SPANNER SET

7 Pieces AF

- Different size at each end to give 12 sizes in total
- Double curved heads offset at 75° for easier use on flat surfaces
- Chrome vanadium satin finish
- TengTools hip grip design for contact with the flat side of the fastening
- Designed and manufactured to DIN838

Double Ring Spanners:

1/4" x 5/16", 3/8" x 7/16", 7/16" x 1/2", 13/16" x 7/8", 15/16" x 1-1/16", 1" x 1-1/8", 1-1/8" x 1-1/4"

Item ID: TTX6707



8 Pieces **mm** **EVA**

### DOUBLE RING SPANNER SET

- Different size at each end to give 16 sizes in total
- Double curved heads offset at 75° for easier use on flat surfaces
- Chrome vanadium satin finish
- TengTools hip grip design for contact with the flat side of the fastening
- Tools are held in place using three colour pre-cut EVA foam
- Designed and manufactured to DIN838

Double Ring Spanners:

6x7, 8x9, 10x11, 12x13, 14x15, 16x17, 18x19, 20x22 mm

Item ID: **TEX6308**



6 Pieces **mm** **EVA**

### EXTRA LONG DOUBLE RING SPANNER SET

- Different size at each end to give 12 sizes in total
- Extra long, flat design for extra torque
- Chrome vanadium satin finish
- TengTools hip grip design for contact with the flat side of the fastening
- Tools are held in place using three colour pre-cut EVA foam
- Designed and manufactured to DIN837

Extra long Double Ring Spanners:

8x10, 11x13, 12x14, 16x18, 17x19, 22x24 mm

Item ID: **TEXFLS06**



5 Pieces **mm**

### LONG DOUBLE RING SPANNER SET

- Different size at each end to give 10 sizes in total
- Extra long, flat design for extra torque and easier access
- Chrome vanadium satin finish
- TengTools hip grip design for contact with the flat side of the fastening
- Supplied with a wall rack for fixing to the wall or a workbench

Extra long Double Ring Spanners:

8x10, 11x13, 12x14, 17x19, 22x24 mm

Item ID: **WRFLS05**



8 Pieces **mm**

### DOUBLE RING SPANNER SET

- Different size at each end to give 16 sizes in total
- Double curved heads offset at 75° for easier use on flat surfaces
- Chrome vanadium satin finish
- TengTools hip grip design for contact with the flat side of the fastening
- Designed and manufactured to DIN 838

Double Ring Spanners:

6x7, 8x9, 10x11, 12x13, 14x15, 16x17, 18x19, 20x22 mm

Item ID: **6308**



11 Pieces

mm

### DOUBLE RING SPANNER SET

- Different size at each end to give 22 sizes in total
- Double curved heads offset at 75° for easier use on flat surfaces
- Chrome vanadium satin finish
- TengTools hip grip design for contact with the flat side of the fastening
- Designed and manufactured to DIN 838

Double Ring Spanners:

6x7, 8x9, 10x11, 12x13, 14x15, 16x17, 18x19, 20x22, 21x23, 24x27, 30x32 mm

Item ID: 6311

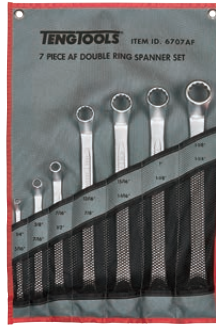

7 Pieces

AF

### DOUBLE RING SPANNER SET

- Different size at each end to give 22 sizes in total
- Double curved heads offset at 75° for easier use on flat surfaces
- Chrome vanadium satin finish
- TengTools hip grip design for contact with the flat side of the fastening
- Designed and manufactured to DIN838

Double Ring Spanners:

1/4"x5/16", 3/8"x7/16", 7/16"x1/2", 13/16"x7/8", 15/16"x1-1/16", 1"x1-1/8", 1-1/8"x1-1/4"

Item ID: 6707AF



8 Pieces

mm

### DOUBLE RING SPANNER SET

- Different size at each end to give 16 sizes in total
- Double curved heads offset at 75° for easier use on flat surfaces
- Chrome vanadium satin finish
- TengTools hip grip design for contact with the flat side of the fastening
- Supplied in a handy tool roll style wallet
- Designed and manufactured to DIN 838

Double Ring Spanners:

6x7, 8x9, 10x11, 12x13, 14x15, 16x17, 18x19, 20x22 mm

Item ID: 6308MM



### SPANNER RING

- Spanner ring with carabiner style snap hook
- Ideal for storing combination and double ring spanners
- Alternatively use as a belt hook for spanners with a ring end

Item ID: 600



## DOUBLE OPEN ENDED SPANNERS

- Different size at each end to give 2 sizes with one wrench
- Open at each end off set at 15° for easier use
- Chrome vanadium satin finish
- Designed and manufactured to DIN3110

mm



ITEM ID:	Size mm	L mm	H mm	D1 mm	D2 mm	T mm	Weight g
620607	6x7	123	3.7	18	15.5	3.7	25
620809	8x9	140	4	22.7	20.4	4	35
621011	10x11	156	5	27.1	24.9	5	50
621213	12x13	172	5.5	31.2	29.2	5.5	75
621415	14x15	188.5	5.9	35.3	33.3	5.9	105
621617	16x17	204	6.3	38.9	37.1	6.3	155
621819	18x19	221	6.7	42.8	40.9	6.7	190
622022	20x22	237	7.1	48.8	44.8	7.1	220
622123	21x23	247	7.7	50.8	46.8	7.7	245
622427	24x27	263	8.1	59.1	52.8	8.1	305
623032	30x32	298	9	69.8	65.4	9	465



Get organised!

Tray Size

TT			
----	--	--	--

8 Pieces mm

## DOUBLE OPEN ENDED SPANNER SET

- Different size at each end to give 16 sizes in total
- Open at each end off set at 15° for easier use
- Chrome vanadium satin finish
- Designed and manufactured to DIN3110

Double Open Ended Spanners:

6x7, 8x9, 10x11, 12x13, 14x15, 16x17, 18x19, 20x22 mm

Item ID: **TT6208**

## NEW DOUBLE OPEN ENDED SPANNERS

- Different size at each end to give 2 sizes with one wrench
- Open at each end off set at 15° for easier use
- Chrome vanadium satin finish
- Designed and manufactured to DIN3110

AF



ITEM ID:	Size mm	L mm	H mm	D1 mm	D2 mm	T mm	Weight g
663032	1/4 x 5/16	123	2.9	15.5	18	2.9	25
663436	3/8 x 7/16	156	3.4	24.9	27.1	3.4	61
663840	1/2 x 9/16	180	4	31.3	33.3	4	85
664244	5/8 x 3/4	221	4.6	37.1	42.8	4.6	160
664648	13/16 x 7/8	237	4.9	44.8	48.8	4.9	220
665052	15/16 x 1	255	5.3	50.8	56.8	5.3	298
665456	1-1/8 x 1-1/4	298	6	65.4	69.8	6	470



NEW



Get organised!

Tray Size

TTX			
-----	--	--	--

7 Pieces AF

## DOUBLE OPEN ENDED SPANNER SET

- Different size at each end to give 14 sizes in total
- Chrome vanadium satin finish
- TengTools hip grip design for contact with the flat side of the fastening
- Designed and manufactured to DIN 3110

Double Open Ended Spanners:

1/4" x 5/16", 3/8" x 7/16", 1/2" x 9/16", 5/8" x 3/4", 13/16" x 7/8", 15/16" x 1", 1-1/8" x 1-1/4"

Item ID: **TTX6607**



### DOUBLE OPEN ENDED SPANNER SET

8 Pieces

mm

- Different size at each end to give 16 sizes in total
- Open at each end off set at 15° for easier use
- Chrome vanadium satin finish
- Designed and manufactured to DIN3110 and DIN3113A

Double Open Ended Spanners:

6x7, 8x9, 10x11, 12x13, 14x15, 16x17, 18x19, 20x22 mm

Item ID: 6208



### DOUBLE OPEN ENDED SPANNER SET

11 Pieces

mm

- Different size at each end to give 22 sizes in total
- Open at each end off set at 15° for easier use
- Chrome vanadium satin finish
- Supplied in a handy tool roll style wallet
- Designed and manufactured to DIN3110 and DIN3113A

Double Open Ended Spanners:

6x7, 8x9, 10x11, 12x13, 14x15, 16x17, 18x19, 20x22, 21x23, 24x27, 30x32 mm

Item ID: 6211MM



### DOUBLE OPEN ENDED SPANNER SET

11 Pieces

mm

- Different size at each end to give 22 sizes in total
- Open at each end off set at 15° for easier use
- Chrome vanadium satin finish
- Designed and manufactured to DIN3110

Double Open Ended Spanners:

6x7, 8x9, 10x11, 12x13, 14x15, 16x17, 18x19, 20x22, 21x23, 24x27, 30x32 mm

Item ID: 6211

**NEW**



### DOUBLE OPEN ENDED SPANNER SET

7 Pieces

AF

- Different size at each end to give 14 sizes in total
- Chrome vanadium satin finish
- TengTools hip grip design for contact with the flat side of the fastening
- Designed and manufactured to DIN838

Double Open Ended Spanners:

1/4" x 5/16", 3/8" x 7/16", 1/2" x 9/16", 5/8" x 3/4",  
13/16" x 7/8", 15/16" x 1", 1-1/8" x 1-1/4"

Item ID: 6607AF



**DOUBLE FLEX WRENCHES**

- Swivel end wrench for fast pre-tightening and loosening
- 12 point socket at each end with 2 different sizes in one wrench
- Angle at 90° for added torque when applying the final tightening
- Extra torque for loosening stubborn fastenings
- Chrome vanadium satin finish
- Designed and manufactured to DIN standards

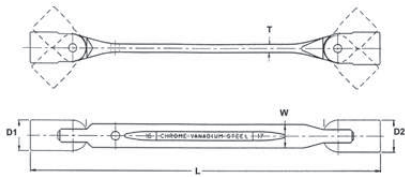

ITEM ID:	Sizes	L mm	D1 mm	D2 mm	W mm	T mm	g
611214	3/8"x7/16"	200	15.5	16.9	10	4.6	105
611618	1/2"x9/16"	218	18.2	19.2	12.5	5	150
612022	5/8"x11/16"	275	23	24.2	14	6.5	300
650809	8x9	192	12.2	13.5	10	4.6	95
651011	10x11	200	15.5	16.9	10	4.6	105
651013	10x13	213	14.5	18.2	12.5	5	140
651213	12x13	218	18.2	19.2	12.5	5	150
651415	14x15	243	20.5	21.7	14	5.8	215
651617	16x17	275	23	24.2	15	6.5	300
651819	18x19	284	25.5	26.7	16	7.5	382



**DOUBLE FLEX WRENCH SET**

- Swivel end wrenches for fast pre-tightening and loosening
- Angle at 90° for added torque when applying the final tightening
- Extra torque for loosening stubborn fastenings
- Chrome vanadium satin finish
- Designed and manufactured to DIN standard

Double Flex Wrenches
8x9, 10x11, 12x13, 14x15, 16x17, 18x19 mm

Item ID: **TT6506**



**DOUBLE FLEX WRENCH SET**



- Swivel end wrenches for fast pre-tightening and loosening
- Angle at 90° for added torque when applying the final tightening
- Extra torque for loosening stubborn fastenings
- Tools are held in place using three colour pre-cut EVA foam
- Designed and manufactured to DIN standard

Double Flex Wrenches
8x9, 10x11, 12x13, 14x15, 16x17, 18x19 mm
B-flex Wrench:
1/4" Male x 1/4" Hex Female

Item ID: **TEDDF7**



**DOUBLE FLEX WRENCH SET**



- Swivel end wrenches for fast pre-tightening and loosening
- Angle at 90° for added torque when applying the final tightening
- Extra torque for loosening stubborn fastenings
- Chrome vanadium satin finish
- Supplied with a wall rack for fixing to the wall or a workbench

Double Flex Wrenches
8x9, 10x11, 12x13, 14x15, 16x17, 18x19 mm

Item ID: **WRDF06**



### BI-FLEX WRENCH

- Swivel end wrench for fast pre-tightening and loosening
- 1/4" bit socket at one end to suit screwdriver bits
- 1/4" male drive on the other end to suit 1/4" drive sockets
- Angle at 90° for added torque
- Chrome vanadium satin finish
- Designed and manufactured to DIN standard

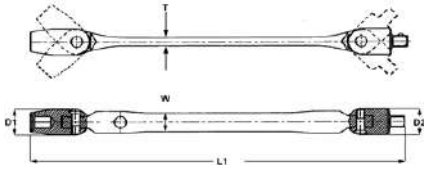

ITEM ID:	Sizes	L mm	D1 mm	D2 mm	W mm	T mm	g
691406	1/4" Hex x 1/4" M	196	14.5	14.5	10	4.6	102

### FLARE NUT WRENCHES

- Opening designed to allow use over pipes when tightening flare nuts
- Ideal for use on hydraulic systems on vehicles
- Also suitable for use on water pipe connections
- Different size at each end to give 2 sizes with one wrench
- Open at each end off set at 15° for easier use
- Chrome vanadium satin finish
- Designed and manufactured to DIN 3118



ITEM ID:	Sizes mm	L mm	H mm	D1 mm	D2 mm	C1 mm	C2 mm	T mm	g
641011	10x11	152.4	7.9	21.4	23	7	8.2	4.3	60
641213	12x13	178.6	10	25	27.4	9	10.3	5.7	113
641314	13x14	178.6	13.1	25	27.4	14.3	15.1	5.7	113
641617	16x17	196	15.1	29.9	31.9	15.4	17	6.4	113
641922	19x22	207.7	17	34.2	38.2	18.9	20	7.4	113
661416	7/16"x1/2"	158.8	11.9	23	24.3	8.2	9	5.5	113

### RATCHETING MULTI DRIVE RING SPANNERS

- Two size openings at each end
- 4 different spanner sizes in one handy tool
- TengTools hip grip design on the ring end for contact with the flat side of the fastening
- 72 teeth ratchet spanners giving a 5° increment between clicks
- Reversible ratchet mechanism with a flip reverse lever at each end
- Ideal for rapid tightening and loosening of fastenings
- Chrome vanadium satin finish



mm

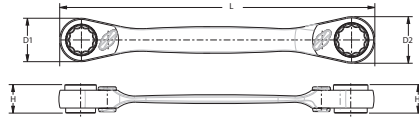

ITEM ID:	Sizes mm	L mm	D1 mm	D2 mm	g
60050811RX	8, 9, 10, 11	150	19.2	22	13.5
60051215RX	12, 13, 14, 15	190	25.5	28	18.4
60051619RX	16, 17, 18, 19	320	31.7	34	20.8



3 Pieces mm

### RATCHETING MULTI DRIVE SPANNER SET

- Two size openings at each end
- 4 different spanner sizes in one handy tool
- TengTools hip grip design on the ring end for contact with the flat side of the fastening
- 72 teeth ratchet spanners giving a 5° increment between clicks
- Reversible ratchet mechanism with a flip reverse lever at each end
- Ideal for rapid tightening and loosening of fastenings
- Chrome vanadium satin finish
- Supplied in a wallet bag

Multidrive Ring Spanners:

8x9x10x11, 12x13x14x15, 16x17x18x19 mm

Item ID: 6503RX



**MULTI DRIVE SPANNER REPAIR KITS**

- Replacement ratchet heads for the Ratcheting Multi Drive Ring Spanners

ITEM ID:	Service Kit For:	Size:
60050809RXRK	60050811RX	8x9
60051011RXRK	60050811RX	10x11
60051213RXRK	60051215RX	12x13
60051415RXRK	60051215RX	14x15
60051617RXRK	60051619RX	16x17
60051819RXRK	60051819RX	18x19

**RATCHETING OFFSET RING SPANNERS**

- Fibre reinforced reversible ratchet wrench
- 18 teeth for extra strength and use in outdoor sites
- Double ended with 25° offset heads
- 12 point ring ends
- Chrome vanadium satin finish with FRP body

mm

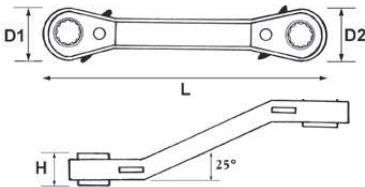

ITEM ID:	Sizes mm	L mm	H mm	D1 mm	D2 mm	g
680608	6x8	112	8	20	20	63
680709	7x9	133	8.4	21	23	81
681013	10x13	163	10.2	26	30	149
681214	12x14	172	10.2	30	32	169
681719	17x19	203	11	37	40	254
682122	21x22	235	11.4	41	45	290



**RATCHETING OFFSET RING SPANNER SET**

6 Pieces **mm**

- Fibre reinforced reversible ratchet wrenches
- 18 teeth for extra strength and use in outdoor sites
- Double ended with 25° offset heads
- 12 point ring ends (6x8mm is 6 point)
- Chrome vanadium satin finish with FRP bodies

RORS Wrenches
6x8, 7x9, 10x13, 12x14, 17x19, 21x22 mm

Item ID: TTRORS

**RATCHETING OFFSET TX-E WRENCH**

- Fibre reinforced reversible ratchet wrench
- 18 teeth for extra strength and use in outdoor sites
- Double ended with 25° offset heads
- For use with external TX fastenings
- Chrome vanadium satin finish with FRP body

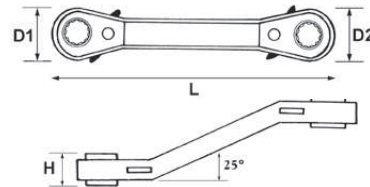

ITEM ID:	Sizes mm	L mm	H mm	D1 mm	D2 mm	g
680810E	E8xE10	133	8.2	21	23	84
681112E	E11xE12	140	8.2	23	26	95
681416E	E14xE16	172	10.2	30	32	174
681820E	E18xE20	203	11.5	37	40	280
682224E	E22xE24	235	11.5	41	44	330



### RATCHETING PODGER WRENCHES

- For use in construction
- Ideal for scaffolding, pallet racking, shelving systems and metal panel erection
- 2 sizes in one with 12 point double ended sockets
- 32 teeth for extra strength and use in outdoor sites
- Flip reverse for quickly changing between tightening and loosening
- Tapered podger style handle for aligning holes prior to fixing
- Hole in the handle for use with a fall protection wire

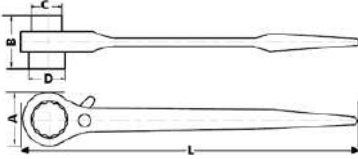

ITEM ID:	Sizes mm	L mm	A mm	B mm	C mm	D mm	g
PGW1719	17 x 19	315	42	50	26	26.3	450
PGW1922	19 x 22	315	42	50	26	29.5	450
PGW1924	19 x 24	315	42	50	26	32	469
PGW2124	21 x 24	315	42	50	28	32	462
PGW2430	24 x 30	450	63	63	32	40	1332
PGW2730	27 x 30	366	65	63	36.6	40	1350

### QUICK WRENCHES

- Special design for loosening and tightening pipe and hose couplings
- Ideal for use in confined spaces
- Ring end opens up easily to access the nut on the coupling

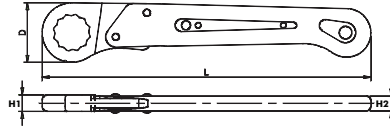

ITEM ID:	Size mm	L mm	D mm	H1 mm	H2 mm	g
600813	13	141	27.5	7.2	8	92
600814	14	191	35.7	10	9	165
600816	16	191	35.7	10	9	165
600817	17	191	35.7	10	9	180
600819	19	191	35.7	10	9	225
600822	22	233	40.7	13	12	294
600824	24	235	43.2	13	12	300
600827	27	325	54.2	14.1	14.4	625
600830	30	325	56.4	15.9	14.4	610
600832	32	325	58.5	15.9	14.4	625



Get organised

Tray Size
TTX

### QUICK WRENCH SET

**7** Pieces **mm**

- Special design for loosening and tightening pipe and hose couplings
- Ideal for use in confined spaces
- Ring end has a clever design so that it opens up easily to access the nut on the coupling

Quick Wrenches
13, 17, 19, 22, 24, 27, 32 mm

Item ID: **TTXQRS07**

**HOOK WRENCHES**

- Suitable for use with locking nuts and bearing carriers
- Chrome vanadium satin finish
- Designed to fit locking nuts according to DIN 1804
- Designed and manufactured to DIN 1810



ITEM ID:	Capacity mm	Capacity AF	Length mm	Length AF	 g
HP101	19 to 50	3/4" to 2"	145	5-3/4"	122
HP102	32 to 75	1-1/4" to 3"	178	7"	234
HP103	50 to 120	2" to 4-3/4"	247	9-3/4"	447

**PIN WRENCHES**

- Suitable for use with locking nuts and bearing carriers
- Chrome vanadium satin finish
- Designed to fit locking nuts according to DIN 1816
- Designed and manufactured to DIN 1810



ITEM ID:	Pin Size mm	Capacity mm	Length mm	Length AF	 g
HP2014	4	19 to 50	145	5-3/4"	122
HP2015	5	19 to 50	145	5-3/4"	122
HP2025	5	32 to 75	178	7"	227
HP2026	6	32 to 75	178	7"	227
HP2036	6	50 to 120	247	9-3/4"	451
HP2038	8	50 to 120	247	9-3/4"	451



**8**  
Pieces

**HOOK AND PIN WRENCH SET**

- Includes a range of handles, pin and hook adaptors
- Chrome vanadium satin finish
- To be used for nuts designed and manufactured to DIN1804 & 1816
- Wrench manufactured to DIN1810

Hook & Pin Wrenches	
Hook Handles:	3/4" to 2", 1-1/4" to 3", 2" to 4-3/4"
Pin Adaptors:	4, 5, 6 mm
Pins:	6, 8 mm

Item ID: **TTHP08**

**REPLACEMENT PINS**

- Replacement pins for TengTools pin wrenches

ITEM ID:	Suitable For:
HP2014-P	HP2014 pin wrench
HP2015-P	HP2015 & HP2025 pin wrenches
HP2026-P	HP2026 pin wrench
HP2036-P	HP2036 pin wrench
HP2038-P	HP2038 pin wrench







### RING TYPE SLOGGING WRENCHES

- Designed for extra heavy duty work
- For use with a hammer or sledge hammer
- Manufactured in impact resistant Chrome molybdenum
- Designed and manufactured to DIN 7444

mm

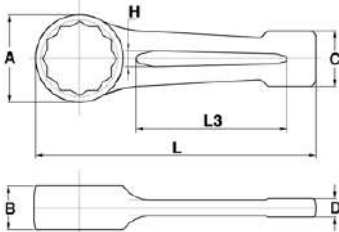

ITEM ID:	Size mm	L mm	A mm	B mm	C mm	D mm	L3 mm	H mm	g
903024	24	162	42.8	14.7	24.6	7.9	93.9	9.4	248
903027	27	180	45.2	15.4	25	8.6	107.3	9.4	260
903030	30	190	50.6	16.2	29.4	9.3	107.3	11.5	376
903032	32	190	53.7	16.4	31.7	10	107.3	12.3	480
903036	36	205	58.3	17.9	35.6	10.5	107.3	13.3	520
903038	38	229	63.7	19.9	36.9	12	130.3	13.3	660
903041	41	230	63.9	19.9	37.4	12.3	130.3	13.3	780
903046	46	240	73.5	21.8	43.9	12.5	130.9	14.5	1150
903050	50	255	78.5	23.2	46.3	13	134.5	17	1070
903055	55	266	85.1	25	49.4	15.5	141.2	19.3	1350
903060	60	280	91.7	26.5	52.2	16.5	150	22.7	1650
903065	65	298	100	27.5	54	16.5	150	23.2	1890
903070	70	330	109.5	32.8	62	20	165	24.6	2850
903075	75	330	110	32.8	62.2	20	154	24.6	2700
903080	80	355	129.4	37	82.3	23.8	170	40	3400
903085	85	355	129.5	37.3	82	23.4	170	40	4100
903090	90	395	143.5	40	72.7	24.2	170	47.5	5200
903095	95	390	144	37.1	72.8	20.8	165	47.5	5100
903100	100	420	155	41.6	80	23.6	175	50	6700

### OPEN ENDED SLOGGING WRENCHES

- Designed for extra heavy duty work
- For use with a hammer or sledge hammer
- Manufactured in impact resistant Chrome molybdenum
- Designed and manufactured to DIN 133

mm

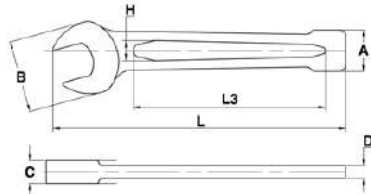

ITEM ID:	Size mm	L mm	A mm	B mm	C mm	D mm	L3 mm	H mm	g
902024	24	178	52.3	14.5	23.4	7.8	107.5	10.2	250
902027	27	180	55	15.5	25.2	8.6	107.5	10.2	350
902030	30	190	60.4	16.2	30	9.5	107.5	15.6	500
902032	32	190	60.5	16.7	30.5	9.8	108	14.8	480
902036	36	214	71.3	17	35	9.8	118	14.9	700
902038	38	215	72	17.3	37	9.8	118	16.2	750
902041	41	233	82.4	19.2	39.3	12	127.6	18.3	900
902046	46	252	93.2	20.4	44.2	12.8	135.6	18.8	1300
902050	50	275	104	21.3	48	13.2	140.8	19.6	1500
902055	55	295	114.4	23.8	54.2	15.3	158.6	24.2	1950
902060	60	315	125.1	26.6	58.8	17.3	166.2	24.8	2500
902065	65	340	138	28.8	55	17.6	175	25.1	3300
902070	70	370	152.7	30.6	69	19	190	32	4300
902075	75	370	152.7	31	69	19	190	33.4	4700
902080	80	397	175	33.2	71.5	19	180	46.6	5500
902085	85	397	175	33.2	71.5	19	180	46.6	5200
902090	90	444	191	34.7	80	19.6	190	51.7	7000
902095	95	444	191.3	36.3	80	21	190	52.2	6600
902100	100	488	225	42.3	85	21.8	205	55.5	10500





# ADJUSTABLE WRENCHES

## INCREASE YOUR EFFICIENCY

Our range includes the classic model in eight sizes with a capacity up to 70 mm, the ergonomic model with a comfortable handle in five sizes, the adjustable wrench with extra wide opening and one model with a pipe grip at the end.

Moving jaw does not protrude allowing use in confined spaces

Integral measurement scale on the jaw to easily see the nut size while using

Durable high grade chrome vanadium steel with a black phosphate finish

Bi-material handle for maximum comfort and strength

Designed and manufactured to: DIN 3117 and ISO 6787

Hole in the handle for tool securing with fall protection equipment



WIDE JAW ALSO AVAILABLE



METAL HANDLE ALSO AVAILABLE





### ADJUSTABLE WRENCHES

- Integral measurement scale on the jaw
- Moving jaw does not protrude allowing use in confined spaces
- Hole in the handle for tool securing when working at height
- High grade chrome vanadium steel with a black phosphate finish
- Designed and manufactured to: DIN 3117 and ISO 6787

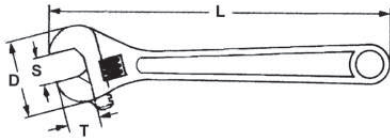

ITEM ID:	L mm	L AF	Capacity		T mm	D mm	ISO Nm	🏋️ g
			mm	AF				
4001	100	4"	17	11/16"	14	31	33	50
4002	150	6"	24	15/16"	19	44	85	140
4003	200	8"	28	1-1/8"	26	57	180	260
4004	250	10"	33	1-1/4"	31	68	320	440
4005	300	12"	38	1-1/2"	32	80	515	660
4006	375	15"	50	1-5/16"	44	100	920	1200
4007	450	18"	60	2-3/8"	53	122	1370	2000
4008	600	24"	70	2-3/4"	62	144	-	3700

### ADJUSTABLE WRENCHES

- Integral measurement scale on the jaw
- Moving jaw does not protrude allowing use in confined spaces
- Bi-material handle for extra comfort
- Hole in the handle for tool securing when working at height
- High grade chrome vanadium steel with a black phosphate finish
- Designed and manufactured to: DIN 3117 and ISO 6787

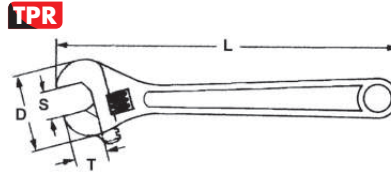

ITEM ID:	L mm	L AF	Capacity		T mm	D mm	ISO Nm	🏋️ g
			mm	AF				
4002IQ	157	6"	24	15/16"	20	52	85	140
4003IQ	206	8"	28	1-1/8"	25.3	62	180	260
4004IQ	255	10"	33	1-1/4"	29.5	72	320	440
4005IQ	305	12"	38	1-1/2"	32.2	83	515	660
4006IQ	380	15"	50	1-15/16"	44.7	108	920	1200



### ADJUSTABLE WRENCH SERVICE KITS

- Includes replacement pin, knurl and spring

ITEM ID:	Service Kit For:
4001RK	4" adjustable wrench - 4001
4002RK	6" adjustable wrench - 4002
4003RK	8" adjustable wrench - 4003
4004RK	10" adjustable wrench - 4004
4005RK	12" adjustable wrench - 4005
4006RK	15" adjustable wrench - 4006
4007RK	18" adjustable wrench - 4007
4008RK	24" adjustable wrench - 4008



### ADJUSTABLE WRENCH SERVICE KIT

- Includes replacement pin, knurl and spring

ITEM ID:	Service Kit For:
4002IQRK	6" adjustable wrench - 4002IQ
4003IQRK	8" adjustable wrench - 4003IQ
4004IQRK	10" adjustable wrench - 4004IQ
4005IQRK	12" adjustable wrench - 4005IQ
4006IQRK	15" adjustable wrench - 4006IQ

**WIDE JAW ADJUSTABLE WRENCHES**

- Integral measurement scale
- Extra wide jaw opening increases the bolt sizes that can be worked on
- Moving jaw does not protrude allowing use in confined spaces
- Bi-material handle for extra comfort
- Hole in the handle for tool securing when working at height
- High grade chrome vanadium steel with a black phosphate finish
- Designed and manufactured to: DIN 3117 and ISO 6787



**TPR**

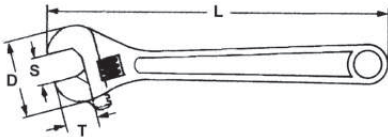

ITEM ID:	L mm	L AF	Capacity		T mm	D mm	 g
			mm	AF			
4002WT	172	7"	34	1-3/8"	30	63.5	185
4003WT	221	8"	38.6	1-1/2"	34.1	72.1	260
4004WT	275	10"	50	2"	41	92.1	440
4005WT	317	12"	60	2-3/8"	55.7	110.5	660



**ADJUSTABLE WRENCH SERVICE KIT**

- Includes replacement pin, knurl and spring

ITEM ID:	Service Kit For:
4002WTRK	6" adjustable wrench - 4002WT
4003WTRK	8" adjustable wrench - 4003WT
4004WTRK	10" adjustable wrench - 4004WT
4005WTRK	12" adjustable wrench - 4005WT

**"ALLIGATOR" ADJUSTABLE WRENCH**

- 8" (200mm) adjustable wrench
- Integral measurement scale on the jaw
- Moving jaw does not protrude allowing use in confined spaces
- Incorporates an "alligator" style pipe grip for gripping round objects
- Hole in the handle for tool securing when working at height
- High grade chrome vanadium steel with a black phosphate finish
- Designed and manufactured to: ISO6787, ASME B.107.8M, DIN3117, BS6333, JISB4604 and SABS1211



Item ID: **4003J**

Service Kit:

4003JRK



4 Pieces **TPR**

**ADJUSTABLE WRENCH SET**

- Includes an 8" wide jaw adjustable wrench for added versatility
- Designed and manufactured to DIN3117 and ISO6787

Adjustable Wrenches	
6" (150 mm)	Capacity: 23.9 mm
8" (200 mm)	Capacity: 28.6 mm
10" (250 mm)	Capacity: 32.8 mm
8" (200 mm) Wide Jaw	Capacity: 38.6 mm

Item ID: **TTADJ04**



4 Pieces **EVA** **TPR**

**ADJUSTABLE WRENCH SET**

- Includes regular style 6, 8 and 10" adjustable wrenches
- Also includes an 8" wide jaw adjustable wrench for added versatility
- Tools are held in place using three colour pre-cut EVA foam
- Designed and manufactured to DIN3117 and ISO6787

Adjustable Wrenches	
6" (150 mm)	Capacity: 23.9 mm
8" (200 mm)	Capacity: 28.6 mm
10" (250 mm)	Capacity: 32.8 mm
8" (200 mm) Wide Jaw	Capacity: 38.6 mm

Item ID: **TEDADJ4**

# SCREWDRIVERS

MORE **COMFORT** MORE **POWER**

Unlike other brands the Teng Tools screwdriver blade has steel alloy wings that the plastic handle is moulded around. This allows for greater torque to be put on the screwdriver, ensures the blade is dead straight and stops the blade from moving in the handle.



## What type of handle do I need?

The larger type of handle allows for more power and force to be executed with the driver.



The smaller type of handle make it easier to work quickly as less force is required with the driver.



## What type of shaft should I choose?



**Round Shaft**  
For extra speed



**HEX Shaft**  
For extra torque

The round shaft is smooth for rapid hand movement and a spanner can be used on a hexagonal shaft for adding extra torque.





Size and tip marked at the bottom of each handle for easy identification

Hole in the handle can be used in a fall arrest system, for storage and for use as a T-handle

The bi-material handle is designed for increased comfort and smooth action preventing blisters after continuous use. It gives better support and increased power transfer.

The soft black material prevents the screwdriver from sticking in the hand allowing for rapid movement

The red resistant plastic is used for the core and ensures the blade is held securely

Size marked on shaft for identification while in use

Shaft made from TengTools TT-MV PLUS steel alloy for greater strength and material flexibility

Magnetic tip designed to maximise torque transfer and reduce wear

Designed and manufactured to DIN5264





## MINI SCREWDRIVERS - FLAT TIP

- CrMo steel alloy for greater strength
- Rotating end piece for easier use when "transporting" the fastening

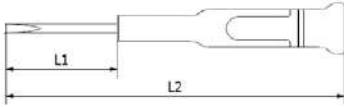

ITEM ID:				L1 mm	L2 mm	g
MDM713	2	Round	Parallel	40	122	12
MDM714	2.4	Round	Parallel	40	122	12
MDM715	3	Round	Parallel	40	122	12

## MINI SCREWDRIVERS - TX TIP

- CrMo steel alloy for greater strength
- Rotating end piece for easier use when "transporting" fastening

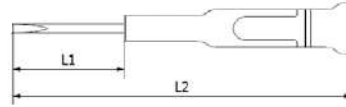

ITEM ID:				L1 mm	L2 mm	g
MDM806	TX6	Round	TX	40	122	12
MDM807	TX7	Round	TX	40	122	12
MDM808	TX8	Round	TX	40	122	12
MDM809	TX9	Round	TX	40	122	12
MDM810	TX10	Round	TX	40	122	12
MDM815	TX15	Round	TX	40	122	12

## MINI SCREWDRIVERS - PH TIP

- CrMo steel alloy for greater strength
- Rotating end piece for easier use when "transporting" fastening

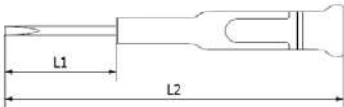

ITEM ID:				L1 mm	L2 mm	g
MDM716	PH00	Round	Phillips	40	122	12
MDM717	PH0	Round	Phillips	40	122	12
MDM718	PH1	Round	Phillips	40	122	12

## MINI SCREWDRIVERS - HEX TIP

- CrMo steel alloy for greater strength
- Rotating end piece for easier use when "transporting" fastening

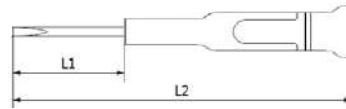



ITEM ID:				L1 mm	L2 mm	g
MDM711	2	Round	Hex	40	122	12
MDM712	2.5	Round	Hex	40	122	12

	Shaft Type		Handle Type
	Tip Type		Weight



**MINI PLIERS & SCREWDRIVER SET**

- Mini screwdrivers feature a rotating end piece for easier use when "transporting" the fastening
- Mini pliers feature high carbon steel construction and vinyl grip handles



MINI SCREWDRIVER:			
 mm:	2.0 x 40	2.4 x 40	3.0 x 40
 mm:	PH00 x 40	PH0 x 40	PH1 x 40
 mm:	TX6 x 40	TX7 x 40	TX8 x 40
	TX9 x 40	TX10 x 40	TX15 x 40
MINI PLIERS:			
4 1/2"			SIDE CUTTER
4 1/2"			END CUTTER
5"			LONG NOSE PLIER
5"			FLAT NOSE PLIER

Item ID: TTM116



**MINI SCREWDRIVER SET**

- CrMo steel alloy for greater strength
- Rotating end piece for easier use when "transporting" the fastening
- Supplied in a handy holder that can be wall mounted or used as a stand

MINI SCREWDRIVER:			
 mm:	2.0x40	2.4x40	3.0x40
 mm:	PH00x40	PH0x40	PH1x40

Item ID: MDM706



**MINI TX SCREWDRIVER SET**

- CrMo steel alloy for greater strength
- Rotating end piece for easier use when "transporting" the fastening
- Supplied in a handy holder that can be wall mounted or used as a stand















MINI SCREWDRIVER:			
 mm:	TX6 x 40	TX7 x 40	TX8 x 40
	TX9 x 40	TX10 x 40	TX15 x 40

Item ID: MDM706TX



**DOUBLE ENDED MINI SCREWDRIVER BLADES**

- Mini screwdriver handle
- For use with double ended mini screwdriver blades
- Twist grip tightening function allows the blade to be set at different lengths, ideal for where access is restricted
- Rotating end piece for easier use when "transporting" the fastening

ITEM ID:	TIP 1	SIZE 1	TIP 2	SIZE 2
MDM700	MINI SCREWDRIVER BLADE HANDLE			
2912512		PH00		2
2912513		PH00		3
2912514		PH1		4
2912520		P20		P21
2912535		TX5		TX7
2912537		TX6		TX8
2912539		TX9		TX10



## MINI SCREWDRIVER SET



- Includes fully interchangeable double ended blades
- Sizes clearly marked on the shaft
- Hexagon shaft
- Twist grip tightening function allows the blade to be set at different lengths, ideal for where access is restricted
- Rotating end piece for easier use when "transporting" the fastening

MINI SCREWDRIVER BLADE HANDLE			
SCREWDRIVER BLADES:			
		mm:	PH00 - 2.0 PH0 - 3.0 PH1 - 4.0
			PZ0 - PZ1
			TX5 - TX7 TX6 - TX8 TX9 - TX10

Item ID: **TM708**

## MINI T-HANDLE SCREWDRIVERS - TX TIP

- CrMo steel alloy for greater strength
- Rotating end piece for easier use when "transporting" the fastening



ITEM ID:			
			g
MDM806T	TX6	TX	10
MDM807T	TX7	TX	10
MDM808T	TX8	TX	10
MDM809T	TX9	TX	15
MDM810T	TX10	TX	15
MDM815T	TX15	TX	15



## MINI TX T-HANDLE SCREWDRIVER SET

- Especially designed bi-material handle for easier use
- Rotating end piece for easier use when "transporting" the fastening
- Supplied in a handy holder that can be wall mounted

MINI T HANDLE SCREWDRIVER:		
	TX6	TX7
	TX8	TX9
	TX10	TX15

Item ID: **MDM706TXT**

## SCREWDRIVER WITH POCKET CLIP

- TT-MV PLUS steel alloy for greater strength and material flexibility
- Ergonomically designed bi-material handle for easy use with higher torque and faster speed
- Pocket clip
- Hole in the handle for hanging or for use with a fall protection wire if needed
- The handle is moulded around the blade to ensure straightness and to allow larger blade wings which give a higher torque capacity

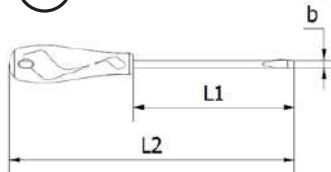





ITEM ID:	b	L1	L2	
	mm	mm	mm	g
MDMC718N	3	50	120	12

	Shaft Type		Handle Type
	Tip Type		Weight

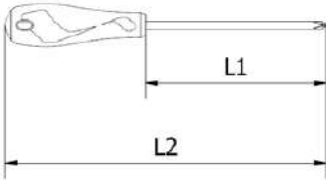
**SCREWDRIVER WITH POCKET CLIP**

- TT-MV PLUS steel alloy for greater strength and material flexibility
- Ergonomically designed bi-material handle for easy use with higher torque and faster speed
- Pocket clip
- Hole in the handle for hanging or for use with a fall protection wire if needed
- The handle is moulded around the blade to ensure straightness and to allow larger blade wings which give a higher torque capacity
- DIN ISO 8764





ITEM ID:			L1 mm	L2 mm	 g
MDMC715N	PH1	Phillips	50	120	12



**SCREWDRIVER SET WITH POCKET CLIPS**

- TT-MV PLUS steel alloy for greater strength and material flexibility
- Ergonomically designed bi-material handles for easy use with higher torque and faster speed
- Pocket clip
- Hole in the handle for hanging or for use with a fall protection wire if needed
- The handle is moulded around the blade to ensure straightness and to allow larger blade wings which give a higher torque capacity

SCREWDRIVERS:		
	mm:	3 x 50
	mm:	PH1 x 50

Item ID: MDMC702N



# DO'S & DONT'S SCREWDRIVERS

-  Use the right tip
-  Keep it clean & dry
-  Apply extra torque correctly
-  Choose the right handle
-  Do not use the wrong tip
-  Do not use the screwdriver as a lever
-  Do not use on live electrics
-  Do not use too much power





## CHOOSE THE RIGHT HANDLE FOR THE RIGHT TASK

A larger type of handle allows for more power and force to be executed with the driver while a smaller type of handle make it easier to work quickly as less force is required with the driver.



Shaft Type    Handle Type  
 Tip Type    Weight

## SCREWDRIVERS - FLAT TIP

- TT-MV PLUS steel alloy for greater strength and material flexibility
- Ergonomically designed bi-material handle for easy use with higher torque and faster speed
- Hole in the handle for hanging or for use as a T handle for extra torque or with a fall protection wire if needed
- The handle is moulded around the blade to ensure straightness and to allow larger blade wings which give a higher torque capacity
- Designed and manufactured to DIN5264.

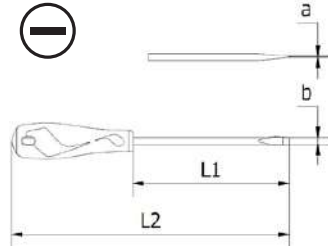



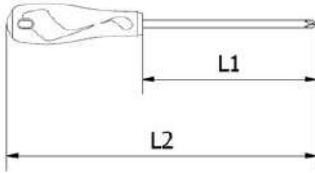

ITEM ID:	a mm	b mm			L1 mm	L2 mm	g	
MD914N	0.4	2.5	Round	Parallel	50	146	24	S
MD915N	0.5	2.5	Round	Parallel	75	171	24	S
MD915N1	0.5	2.5	Round	Parallel	200	296	25	S
MD920N	0.5	3	Round	Parallel	75	171	27	S
MD920N1	0.5	3	Round	Parallel	100	196	31	S
MD916N	0.6	3.5	Round	Parallel	75	171	29	S
MD916N1	0.6	3.5	Round	Parallel	100	196	31	S
MD916N2	0.6	3.5	Round	Parallel	150	246	38	S
MD917N	0.8	4	Round	Parallel	100	196	31	S
MD917N1	0.8	4	Round	Parallel	400	496	41	S
MD917N2	0.8	4	Round	Parallel	150	246	38	S
MD922N	1	5.5	Round	Flared	75	246	38	S
MD923N	1	5.5	Round	Flared	150	258	64	M
MD923N1	1	5.5	Round	Flared	200	308	74	M
MD928N	1.2	6.5	Round	Flared	38	96	45	XS
MD928N1	1.2	6.5	Round	Flared	100	216	93	L
MD928N2	1.2	6.5	Round	Flared	150	266	105	L
MD928N3	1.2	6.5	Round	Flared	200	316	115	L
MD928N4	1.2	6.5	Round	Flared	100	208	105	M
MD928N5	1.2	6.5	Round	Flared	150	258	110	M
MD928N6	1.2	6.5	Round	Flared	200	308	113	M
MD928N7	1.2	6.5	Round	Flared	400	508	185	M
MD930N	1.6	10	Round	Flared	200	325	231	XL
MD931N	1	5.5	Hex	Flared	125	253	96	L
MD932N	1.2	6.5	Hex	Flared	100	216	101	L
MD932N1	1.2	6.5	Hex	Flared	150	266	114	L
MD932N2	1.2	6.5	Hex	Flared	400	516	181	L
MD934N	1.2	8	Hex	Flared	150	275	156	XL
MD935N	1.6	10	Hex	Flared	200	325	226	XL

**SCREWDRIVERS - PH TIP**

- TT-MV PLUS steel alloy for greater strength and material flexibility
- Ergonomically designed bi-material handle for easy use with higher torque and faster speed
- Hole in the handle for hanging or for use as a T handle for extra torque or with a fall protection wire if needed
- The handle is moulded around the blade to ensure straightness and to allow larger blade wings which give a higher torque capacity
- Designed and manufactured to DIN ISO 8764





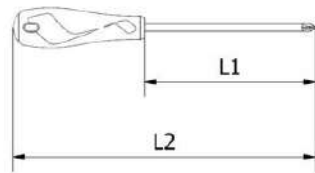

ITEM ID:				L1 mm	L2 mm	 g	
MD940N	PH0	Round	Phillips	75	171	27	S
MD940N1	PH0	Round	Phillips	300	396	41	S
MD947N	PH1	Round	Phillips	38	96	40	XS
MD947N1	PH1	Round	Phillips	75	183	29	M
MD947N2	PH1	Round	Phillips	150	258	61	M
MD948N	PH2	Round	Phillips	38	96	46	XS
MD948N1	PH2	Round	Phillips	100	216	93	L
MD948N2	PH2	Round	Phillips	200	316	115	L
MD948N3	PH2	Round	Phillips	400	516	153	L
MD948N4	PH2	Round	Phillips	100	208	90	M
MD948N5	PH2	Round	Phillips	200	308	110	M
MD948N6	PH2	Round	Phillips	400	508	148	M
MD948N8	PH2	Round	Phillips	300	408	114	M
MD949N	PH3	Round	Phillips	150	275	152	XL
MD950N	PH4	Round	Phillips	200	325	261	XL
MD952N	PH2	Hex	Phillips	100	216	101	L
MD952N1	PH2	Hex	Phillips	400	516	181	L
MD953N	PH3	Hex	Phillips	150	275	159	XL
MD954N	PH4	Hex	Phillips	200	325	231	XL

**SCREWDRIVERS - PZ TIP**

- TT-MV PLUS steel alloy for greater strength and material flexibility
- Ergonomically designed bi-material handle for easy use with higher torque and faster speed
- Hole in the handle for hanging or for use as a T handle for extra torque or with a fall protection wire if needed
- The handle is moulded around the blade to ensure straightness and to allow larger blade wings which give a higher torque capacity
- Designed and manufactured to DIN ISO 8764



ITEM ID:				L1 mm	L2 mm	 g	
MD960N	PZ0	Round	Pozi	75	171	27	S
MD961N	PZ1	Round	Pozi	75	183	29	M
MD961N1	PZ1	Round	Pozi	250	358	73	M
MD961N2	PZ1	Round	Pozi	38	96	40	XS
MD962N	PZ2	Round	Pozi	100	216	93	L
MD962N1	PZ2	Round	Pozi	150	266	105	L
MD962N2	PZ2	Hex	Pozi	100	216	101	L
MD962N3	PZ2	Round	Pozi	38	96	45	XS
MD962N4	PZ2	Round	Pozi	100	208	98	M
MD962N5	PZ2	Round	Pozi	150	258	100	M
MD962N4A	PZ2	Round	Pozi	200	308	93	M
MD962N4C	PZ2	Round	Pozi	300	408	93	M
MD962N4D	PZ2	Round	Pozi	400	508	93	M
MD963N	PZ3	Hex	Pozi	150	275	158	XL
MD964N	PZ4	Hex	Pozi	200	325	231	XL





### SCREWDRIVERS - TX TIP

- TT-MV PLUS steel alloy for greater strength and material flexibility
- Ergonomically designed bi-material handle for easy use with higher torque and faster speed
- Hole in the handle for hanging or for use as a T handle for extra torque or with a fall protection wire if needed
- The handle is moulded around the blade to ensure straightness and to allow larger blade wings which give a higher torque capacity

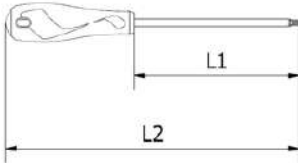

ITEM ID:				L1 mm	L2 mm		
MD906TN	TX6	Round	TX	75	171	29	S
MD907TN	TX7	Round	TX	75	171	29	S
MD908TN	TX8	Round	TX	75	171	29	S
MD909TN	TX9	Round	TX	75	171	29	S
MD910TN	TX10	Round	TX	100	208	58	M
MD915TN	TX15	Round	TX	100	208	58	M
MD920TN	TX20	Round	TX	100	208	58	M
MD925TN	TX25	Round	TX	100	216	93	L
MD927TN	TX27	Round	TX	100	216	94	L
MD930TN	TX30	Round	TX	100	216	94	L
MD940TN	TX40	Round	TX	100	216	106	L
MD945TN	TX45	Round	TX	125	250	237	XL

### SCREWDRIVERS - TPX TIP

- For use with tamper proof TX fastenings
- TT-MV PLUS steel alloy for greater strength and material flexibility
- Ergonomically designed bi-material handle for easy use with higher torque and faster speed
- Hole in the handle for hanging or for use as a T handle for extra torque or with a fall protection wire if needed
- The handle is moulded around the blade to ensure straightness and to allow larger blade wings which give a higher torque capacity

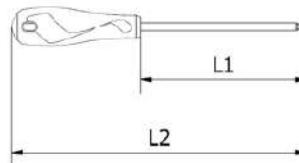

ITEM ID:				L1 mm	L2 mm		
MD610TPN	TPX10	Round	TPX	100	208	58	M
MD615TPN	TPX15	Round	TPX	100	208	58	M
MD620TPN	TPX20	Round	TPX	100	208	58	M
MD625TPN	TPX25	Round	TPX	100	216	94	L
MD627TPN	TPX27	Round	TPX	100	216	94	L
MD630TPN	TPX30	Round	TPX	100	216	94	L
MD640TPN	TPX40	Round	TPX	100	216	105	L

### HEX SCREWDRIVERS

- For use with hexagon fastenings and grub screws
- TT-MV PLUS steel alloy for greater strength and material flexibility
- Ergonomically designed bi-material handle for easy use with higher torque
- Hole in the handle for hanging or for use as a T handle for extra torque
- The handle is moulded around the blade to ensure straightness

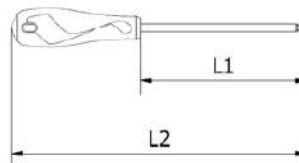

ITEM ID:				L1 mm	L2 mm
MD7020HN	2	Round	Hex	100	196
MD7025HN	2.5	Round	Hex	100	196
MD7030HN	3	Round	Hex	100	196

Shaft Type    Handle Type  
 Tip Type    Weight

**HEX SCREWDRIVERS**

- Ball point head allows turning at angles up to 25° for easier access
- For use with hexagon fastenings and grub screws
- TT-MV PLUS steel alloy for greater strength and material flexibility
- Ergonomically designed bi-material handle for easy use with higher torque
- Hole in the handle for hanging or for use as a T handle for extra torque
- The handle is moulded around the blade to ensure straightness

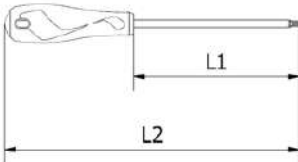

ITEM ID:				L1 mm	L2 mm
MD7020HBN	2	Round	Hex ball	100	196
MD7025HBN	2.5	Round	Hex ball	100	196
MD7030HBN	3	Round	Hex ball	150	246
MD7040HBN	4	Round	Hex ball	150	258
MD7050HBN	5	Round	Hex ball	150	266
MD7060HBN	6	Round	Hex ball	150	266
MD7080HBN	8	Round	Hex ball	150	275

**SCREWDRIVERS - ROB TIP**

- TT-MV PLUS steel alloy for greater strength and material flexibility
- Ergonomically designed bi-material handle for easy use with higher torque and faster speed
- Hole in the handle for hanging or for use as a T handle for extra torque or with a fall protection wire if needed
- The handle is moulded around the blade to ensure straightness and to allow larger blade wings which give a higher torque capacity

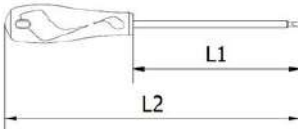

ITEM ID:				L1 mm	L2 mm	g	
MD801N	1	Round	ROB	100	216	94	L
MD802N	2	Round	ROB	100	216	94	L
MD803N	3	Round	ROB	100	216	94	L

**DOUBLE ENDED BLADES**

- Double ended screwdriver blade giving two tools in one
- Hexagon shaft enabling a wrench to be used for added control and torque
- TT-MV PLUS steel alloy for greater strength and material flexibility
- Sizes clearly marked on the shaft

ITEM ID:	TIP 1	SIZE 1	TIP 2	SIZE 2
MD901	SCREWDRIVER BLADE HANDLE			
PZZ0102		PZ1		PZ2
PHH0102		PH1		PH2
FTF4055		4		5.5
PHF0365		PH3		6.5
TXX1015		TX10		TX15
TXX2025		TX20		TX25
TXX3040		TX30		TX40
HBH0303		3 Ball		3
HBH0404		4 Ball		4
HBH0505		5 Ball		5
HBH0606		6 Ball		6



**SCREWDRIVER BLADE SET**

- 22 screwdrivers in one set
- TT-MV PLUS steel alloy for greater strength and material flexibility
- Ergonomically designed bi-material handle for easy use with higher torque
- Hanging hole in the handle for use as a T handle or with a fall protection wire

SCREWDRIVER BLADE HANDLE WITH 1/4" SHANK					
SCREWDRIVER BLADES:					
	mm:	4 - 5.5			
		PH1 - PH2			
	mm:	PH3 - 6.5			
		PZ1 - PZ2			
	mm:	3 Ball - 3	4 Ball - 4	5 Ball - 5	6 Ball - 6
	TX:	10 - 15	20 - 25	30 - 40	

Item ID: TTMD12D



## POWER THROUGH SCREWDRIVERS - FLAT TIP

- Percussion cap and power through blade for striking with a hammer
- Ergonomically designed bi-material handle for easy use with higher torque and faster speed
- The hexagonal shaft allows tightening with an open ended spanner for extra torque if needed
- Designed and manufactured to DIN5264.

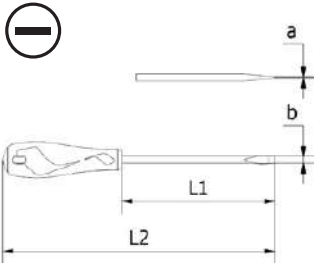

ITEM ID:	a mm	b mm			L1 mm	L2 mm		
MDT932N	1.2	6.5	Hex	Flared	100	216	120	L
MDT934N	1.2	8	Hex	Flared	150	275	200	XL
MDT935N	1.6	10	Hex	Flared	200	325	200	XL

## POWER THROUGH SCREWDRIVERS - PH TIP

- Percussion cap and power through blade for striking with a hammer
- Ergonomically designed bi-material handle for easy use with higher torque and faster speed
- The hexagonal shaft allows tightening with an open ended spanner for extra torque if needed
- Designed and manufactured to DIN ISO 8764

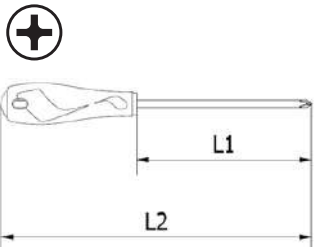

ITEM ID:				L1 mm	L2 mm		
MDT952N	PH2	Hex	Phillips	100	216	120	L
MDT953N	PH3	Hex	Phillips	150	275	200	XL

Shaft Type    Handle Type

Tip Type    Weight



## POWER THROUGH SCREWDRIVER SET

- Chrome vanadium blades for greater strength and material flexibility
- Percussion cap and full length integral blade for use with a hammer to release stubborn screws
- Ergonomically designed bi-material handle for easy use with higher torque and faster speed
- The handle is moulded around the blade to ensure straightness and to allow larger blade wings which give a higher torque capacity

SCREWDRIVERS:				
	mm:	6.5 x 100	8 x 150	10 x 200
	mm:	PH2 x 100	PH3 x 150	

Item ID: TTXMDTN



## POWER THROUGH SCREWDRIVER SET

- Chrome vanadium blades for greater strength and material flexibility
- Percussion cap and full length integral blade for use with a hammer to release stubborn screws
- Ergonomically designed bi-material handle for easy use with higher torque
- The handle is moulded around the blade to give a higher torque capacity
- Tools are held in place using three colour pre-cut EVA foam

SCREWDRIVERS:				
	mm:	6.5 x 100	8 x 150	10 x 200
	mm:	PH2 x 100	PH3 x 150	

Item ID: TEXMDTN







5 Pieces  

**POWER THROUGH SCREWDRIVER SET**

- Chrome vanadium blades for greater strength
- Percussion cap and full length integral blade for use with a hammer
- Ergonomically designed bi-material handle for easy use with higher torque
- The handle is moulded around the blade to ensure straightness
- Supplied with a wall rack for fixing to the wall or a workbench

SCREWDRIVERS:				
	mm:	6.5 x 100	8 x 150	10 x 200
	mm:	PH2 x 100	PH3 x 150	

Item ID: **WRMDT05N**

**NEW NUT DRIVERS**

- Single hexagon 6 point socket
- Screwdriver type handle for use with hexagon nuts and bolts
- Chrome vanadium steel alloy for greater strength
- Ergonomically designed bi-material handle for higher torque
- Hole in the handle for hanging or for use as a T handle for extra torque
- The handle is moulded around the blade to give a higher torque capacity
- Designed and manufactured to DIN3125



ITEM ID:	Size mm	Shaft Length	Overall Length		g
MDN505	5	125	234		91
MDN5055	5.5	125	234		93
MDN506	6	125	234		93
MDN507	7	125	234		98
MDN508	8	125	234		102
MDN510	10	125	242		130
MDN511	11	125	242		153
MDN512	12	125	242		153
MDN513	13	125	242		160

**T HANDLE NUT DRIVERS**

- Single hexagon 6 point socket
- T handle type driver for use with hexagon nuts and bolts
- Chrome vanadium steel alloy for greater strength
- Ergonomically designed bi-material handle for higher torque
- Hole in the handle for hanging or for use with a fall protection wire
- Designed and manufactured to DIN3125



ITEM ID:	Size mm	Overall Length
MDNT405	5	288
MDNT4055	5.5	288
MDNT406	6	288
MDNT407	7	288
MDNT408	8	288
MDNT409	9	288
MDNT410	10	288
MDNT411	11	288
MDNT412	12	288
MDNT413	13	288
MDNT414	14	288



**NEW**



Get organised
Tray Size
TTX

**NUT DRIVER SET**

9 Pieces **mm**

- 6 point socket ends for a perfect fit
- Chrome vanadium for greater strength and material flexibility
- Ergonomically designed bi-material handle for easy use with higher torque
- Hanging hole in the handle for use as a T handle or for use with a fall protection wire
- The handle is moulded around the blade which give a higher torque capacity

Nut Drivers:	
	5, 5.5, 6, 7, 8, 10, 11, 12, 13 mm

Item ID: **TTXND**



## MAGNETIC CHARGER

- Magnetic screwdriver charger and discharger
- Use to magnetise or demagnetise screwdrivers
- Supplied on a handy key ring

Item ID: MR500



## SCREWDRIVER SET



- TT-MV PLUS steel alloy for greater strength and material flexibility
- Ergonomically designed bi-material handle for easy use with higher torque
- Hanging hole in the handle for use as a T handle or with a fall protection wire
- The handle is moulded around the blade to give a higher torque capacity

SCREWDRIVERS:			
⊖ mm:	3 x 75	5.5 x 75	6.5 x 100
⊕ mm:	PH0 x 75	PH1 x 75	PH2 x 100
⊕ mm:	PZ2 x 100		

Item ID: TT917N



## SCREWDRIVER SET



- TT-MV PLUS steel alloy for greater strength and material flexibility
- Ergonomically designed bi-material handle for easy use with higher torque
- Hanging hole in the handle for use as a T handle or with a fall protection wire
- The handle is moulded around the blade to give a higher torque capacity

SCREWDRIVERS:			
⊕ mm:	TX6 x 75	TX9 x 75	
⊕ mm:	TPX10 x 100	TPX15 x 100	TPX20 x 100
	TPX25 x 100	TPX30 x 100	

Item ID: TT917TXN



## SCREWDRIVER SET



- TT-MV PLUS steel alloy for greater strength and material flexibility
- Ergonomically designed bi-material handle for easy use with higher torque
- Hanging hole in the handle for use as a T handle or with a fall protection wire
- The handle is moulded around the blade to give a higher torque capacity

SCREWDRIVERS:				
⊖ mm:	3 x 75	3.5 x 100	5.5 x 75	5.5 x 125
	6.5 x 38	6.5 x 100		
⊕ mm:	PH0 x 75	PH1 x 75	PH2 x 38	PH2 x 100
⊕ mm:	PZ0 x 75	PZ1 x 75	PZ2 x 38	PZ2 x 100

Item ID: TTD914N



## SCREWDRIVER SET



- TT-MV PLUS steel alloy for greater strength and material flexibility
- Ergonomically designed bi-material handle for easy use with higher torque
- Hanging hole in the handle for use as a T handle or with a fall protection wire
- The handle is moulded around the blade to give a higher torque capacity

SCREWDRIVERS:				
⊕ mm:	TX6 x 75	TX7 x 75	TX8 x 75	TX9 x 75
	TX10 x 100	TX15 x 100	TX20 x 100	TX25 x 100
	TX27 x 100	TX30 x 100	TX40 x 100	TX45 x 125

Item ID: TTD912TXN



**SCREWDRIVER SET**



- TT-MV PLUS steel alloy for greater strength and material flexibility
- Ergonomically designed bi-material handle for easy use with higher torque
- Hanging hole in the handle for use as a T handle or with a fall protection wire
- The handle is moulded around the blade to give a higher torque capacity

SCREWDRIVERS:				
⊖ mm:	3 x 100	5.5 x 150	6.5 x 38	6.5 x 100
	8 x 150	10 x 200		
⊕ mm:	PH2 x 38	PH3 x 150		

Item ID: **TTX918N**



**SCREWDRIVER SET**



- TT-MV PLUS steel alloy for greater strength and material flexibility
- Ergonomically designed bi-material handle for easy use with higher torque
- Hanging hole in the handle for use as a T handle or with a fall protection wire
- The handle is moulded around the blade to give a higher torque capacity
- Tools are held in place using three colour pre-cut EVA foam

SCREWDRIVERS:			
⊛ mm:	TX6 x 75	TX8 x 75	TX9 x 75
	TX10 x 100	TX15 x 100	TX20 x 100
	TX25 x 100	TX27 x 100	TX30 x 100

Item ID: **TED909TXN**



**SCREWDRIVER SET**



- TT-MV PLUS steel alloy for greater strength and material flexibility
- Ergonomically designed bi-material handle for easy use with higher torque
- Hanging hole in the handle for use as a T handle or with a fall protection wire
- The handle is moulded around the blade to give a higher torque capacity
- Tools are held in place using three colour pre-cut EVA foam

SCREWDRIVERS:				
⊖ mm:	3.5 x 100	5.5 x 75	5.5 x 125	6.5 x 38
	6.5 x 100			
⊕ mm:	PH0 x 75	PH1 x 75	PH2 x 38	PH2 x 100
⊕ mm:	PZ1 x 75	PZ2 x 100		

Item ID: **TED911N**



**SCREWDRIVER SET**



- TT-MV PLUS steel alloy for greater strength and material flexibility
- Ergonomically designed bi-material handle for easy use with higher torque
- Hanging hole in the handle for use as a T handle or with a fall protection wire
- The handle is moulded around the blade to give a higher torque capacity
- Tools are held in place using three colour pre-cut EVA foam

SCREWDRIVERS:				
⊖ mm:	5.5 x 150	6.5 x 150	8 x 150	10 x 200
	PH3 x 150			

Item ID: **TEX915N**



## SCREWDRIVER RACK



- TT-MV PLUS steel alloy for greater strength and material flexibility
- Ergonomically designed bi-material handle for easy use with higher torque
- The handle is moulded around the blade to ensure straightness
- Supplied with a wall rack for fixing to the wall or a workbench

SCREWDRIVERS:			
⊖ mm:	3 x 100	5.5 x 75	5.5 x 150
	6.5 x 150	8 x 150	
⊕ mm:	PH0 x 75	PH1 x 75	PH2 x 100
⊕ mm:	PZ1 x 75	PZ2 x 100	

Item ID: WRMD10N



## SCREWDRIVER SET



- TT-MV PLUS steel alloy for greater strength and material flexibility
- Ergonomically designed bi-material handle for easy use with higher torque and faster speed
- Hole in the handle for hanging or for use as a T handle for extra torque or with a fall protection wire if needed
- The handle is moulded around the blade to ensure straightness and to allow larger blade wings which give a higher torque capacity
- Includes Ratcheting bits driver with 1/4" hex drive 2.5mm length bits
- Bits range includes Flat, PH, PZ, TX, TPX, ROB and hexagon sizes
- Supplied in a handy carrying case

1/4" hex x 1/4" square drive adaptor				
SCREWDRIVERS:				
⊖ mm:	3.0 x 75	3.0 x 100	4.0 x 100	5.5 x 75
	5.5 x 150	6.0 x 38	6.5 x 100	6.5 x 150
	8.0 x 150	10.0 x 200		
⊕ mm:	PH1 x 75	PH2 x 38	PH2 x 100	PH3 x 150
⊕ mm:	PZ0 x 75	PZ1 x 75	PZ2 x 38	PZ2 x 100
	PZ3 x 150			
RATCHETING BITS DRIVER				
25 mm BITS:				
⊖ mm:	1.2 x 5	1.4 x 7		
⊕	PH1	PH2		
⊕	PZ0	PZ1	PZ2	
⊕	TX6	TX7	TX8	TX9
	TX10	TX15 (x2)	TX20 (x2)	TX25 (x2)
	TX30	TX40		
⊕	TPX20	TPX25	TPX30	
⊕	ROB1	ROB2	ROB3	
⊕ mm:	2	3	4	5
	6	8		





Item ID: MD9053N



**SCREWDRIVER SET**



- Includes 1,000 volt insulated 3.0mm flat blade screwdriver
- TT-MV PLUS steel alloy for greater strength and material flexibility
- Ergonomically designed bi-material handle for easy use with higher torque and faster speed
- Hole in the handle for hanging or for use as a T handle for extra torque or with a fall protection wire if needed
- The handle is moulded around the blade to ensure straightness and to allow larger blade wings which give a higher torque capacity
- Supplied in a handy carrying case

SCREWDRIVERS:				
 mm:	3.0 x 100	5.5 x 75	5.5 x 150	6.5 x 150
  mm:	3.0 x 100			
 mm:	PH0 x 75	PH1 x 75	PH2 x 100	
 mm:	PZ1 x 75	PZ2 x 100		



Item ID: **MD910N**



**SCREWDRIVER SET**



- TT-MV PLUS steel alloy for greater strength and material flexibility
- Ergonomically designed bi-material handle for easy use with higher torque and faster speed
- Hole in the handle for hanging or for use as a T handle for extra torque or with a fall protection wire if needed
- The handle is moulded around the blade to ensure straightness and to allow larger blade wings which give a higher torque capacity
- Supplied in a handy carrying case

SCREWDRIVERS:				
 mm:	3 x 100	5.5 x 75	5.5 x 150	6.5 x 38
	6.5 x 150			
 mm:	PH0 x 75	PH1 x 75	PH2 x 38	PH2 x 100
 mm:	PZ1 x 75	PZ2 x 100		

Item ID: **MD911N**

**NEW**



**SCREWDRIVER SET**



- TT-MV PLUS steel alloy for greater strength and material flexibility
- Ergonomically designed bi-material handle for easy use with higher torque and faster speed
- Hole in the handle for hanging or for use as a T handle for extra torque or with a fall protection wire if needed
- The handle is moulded around the blade to ensure straightness and to allow larger blade wings which give a higher torque capacity
- Supplied in a full colour display box with PS tray

SCREWDRIVERS:		
 mm:	2.5 x 50	3 x 75
	4 x 100	5.5 x 150
	6.5 x 150	

Item ID: **MD906N5**





## SCREWDRIVER SET



- TT-MV PLUS steel alloy for greater strength and material flexibility
- Ergonomically designed bi-material handle for easy use with higher torque and faster speed
- Hole in the handle for hanging or for use as a T handle for extra torque or with a fall protection wire if needed
- The handle is moulded around the blade to ensure straightness and to allow larger blade wings which give a higher torque capacity
- Supplied in a full colour display box with PS tray

SCREWDRIVERS:			
	mm:	3 x 75	5.5 x 100
	mm:	PH1 x 75	PH2 x 100
	mm:	PZ1 x 75	PZ2 x 100

Item ID: MD906N



## SCREWDRIVER SET



- TT-MV PLUS steel alloy for greater strength and material flexibility
- Ergonomically designed bi-material handle for easy use with higher torque and faster speed
- Hole in the handle for hanging or for use as a T handle for extra torque or with a fall protection wire if needed
- The handle is moulded around the blade to ensure straightness and to allow larger blade wings which give a higher torque capacity
- Supplied in a full colour display box with PS tray

SCREWDRIVERS:					
	mm:	3 x 75	4 x 100	5.5 x 75	6.5 x 100
	mm:	PZ1 x 75	PZ2 x 100		

Item ID: MD906N4



## SCREWDRIVER SET



- TT-MV PLUS steel alloy for greater strength and material flexibility
- Ergonomically designed bi-material handle for easy use with higher torque and faster speed
- Hole in the handle for hanging or for use as a T handle for extra torque or with a fall protection wire if needed
- The handle is moulded around the blade to ensure straightness and to allow larger blade wings which give a higher torque capacity
- Supplied in a full colour display box with PS tray

SCREWDRIVERS:					
	mm:	3 x 75	4 x 100	5.5 x 75	6.5 x 100
	mm:	PH1 x 75	PH2 x 100		

Item ID: MD906N3



## SCREWDRIVER SET



- TT-MV PLUS steel alloy for greater strength and material flexibility
- Ergonomically designed bi-material handle for easy use with higher torque and faster speed
- Hole in the handle for hanging or for use as a T handle for extra torque or with a fall protection wire if needed
- The handle is moulded around the blade to ensure straightness and to allow larger blade wings which give a higher torque capacity
- Supplied in a full colour display box with PS tray

SCREWDRIVERS:					
	mm:	PZ1 x 75	PZ2 x 100		
	mm:	TX10 x 100	TX15 x 100	TX20 x 100	TX25 x 100

Item ID: MD906N2



**SCREWDRIVER SET**



- TT-MV PLUS steel alloy for greater strength and material flexibility
- Ergonomically designed bi-material handle for easy use with higher torque and faster speed
- Hole in the handle for hanging or for use as a T handle for extra torque or with a fall protection wire if needed
- The handle is moulded around the blade to ensure straightness and to allow larger blade wings which give a higher torque capacity
- Supplied in a full colour display box with PS tray

SCREWDRIVERS:				
	mm:	TX10 x 100	TX15 x 100	TX20 x 100
		TX25 x 100	TX30 x 100	TX40 x 100



Item ID: **MD906N1**



**SCREWDRIVER SET**



- TT-MV PLUS steel alloy for greater strength and material flexibility
- Ergonomically designed bi-material handle for easy use with higher torque and faster speed
- Hole in the handle for hanging or for use as a T handle for extra torque or with a fall protection wire if needed
- The handle is moulded around the blade to ensure straightness and to allow larger blade wings which give a higher torque capacity
- Supplied in a full colour display box with PS tray

SCREWDRIVERS:					
	mm:	2.5 x 75	3.5 x 100	4 x 150	5.5 x 150
		6.5 x 150	10 x 200		
	mm:	PH0 x 75	PH1 x 75	PH2 x 100	PH2 x 200
	mm:	PZ1 x 75	PZ2 x 100		



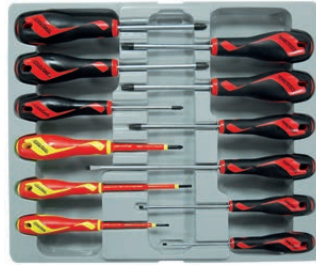





Item ID: **MD912N**



**SCREWDRIVER SET**



- TT-MV PLUS steel alloy for greater strength and material flexibility
- Ergonomically designed bi-material handle for easy use with higher torque and faster speed
- Hole in the handle for hanging or for use as a T handle for extra torque or with a fall protection wire if needed
- The handle is moulded around the blade to ensure straightness and to allow larger blade wings which give a higher torque capacity
- Supplied in a full colour display box with PS tray

SCREWDRIVERS:				
	mm:	2.5 x 75	3.5 x 100	5.5 x 150
		mm:	2.5 x 75	3.0 x 100
	mm:	PH1 x 75	PH1 x 80	
		mm:	PH2 x 100	
	mm:	PZ2 x 100		
	mm:	TX20 x 100	TX25 x 100	TX30 x 100

Item ID: **MD912N1**



# BITS & DRIVERS

QUALITY YOU CAN **TRUST**

All Teng Tools bits with a hexagonal drive are designed and manufactured in accordance with the latest industrial standards. Screwdriver bits and socket bits are classified as consumables and thus are only guaranteed to meet dimensional standards.

Bit sets supplied in handy pocket sized storage with bits that are easy to access

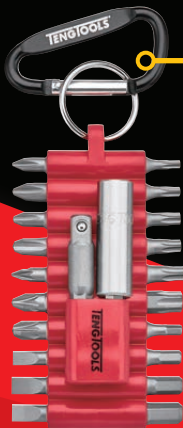

Bit sets with belt clip available in standard and impact

Full range of bit adapters, screw holders and accessories are available



Bits drivers for every application that allow you to access the hardest to reach fasteners



An extensive range of bit drivers are available in the range including ratcheting drivers, stubby drivers and folding handle drivers for greater power transfer. A selection of drivers offer the option of storing bits in the handle so you do not have to waste time searching for bits when you need them.





## DOUBLE ENDED FLAT (SLOTTED) BIT

- Designed for use with slotted type screws and fastenings
- Ideal for use with rechargeable and electric screwdrivers
- Designed and manufactured to DIN ISO 1173 & DIN ISO 2380



ITEM ID	Size 1 mm	Size 2 mm	Drive	Pack Qty	Length mm
FTF32406005	0.8 x 4	1.2 x 6	1/4" Hex	5	32

## FLAT (SLOTTED) BITS

- For use with 1/4" hex drive bit holders and accessories
- Designed for use with slotted type screws and fastenings
- Designed and manufactured to DIN ISO 1173 & DIN ISO 2351-1



ITEM ID	Size mm	Drive	Pack Qty	Length mm
FL2506A03	0.6 x 3.5	1/4" Hex	3	25
FL2506B03	0.6 x 4.5	1/4" Hex	3	25
FL2508A03	0.8 x 4	1/4" Hex	3	25
FL2508B03	0.8 x 5.5	1/4" Hex	3	25
FL2510A03	1.0 x 5.5	1/4" Hex	3	25
FL2512A03	1.2 x 6.5	1/4" Hex	3	25
FL2516A03	1.6 x 8	1/4" Hex	3	25

## FLAT (SLOTTED) BITS

- For use with 1/4" hex drive bit holders and accessories
- Designed for use with slotted type screws and fastenings
- Designed and manufactured to DIN ISO 1173 & DIN ISO 2351-1



ITEM ID	Size mm	Drive	Pack Qty	Length mm
FL5006A03	0.6 x 3.5	1/4" Hex	3	50
FL5008A03	0.8 x 4	1/4" Hex	3	50
FL5008B03	0.8 x 5.5	1/4" Hex	3	50
FL5010A03	1.0 x 5.5	1/4" Hex	3	50
FL5012A03	1.2 x 6.5	1/4" Hex	3	50

## FLAT (SLOTTED) BITS

- For use with 1/4" hex drive bit holders and accessories
- Designed for use with slotted type screws and fastenings
- Designed and manufactured to DIN ISO 1173 & DIN ISO 2351-1



ITEM ID	Size mm	Drive	Pack Qty	Length mm
FL7006A02	0.6 x 3.5	1/4" Hex	2	70
FL7008A02	0.8 x 4	1/4" Hex	2	70
FL7008B02	0.8 x 5.5	1/4" Hex	2	70
FL7010A02	1.0 x 5.5	1/4" Hex	2	70

## FLAT (SLOTTED) BITS

- For use with 1/4" hex drive bit holders and accessories
- Designed for use with slotted type screws and fastenings
- Designed and manufactured to DIN ISO 1173 & DIN ISO 2351-1



ITEM ID	Size mm	Drive	Pack Qty	Length mm
FL8905A01	0.5 x 3	1/4" Hex	1	89
FL8908A01	0.8 x 4	1/4" Hex	1	89

## DOUBLE ENDED PH BITS

- Designed for use with Phillips type screws and fastenings
- Ideal for use with rechargeable and electric screwdrivers
- Designed and manufactured to DIN ISO 1173 & DIN ISO 8764-1



ITEM ID	Size 1	Size 2	Drive	Pack Qty	Length mm
PHH32000305	PH0	PH3	1/4" Hex	5	32
PHH32010205	PH1	PH2	1/4" Hex	5	32



**PH BITS**

- For use with 1/4" hex drive bit holders and accessories
- Designed for use with Phillips type screws and fastenings
- Designed and manufactured to DIN ISO 2351-2 & DIN ISO 1173



ITEM ID	Size	Drive	Pack Qty	Length mm
PH2500103	PH1	1/4" Hex	3	25
PH2500110	PH1	1/4" Hex	10	25
PH2500203	PH2	1/4" Hex	3	25
PH2500210	PH2	1/4" Hex	10	25
PH2500303	PH3	1/4" Hex	3	25
PH2500310	PH3	1/4" Hex	10	25

**PH BITS**

- For use with 1/4" hex drive bit holders and accessories
- Designed for use with Phillips type screws and fastenings
- Designed and manufactured to DIN ISO 2351-2 & DIN ISO 1173



ITEM ID	Size	Drive	Pack Qty	Length mm
PH5000103	PH1	1/4" Hex	3	50
PH5000203	PH2	1/4" Hex	3	50
PH5000303	PH3	1/4" Hex	3	50

**PH BITS**

- For use with 1/4" hex drive bit holders and accessories
- Designed for use with Phillips type screws and fastenings
- Designed and manufactured to DIN ISO 2351-2 & DIN ISO 1173



ITEM ID	Size	Drive	Pack Qty	Length mm
PH7000102	PH1	1/4" Hex	2	70
PH7000202	PH2	1/4" Hex	2	70

**PH BITS**

- For use with 1/4" hex drive bit holders and accessories
- Designed for use with Phillips type screws and fastenings
- Designed and manufactured to DIN ISO 2351-2 & DIN ISO 1173



ITEM ID	Size	Drive	Pack Qty	Length mm
PH8900101	PH1	1/4" Hex	1	89
PH8900201	PH2	1/4" Hex	1	89

**PH IMPACT SCREWDRIVER BIT**

- Designed for higher torsion
- For use with 1/4" hex drive bit holders and accessories
- Designed for use with Phillips type screws and fastenings



ITEM ID	Size	Drive	Pack Qty	Length mm
PHP3000101	PH1	1/4" Hex	1	30
PHP3000105	PH1	1/4" Hex	5	30
PHP3000201	PH2	1/4" Hex	1	30
PHP3000205	PH2	1/4" Hex	5	30
PHP3000301	PH3	1/4" Hex	1	30
PHP3000305	PH3	1/4" Hex	5	30
PHP5000101	PH1	1/4" Hex	1	50
PHP5000201	PH2	1/4" Hex	1	50
PHP5000301	PH3	1/4" Hex	1	50
PHP8900201	PH2	1/4" Hex	1	89

**PH2G BITS**

- GR type with reduced neck designed for use with dry wall screws
- For use with 1/4" hex drive bit holders and accessories
- Designed for use with Phillips type screws and fastenings
- Designed and manufactured to DIN ISO 2351-2 & DIN ISO 1173



ITEM ID	Size	Drive	Pack Qty	Length mm
GR25002010	PH2G	1/4" Hex	10	25
GR25002100	PH2G	1/4" Hex	100	25



**PH2G IMPACT SCREWDRIVER BIT**

- Designed for higher torsion
- PH2G type with reduced neck designed for use with dry wall screws
- For use with 1/4" hex drive bit holders and accessories



ITEM ID	Size	Drive	Pack Qty	Length mm
GRP3000201	PH2G	1/4" Hex	1	30
GRP3000205	PH2G	1/4" Hex	5	30
GRP5000201	PH2G	1/4" Hex	1	50



**PZ BITS**

- For use with 1/4" hex drive bit holders and accessories
- Designed for use with Pozidriv type screws and fastenings
- Designed and manufactured to DIN ISO 2351-2 & DIN ISO 1173



ITEM ID	Size	Drive	Pack Qty	Length mm
PZ5000103	PZ1	1/4" Hex	3	50
PZ5000203	PZ2	1/4" Hex	3	50
PZ5000303	PZ3	1/4" Hex	3	50



**DOUBLE ENDED PZ BITS**

- Designed for use with Pozidriv type screws and fastenings
- Ideal for use with rechargeable and electric screwdrivers
- Designed and manufactured to DIN3126



ITEM ID	Size 1 mm	Size 2 mm	Drive	Pack Qty	Length mm
PZZ32000305	PZ0	PZ3	1/4" Hex	5	32
PZZ32010205	PZ1	PZ2	1/4" Hex	5	32



**PZ BITS**

- For use with 1/4" hex drive bit holders and accessories
- Designed for use with Pozidriv type screws and fastenings
- Designed and manufactured to DIN ISO 2351-2 & DIN ISO 1173



ITEM ID	Size	Drive	Pack Qty	Length mm
PZ7000102	PZ1	1/4" Hex	2	70
PZ7000202	PZ2	1/4" Hex	2	70



**PZ BITS**

- For use with 1/4" hex drive bit holders and accessories
- Designed for use with Pozidriv type screws and fastenings
- Designed and manufactured to DIN ISO 2351-2 & DIN ISO 1173



ITEM ID	Size	Drive	Pack Qty	Length mm
PZ2500103	PZ1	1/4" Hex	3	25
PZ2500110	PZ1	1/4" Hex	10	25
PZ2500203	PZ2	1/4" Hex	3	25
PZ2500210	PZ2	1/4" Hex	10	25
PZ2500303	PZ3	1/4" Hex	3	25
PZ2500310	PZ3	1/4" Hex	10	25



**PZ BITS**

- For use with 1/4" hex drive bit holders and accessories
- Designed for use with Pozidriv type screws and fastenings
- Designed and manufactured to DIN ISO 2351-2 & DIN ISO 1173



ITEM ID	Size	Drive	Pack Qty	Length mm
PZ8900101	PZ1	1/4" Hex	1	89
PZ8900201	PZ2	1/4" Hex	1	89



**PZ IMPACT SCREWDRIVER BIT**

- Designed for higher torsion
- For use with 1/4" hex drive bit holders and accessories
- Designed for use with Pozidriv type screws and fastenings



ITEM ID	Size	Drive	Pack Qty	Length mm
PZP3000101	PZ1	1/4" Hex	1	30
PZP3000105	PZ1	1/4" Hex	5	30
PZP3000201	PZ2	1/4" Hex	1	30
PZP3000205	PZ2	1/4" Hex	5	30
PZP3000301	PZ3	1/4" Hex	1	30
PZP3000305	PZ3	1/4" Hex	5	30
PZP5000101	PZ1	1/4" Hex	1	50
PZP5000201	PZ2	1/4" Hex	1	50
PZP5000301	PZ3	1/4" Hex	1	50
PZP8900201	PZ2	1/4" Hex	1	89

**TX BITS**

- For use with 1/4" hex drive bit holders and accessories
- Designed for use with fastenings with an internal TX type hole
- Designed and manufactured to DIN ISO 1173



ITEM ID	Size	Drive	Pack Qty	Length mm
TX2500603	TX6	1/4" Hex	3	25
TX2500703	TX7	1/4" Hex	3	25
TX2500803	TX8	1/4" Hex	3	25
TX2500903	TX9	1/4" Hex	3	25
TX2501003	TX10	1/4" Hex	3	25
TX2501503	TX15	1/4" Hex	3	25
TX2502003	TX20	1/4" Hex	3	25
TX2502503	TX25	1/4" Hex	3	25
TX2502703	TX27	1/4" Hex	3	25
TX2503003	TX30	1/4" Hex	3	25
TX2504003	TX40	1/4" Hex	3	25

**DOUBLE ENDED TX BITS**

- For use with fastenings with an internal TX type hole
- Ideal for use with rechargeable and electric screwdrivers
- Designed and manufactured to DIN ISO 1173



ITEM ID	Size 1	Size 2	Drive	Pack Qty	Length mm
TXX32101505	TX10	TX15	1/4" Hex	5	32
TXX32202505	TX20	TX25	1/4" Hex	5	32

**TX BITS**

- For use with 1/4" hex drive bit holders and accessories
- Designed for use with fastenings with an internal TX type hole
- Designed and manufactured to DIN ISO 1173



ITEM ID	Size	Drive	Pack Qty	Length mm
TXS000803	TX8	1/4" Hex	3	50
TXS001003	TX10	1/4" Hex	3	50
TXS001503	TX15	1/4" Hex	3	50
TXS002003	TX20	1/4" Hex	3	50
TXS002503	TX25	1/4" Hex	3	50
TXS002703	TX27	1/4" Hex	3	50
TXS003003	TX30	1/4" Hex	3	50



**TX BITS**

- For use with 1/4" hex drive bit holders and accessories
- Designed for use with fastenings with an internal TX type hole
- Designed and manufactured to DIN ISO 1173



ITEM ID	Size	Drive	Pack Qty	Length mm
TX7001002	TX10	1/4" Hex	2	70
TX7001502	TX15	1/4" Hex	2	70
TX7002002	TX20	1/4" Hex	2	70
TX7002502	TX25	1/4" Hex	2	70



**TX IMPACT SCREWDRIVER BIT**

- Designed for higher torsion
- For use with 1/4" hex drive bit holders and accessories
- Designed for use with fastenings with an internal TX hole



ITEM ID	Size mm	Drive	Pack Qty	Length mm
TXP3001001	TX10	1/4" Hex	1	30
TXP3001005	TX10	1/4" Hex	5	30
TXP3001501	TX15	1/4" Hex	1	30
TXP3001505	TX15	1/4" Hex	5	30
TXP3002001	TX20	1/4" Hex	1	30
TXP3002005	TX20	1/4" Hex	5	30
TXP3002501	TX25	1/4" Hex	1	30
TXP3002505	TX25	1/4" Hex	5	30
TXP3002701	TX27	1/4" Hex	1	30
TXP3002705	TX27	1/4" Hex	5	30
TXP3003001	TX30	1/4" Hex	1	30
TXP3003005	TX30	1/4" Hex	5	30
TXP3004001	TX40	1/4" Hex	1	30
TXP3004005	TX40	1/4" Hex	5	30
TXP5001001	TX10	1/4" Hex	1	50
TXP5001501	TX15	1/4" Hex	1	50
TXP5002001	TX20	1/4" Hex	1	50
TXP5002501	TX25	1/4" Hex	1	50
TXP5002701	TX27	1/4" Hex	1	50
TXP5003001	TX30	1/4" Hex	1	50
TXP5004001	TX40	1/4" Hex	1	50
TXP8902001	TX20	1/4" Hex	1	89
TXP8902501	TX25	1/4" Hex	1	89
TXP8903001	TX30	1/4" Hex	1	89



**TX BITS**

- For use with 1/4" hex drive bit holders and accessories
- Designed for use with fastenings with an internal TX type hole
- Designed and manufactured to DIN ISO 1173



ITEM ID	Size mm	Drive	Pack Qty	Length mm
TX8901001	TX10	1/4" Hex	1	89
TX8902001	TX20	1/4" Hex	1	89
TX8902501	TX25	1/4" Hex	1	89
TX8903001	TX30	1/4" Hex	1	89



**TX BITS**

- 10/12 mm hexagon drive for use with appropriate bit holders
- Designed for use with fastenings with a TX hole
- Designed and manufactured to DIN ISO 1173



ITEM ID	Size mm	Drive	Pack Qty	Length mm
220720	TX20	10mm Hex	1	40
220725	TX25	10mm Hex	1	40
220727	TX27	10mm Hex	1	40
220730	TX30	10mm Hex	1	40
220740	TX40	10mm Hex	1	40
220745	TX45	10mm Hex	1	40
220750	TX50	10mm Hex	1	40
220755	TX55	10mm Hex	1	40
220760	TX60	12mm Hex	1	40
220770	TX70	12mm Hex	1	40



**TPX BITS**

- For use with 1/4" hex drive bit holders and accessories
- Designed for use with fastenings with a tamper proof TPX type hole
- Use with internal TPX heads
- Designed and manufactured to DIN ISO 1173



ITEM ID	Size	Drive	Pack Qty	Length mm
TPX2501003	TPX10	1/4" Hex	3	25
TPX2501503	TPX15	1/4" Hex	3	25
TPX2502003	TPX20	1/4" Hex	3	25
TPX2502503	TPX25	1/4" Hex	3	25
TPX2502703	TPX27	1/4" Hex	3	25
TPX2503003	TPX30	1/4" Hex	3	25
TPX2504003	TPX40	1/4" Hex	3	25



**TX BITS**

- 10/12 mm hexagon drive for use with appropriate bit holders
- Designed for use with fastenings with a TX hole
- Designed and manufactured to DIN ISO 1173



ITEM ID	Size mm	Drive	Pack Qty	Length mm
220820	TX20	10mm Hex	1	75
220825	TX25	10mm Hex	1	75
220827	TX27	10mm Hex	1	75
220830	TX30	10mm Hex	1	75
220840	TX40	10mm Hex	1	75
220845	TX45	10mm Hex	1	75
220850	TX50	10mm Hex	1	75
220855	TX55	10mm Hex	1	75
220860	TX60	12mm Hex	1	75
220870	TX70	12mm Hex	1	75



**HEX BITS**

- For use with 1/4" hex drive bit holders and accessories
- Designed for use with fastenings with a hexagon hole
- Use with in-hex screws or grub screws
- Designed and manufactured to DIN ISO 2351-3 & DIN ISO 1173



ITEM ID	Size mm	Drive	Pack Qty	Length mm
HEX2500203	2	1/4" Hex	3	25
HEX2500303	3	1/4" Hex	3	25
HEX2500403	4	1/4" Hex	3	25
HEX2500503	5	1/4" Hex	3	25
HEX2500603	6	1/4" Hex	3	25
HEX2500803	8	1/4" Hex	3	25







**HEX BITS**

- For use with 1/4" hex drive bit holders and accessories
- Designed for use with fastenings with a hexagon hole
- Use with in-hex screws or grub screws
- Designed and manufactured to DIN ISO 2351-3 & DIN ISO 1173



ITEM ID	Size mm	Drive	Pack Qty	Length mm
HEX5000403	4	1/4" Hex	3	50
HEX5000503	5	1/4" Hex	3	50
HEX5000603	6	1/4" Hex	3	50
HEX5000803	8	1/4" Hex	3	50



**HEX IMPACT SCREWDRIVER BIT**

- Designed for higher torsion
- For use with 1/4" hex drive bit holders and accessories
- Designed for use with fastenings with a hexagon hole
- Use with in-hex screws or grub screws



ITEM ID	Size mm	Drive	Pack Qty	Length mm
HEXP3000301	3mm	1/4" Hex	1	30
HEXP3000305	3mm	1/4" Hex	5	30
HEXP3000401	4mm	1/4" Hex	1	30
HEXP3000405	4mm	1/4" Hex	5	30
HEXP3000501	5mm	1/4" Hex	1	30
HEXP3000505	5mm	1/4" Hex	5	30
HEXP3000601	6mm	1/4" Hex	1	30
HEXP3000605	6mm	1/4" Hex	5	30
HEXP5000301	3mm	1/4" Hex	1	50
HEXP5000401	4mm	1/4" Hex	1	50
HEXP5000501	5mm	1/4" Hex	1	50
HEXP5000601	6mm	1/4" Hex	1	50



**HEX BITS**

- For use with 1/4" hex drive bit holders and accessories
- Designed for use with fastenings with a hexagon hole
- Use with in-hex screws or grub screws
- Designed and manufactured to DIN ISO 2351-3 & DIN ISO 1173



ITEM ID	Size mm	Drive	Pack Qty	Length mm
HEX8900401	4	1/4" Hex	1	89



**HEX BITS**

- 10mm/12mm hexagon drive for use with appropriate bit holders
- Designed for use with fastenings with a hexagon hole
- Designed and manufactured to DIN ISO 2351-3 & DIN ISO 1173



ITEM ID	Size mm	Drive	Pack Qty	Length mm
210705	5	10mm Hex	1	40
210706	6	10mm Hex	1	40
210707	7	10mm Hex	1	40
210708	8	10mm Hex	1	40
210709	9	10mm Hex	1	40
210710	10	10mm Hex	1	40
210712	12	12mm Hex	1	40
210714	14	12mm Hex	1	40
210717	17	12mm Hex	1	40
210719	19	12mm Hex	1	40



**HEX BITS**

- 10mm/12mm hexagon drive for use with appropriate bit holders
- Designed for use with fastenings with a hexagon hole
- Designed and manufactured to DIN ISO 2351-3 & DIN ISO 1173



ITEM ID	Size mm	Drive	Pack Qty	Length mm
210805	5	10mm Hex	1	75
210806	6	10mm Hex	1	75
210807	7	10mm Hex	1	75
210808	8	10mm Hex	1	75
210809	9	10mm Hex	1	75
210810	10	10mm Hex	1	75
210812	12	12mm Hex	1	75
210814	14	12mm Hex	1	75
210817	17	12mm Hex	1	75
210819	19	12mm Hex	1	75



**ROB IMPACT SCREWDRIVER BIT**

- Designed for higher torsion
- For use with 1/4" hex drive bit holders and accessories
- Designed for use with ROB recessed heads on screws and fastenings with a square hole



ITEM ID	Size mm	Drive	Pack Qty	Length mm
ROBP3000101	ROB1	1/4" Hex	1	30
ROBP3000105	ROB1	1/4" Hex	5	30
ROBP3000201	ROB2	1/4" Hex	1	30
ROBP3000205	ROB2	1/4" Hex	5	30
ROBP5000101	ROB1	1/4" Hex	1	50
ROBP5000201	ROB2	1/4" Hex	1	50
ROBP5000301	ROB3	1/4" Hex	1	50
ROBP8900101	ROB1	1/4" Hex	1	89
ROBP8900201	ROB2	1/4" Hex	1	89
ROBP8900301	ROB3	1/4" Hex	1	89



**ROB BITS**

- For use with 1/4" hex drive bit holders and accessories
- Designed for screws and fastenings with a square hole
- Designed and manufactured to DIN ISO 1173



ITEM ID	Size	Drive	Pack Qty	Length mm
ROB2500103	ROB1	1/4" Hex	3	25
ROB2500203	ROB2	1/4" Hex	3	25
ROB2500303	ROB3	1/4" Hex	3	25



**NUT SETTERS**

- For use with electric and rechargeable screwdrivers
- Suitable for use on ferrous fastenings



ITEM ID	Size	Drive	Type	Length mm
NS45108M	1/4"	1/4" Hex	Magnetic	45
NS45506M	6mm	1/4" Hex	Magnetic	45
NS45507M	7mm	1/4" Hex	Magnetic	45
NS45508M	8mm	1/4" Hex	Magnetic	45
NS45508R	8mm	1/4" Hex	Ring	45





## IMPACT NUT SETTERS

- 1/4" hexagon drive nut setter
- Designed for higher torsion enabling use with power tools such as electric and rechargeable screwdrivers
- The 6 point 1/4" AF socket includes a magnet for holding the fastening
- Suitable for use on ferrous fastenings



ITEM ID	Size	Drive	Type	Length mm
NSP65108	1/4"	1/4" Hex	Magnetic	65
NSP65507	7mm	1/4" Hex	Magnetic	65
NSP65508	8mm	1/4" Hex	Magnetic	65
NSP65510	10mm	1/4" Hex	Magnetic	65
NSP65513	13mm	1/4" Hex	Magnetic	65



## BIT HOLDERS

- Bits holders with magnetic or quick chuck fittings

ITEM ID	Drive	Holder	Length mm
ACC50MBH01	1/4" Hex	Magnetic	50
ACC70MBH01	1/4" Hex	Magnetic	70
ACC35CBH01	1/4" Hex	Chuck	35
ACC50CBH01	1/4" Hex	Chuck	50



## IMPACT MAGNETIC BITS HOLDER

- S2 stainless steel for use with 1/4" hex drive impact bits
- Overall length 60mm to reach in to hard to reach places
- Recessed magnet holds the bit as well as fastenings (ferrous materials only)
- Designed for higher torsion



Item ID: **MBH114**



## IMPACT MAGNETIC BITS HOLDER

- S2 stainless steel for use with 1/4" hex drive impact bits
- Overall length 60mm to reach in to hard to reach places
- Quick chuck bit holder for quick and easy changing between bits
- Designed for higher torsion



Item ID: **QC114**



## IMPACT ADAPTOR

- 1/4" hexagon drive to 1/4" square drive impact adaptor
- Overall length 50mm to enable access in to recesses
- Enables the use of 1/4" hexagon drive bit drivers with 1/4" drive impact sockets
- Designed for use with power tools such as electric and rechargeable screwdrivers
- Ball bearing socket retainer on the male end to securely grip the socket

ITEM ID:	Length mm	Depth mm	Height mm	Weight g
IBA14	50	8	8	15

## BITS DRIVER EXTENSION

- Fixed shaft with quick chuck bits holder
- Rotating collar to lock or unlock the grip on the bit
- Ideal for use in hard to reach places



ITEM ID	Drive	Extension	Length	
			mm	AF
TTMD74-1	1/4" Hex	Fixed	100	4"

## BITS DRIVER EXTENSION

- Flexible wound spring shaft with quick chuck bits holder
- Rotating collar to lock or unlock the grip on the bit
- Ideal for use in hard to reach places



ITEM ID	Drive	Extension	Length	
			mm	AF
TTMD74-2	1/4" Hex	Flexible	150	6"

**BITS DRIVER EXTENSION**

- Flexible wound spring shaft with quick chuck bits holder
- Ideal for use in hard to reach places



ITEM ID	Drive	Extension	Length	
			mm	AF
ACC300CBH01	1/4" Hex	Flexible	300	12"

**BIT ADAPTORS FOR SOCKETS**

- Adaptor from a 1/4" hex drive to a square socket drive
- Suitable for use with electric and rechargeable screwdrivers
- For use with standard and impact type sockets
- Satin finish for a better grip when handling sockets
- Ball bearing socket retainer on the male end to securely grip the socket



ITEM ID	Hex Drive	Square Drive	Length mm
ACCSDA1414	1/4" Hex	1/4"	50
ACCSDA1438	1/4" Hex	3/8"	50
ACCSDA1412	1/4" Hex	1/2"	50

**COUPLER ADAPTORS**

- Coupler adaptors for holding various bits
- Chrome vanadium
- Satin finish for a better grip when handling the adaptor
- Retaining spring to hold the bit in place
- Designed and manufactured to DIN3126
- Supplied with a metal socket clip for use with a socket rail



ITEM ID	Drive	Converts to	Weight g
M140060-C	1/4"	1/4" Hex Bits	20
M380060-C	3/8"	1/4" Hex Bits	32
M380061-C	3/8"	10mm Hex Bits	32
M120060-C	1/2"	5/16" Hex Bits	88
M120061-C	1/2"	10mm Hex Bits	56
M120062-C	1/2"	12mm Hex Bits	62
M120063-C	1/2"	1/4" Hex Bits	88

**MINI BITS RATCHET**

- 1/4" hex drive reversible bits ratchet
- Overall length 90mm making it very compact and easy to keep in the pocket
- Flip reverse mechanism for quickly changing between tightening and loosening
- Chrome vanadium satin finish drop forged steel
- For use with 1/4" drive hex bits
- 8mm double hexagon ring spanner on the other end



Item ID: 1400B

**RATCHET HEAD & BITS HOLDER**

- Fine tooth mini ratchet head
- Designed for use together with any 1/4" hex drive bit holder
- 1/4" square drive for use with sockets and accessories
- 1/4" hexagon drive for use with screwdriver bits and accessories
- 72 teeth for use in confined spaces
- Flip reverse for quickly and easily changing between tightening and loosening
- Designed and manufactured to DIN3122D



Item ID: RHA14



**TX BIT SET**

- 3/8" drive bit holder/coupler
- 6 TX bits held in a "bullet holder" to avoid losing the bits

3/8" Drive x 1/4" Hex coupler		
1/4" Hex Bits:		
Length 25mm		TX10, TX15, TX20, TX25, TX30, TX40

Item ID: 1486



### TX BIT SET

- 1/2" drive bit holder/coupler
- 3 TX bits held in a "bullet holder" to avoid losing the bits

1/2" DRIVE 4 Pieces

1/2" Drive x 5/16" Hex coupler	
5/16" Hex Bits:	
Length 25mm	TX45, TX50, TX55

Item ID: 1488



### IPR - TAMPER PROOF BIT SET

- For use with 5-wing fastenings with a tamper proof hole
- 1/4" drive bit holder/coupler
- Bits held in a "bullet holder" to avoid losing the bits

1/4" DRIVE 10 Pieces

1/4" Drive x 1/4" Hex coupler	
1/4" Hex Bits:	
Length 25mm	IPR10, IPR15, IPR20, IPR25, IPR30, IPR40, IPR45, IPR50

Item ID: M1410T5

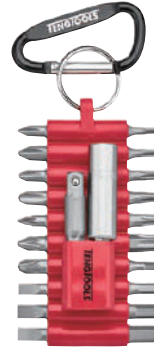

### HOOK ON BITS SET

22 Pieces

- Bit holder with a clip ring for use on a belt or with a safety wire if working at height
- Includes 20 assorted 25mm length bits together with a 60mm magnetic bit holder
- A 1/4" drive adaptor for use with 1/4" drive sockets and accessories

60mm magnetic bit holder, 1/4" Hex x 1/4" M adaptor						
1/4" Hex Bits: Length 25mm	+	PZ1, PZ2, PZ3	+	PH1, PH2, PH3	+	PH2G
	☆	TX10, TX15, TX20, TX25, TX30, TX40				
	●	3, 4, 5, 6	⊖	4.5, 5.5, 6.5 mm		

Item ID: THBS22



### HOOK ON IMPACT BITS SET

22 Pieces

- A handy bit holder with a clip ring for use on a belt or safety wire if working at height
- Includes 20 assorted 30mm length impact bits together with a 60mm magnetic bit holder
- A 1/4" drive adaptor for use with 1/4" drive impact sockets
- Designed for higher torsion enabling use with power tools

60mm Impact magnetic bit holder, 1/4" Hex x 1/4" M adaptor						
1/4" Hex Impact Bits: Length 30mm	+	PZ1, PZ2, PZ3	+	PH1, PH2, PH3	+	PH2G
	☆	TX10, TX15, TX20, TX25, TX30, TX40				
	●	3, 4, 5, 6	■	1, 2, 3		

Item ID: THBSI22





Get organised!















Tray Size				
TJ				

**IMPACT BIT SET**



1/4" DRIVE **53** Pieces

- Screwdriver, hex and TX bits in various lengths
- Metric and AF impact nut setters included
- New design impact bits and adaptors for higher torsion
- Suitable for use with impact power tools

60mm Impact magnetic bit holder, 60mm Impact quick chuck bit holder					
1/4" Drive Impact nut setters - Length 65mm 					
	Size:	1/4"	8	10	13
1/4" Hex Impact Bits: Length 30mm		PH1, PH2 (x2), PH3		PH2G (x2)	1, 2
		PZ1, PZ2 (x2), PZ3		TX10, TX15, TX20 (x2), TX25 (x2), TX27, TX30 (x2), TX40	3, 4 (x2), 5, 6
		TX10, TX15, TX20, TX25, TX27, TX30, TX40		1, 2, 3	
1/4" Hex Impact Bits: Length 50mm		3, 4, 5, 6		PH2G	
		TX20, TX25, TX30		PH2 (X2)	
1/4" Hex Impact Bits: Length 89mm		TX20, TX25, TX30		PH2 (X2)	

Item ID: **TTBS53**



Get organised!











Tray Size				
TEA				

**IMPACT BIT SET**



**50** Pieces 

- Magnetic and quick chuck bit holders included for fast changing
- Designed for higher torsion
- Tools are held in place using three colour pre-cut EVA foam

60mm Impact magnetic bit holder, 60mm Impact quick chuck bit holder					
1/4" Hex Impact Bits: Length 30mm		PH1, PH2 (x2), PH3		PH2G (x2)	1, 2
		PZ1, PZ2 (x2), PZ3		3, 4 (x2), 5, 6	
		TX10, TX15, TX20 (x2), TX25 (x2), TX27, TX30 (x2), TX40			
1/4" Hex Impact Bits: Length 50mm		PH1, PH2, PH3		3, 4, 5, 6	
		PZ1, PZ2, PZ3		1, 2, 3	
		TX10, TX15, TX20, TX25, TX27, TX30, TX40			

Item ID: **TEABS50**

**USE WITH**  
TTTJ04 STORAGE TRAY









STORE 4x TJ SETS IN 1 TRAY

Get organised!

Tray Size				
TJ				

**BIT SET**

- Bit set that fits into the TTTJ04 tool tray allowing you to store 4 TJ sets in a single tray
- 1/4" drive bits ratchet and magnetic bits holder
- A selection of 25mm bits

1/4" bits ratchet, 50mm magnetic bits holder					
1/4" Drive Hex Bits:					
Length 25 mm:		3.5, 5.5, 8		2, 3, 4, 5, 6, 8	
		PH1, PH2, PH3		PZ1, PZ2, PZ3	
		TX10, TX15, TX20, TX25, TX30, TX40		TPX20, TPX25, TPX30	

Item ID: **TJ1429**

**USE WITH**  
TTTJ04 STORAGE TRAY









STORE 4x TJ SETS IN 1 TRAY

Get organised!

Tray Size				
TJ				

**IMPACT BIT SET**

- Bit set that fits into the TTTJ04 tool tray allowing you to store 4 TJ sets in a single tray
- Impact magnetic bits holder and impact quick chuck
- A selection of 30mm impact bits

60mm magnetic impact bit holder, 60mm quick chuck impact bits holder					
1/4" Drive Impact Hex Bits:					
Length 30 mm:		PH1, PH2 (x2), PH3		PZ1, PZ2 (x2), PZ3	
		ROB1, 2		3, 4 (x2), 5, 6	
		TX10, TX15, TX20 (x2), TX25 (x2), TX27, TX30 (x2)			

Item ID: **TJ1430**

**NEW**

## CONSTRUCTION IMPACT BIT SET

- Bit set that fits into the TTTJ04 tool tray allowing you to store 4 TJ sets in a single tray
- 60mm magnetic bits holder
- A selection of 30mm impact bits

60mm magnetic impact bit holder						
1/4" Drive Impact Hex Bits:						
Length 30 mm:		PH2		PH2G		PZ1, PZ2, PZ3
		ROB1, 2				TX10, TX20, TX25, TX30

Item ID: TJ1412

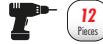
**NEW**

## IMPACT TX BIT SET

- Bit set that fits into the TTTJ04 tool tray allowing you to store 4 TJ sets in a single tray
- 60mm magnetic bits holder
- A selection of 30mm impact TX bits

60mm magnetic impact bit holder		
1/4" Drive Impact Hex Bits:		
Length 30 mm:		TX10, TX15, TX20 (x3), TX25 (x2), TX27, TX30 (x2), TX40

Item ID: TJ1414

**NEW**

## IMPACT BIT SET

- Bit set that fits into the TTTJ04 tool tray allowing you to store 4 TJ sets in a single tray
- 60mm magnetic bits holder
- A selection of 30mm impact bits

60mm magnetic impact bit holder						
1/4" Drive Impact Hex Bits:						
Length 30 mm:		3, 4, 5		PH2G		PZ1, PZ2
		ROB1, 2				TX20, TX25, TX30

Item ID: TJ1413

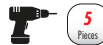
**NEW**

## IMPACT NUT SETTER SET

- Bit set that fits into the TTTJ04 tool tray allowing you to store 4 TJ sets in a single tray
- The 6 point socket includes a magnet for holding the fastening
- Suitable for use on ferrous fastenings

Impact Nut setters:		
Length 65 mm:		1/4" 7, 8, 10, 13 mm





Item ID: TJNS05



**1/4" DRIVE** **19 Pieces** **mm**

**SOCKET SET**

- Regular 6 point single hexagon sockets for a better grip
- Chrome vanadium satin finish sockets
- A selection of screwdriver and hex bits
- Supplied in the unique TengTools case with a snap lock
- Hard wearing hinge with a metal pin for longer life
- Designed and manufactured to DIN and ISO standards

1/4" Mini bits ratchet						
Magnetic bits holder, 1/4"M x 1/4" Hex adaptor						
Regular 6 point sockets:						
 mm:	8	9	10	11	12	13
1/4" Hex bits:	 4.5, 5.5, 6.5	 4, 5, 6				
	 PH1, PH2	 PZ1, PZ2				





Item ID: **T1419**



**1/4" DRIVE** **20 Pieces** **mm**

**SOCKET SET**

- Regular 6 point single hexagon sockets for a better grip
- Chrome vanadium satin finish sockets
- A selection of screwdriver and TX bits
- Supplied in the unique TengTools case with a snap lock
- Hard wearing hinge with a metal pin for longer life
- Designed and manufactured to DIN and ISO standards

1/4" Mini bits ratchet						
Magnetic bits holder, 1/4"M x 1/4" Hex adaptor						
Regular 6 point sockets:						
 mm:	5.5	6	7	8	9	10 13
1/4" Hex bits:	 4, 5.5, 6.5	 TX10, TX15, TX20				
	 PH1, PH2	 PZ1, PZ2				









Item ID: **T1420**



**28 Pieces**

**BIT SET**

- 25mm long screwdriver, hex and TX bits to suit different applications
- Supplied a bits box with a click lock lid and small enough to easily fit in the pocket

50mm quick release bit holder, 1/4" Hex x 1/4" Square drive adaptor					
1/4" Drive Hex Bits:					
Length 25 mm:	 4.5, 5.5, 6.5	 4, 5, 6	 1, 2, 3		
	 PH1, PH2, PH3	 PZ1, PZ2, PZ3	 PH2G (x2)		
	 TX10, TX15, TX20, TX25, TX30, TX40				
	 TPX20, TPX25, TPX30				









Item ID: **TM028**



**29 Pieces**

**BIT SET**

- 25mm long screwdriver, hex and TX bits to suit different applications
- Reversible mini bits ratchet
- Supplied a bits box with a click lock lid and small enough to easily fit in the pocket

50mm magnetic bit holder, 1/4" Hex x 1/4"M adaptor, 1/4" bits ratchet with 8mm ring spanner on one end					
1/4" Drive Hex Bits:					
Length 25 mm:	 4.5, 5.5, 6.5	 4, 5, 6	 1, 2, 3		
	 PH1, PH2, PH3	 PZ1, PZ2, PZ3	 PH2G (x2)		
	 TX10, TX15, TX20, TX25, TX30, TX40				
	 TPX20, TPX25, TPX30				

Item ID: **TM029**



## IMPACT BIT SET

- New design impact bits and adaptors for higher torsion
- Suitable for use with impact power tools
- Supplied in the unique TengTools bits box with a click lock lid
- Small enough to easily fit in the pocket

60mm Impact magnetic bit holder			
1/4" Hex Impact Bits: Length 30mm	PZ2	4, 5	TX20, TX25, TX30
	PH2G	1, 2	

Item ID: **TM010**



## IMPACT BIT SET

- New design impact bits and adaptors for higher torsion
- Suitable for use with impact power tools
- Supplied in the unique TengTools bits box with a click lock lid
- Small enough to easily fit in the pocket

60mm Impact magnetic bit holder	
1/4" Hex Impact Bits: Length 30mm	TX10, TX15, TX20 (x2), TX25 (x2), TX27, TX30, TX40

Item ID: **TMTX10**



## IMPACT BIT SET

- 10 piece 1/4" hex impact bit set
- All the most commonly used impact bits for the construction industry
- New design impact bits and adaptors for higher torsion
- Suitable for use with impact power tools
- Supplied in the unique TengTools bits box with a click lock lid
- Small enough to easily fit in the pocket

60mm Impact magnetic bit holder			
1/4" Hex Impact Bits: Length 30mm	PZ1, PZ2, PZ3	TX10, TX20, TX25, TX30	
	PH2	PH2G	

Item ID: **TMC010**



## IMPACT BIT SET

- 27 piece impact bit set
- Designed for higher torsion
- Includes a comprehensive range of impact bits and accessories
- Supplied in the unique TengTools bits box
- A sliding lock system helps keep the contents secure

60mm Impact magnetic bit holder, 1/4" Hex x 1/4" M adaptor							
1/4" Drive Impact nut setters - Length 65mm							
	Size:	1/4"	7	8	10		
1/4" Hex Impact Bits: Length 30mm	PH1, PH2, PH3	3, 4, 5, 6					
	PZ1, PZ2, PZ3	PH2G					
	TX10, TX15, TX20, TX25, TX40						
1/4" Hex Impact Bits: Length 89mm	TX25, TX30	1, 2, 3					
	1, 2, 3						



Item ID: **TBBSI27**



**IMPACT NUT SETTER SET**



- Designed for higher torsion
- The 6 point 1/4" AF socket includes a magnet for holding the fastening
- The 6 point metric sockets include a magnet for holding the fastening
- Suitable for use on ferrous fastenings
- Supplied in the unique TengTools storage case
- A sliding lock system helps keep the contents secure

1/4" Drive Impact nut setters - Length 65mm 						
	Size:	1/4"	7	8	10	13

Item ID: **TBNS15**

**BITS DRIVER**

- Stubby handle ideal for use in confined spaces
- For use with any 1/4" hex drive bits
- Magnetic bit holder that holds the bit in place



Item ID: **MDBH**

**BITS DRIVER**

- For use with any 1/4" hex drive bits
- Magnetic bit holder that holds the bit in place
- Overall length 193mm



Item ID: **MD193**

**BITS DRIVER**

- For use with any 1/4" hex drive bits
- Magnetic bit holder that holds the bit in place
- Hex shape shaft for use with a wrench for extra torque
- Overall length 217mm



Item ID: **MD216**

**LONG REACH FLEXIBLE BITS DRIVER**

- For use with any 1/4" hex drive bits
- Magnetic bit holder that holds the bit in place
- Flexible spring wound shaft for easier access in confined spaces
- Protected with a plastic sleeve that allows the driver to turn even when the shaft is gripped
- Overall length 555mm



Item ID: **MD907FL**







**T HANDLE BITS DRIVER**



- T drive facility for extra torque
- For use with any 1/4" hex drive bits
- Quick chuck bit holder on the long end (overall length 130mm)
- Magnetic bit holder on the short end (overall length 75mm)

Item ID: **MDTHQ**

**BITS DRIVER**

- For use with any 1/4" hex drive bits
- Quick chuck bit holder that holds the bit in place
- Hex shape shaft for use with a wrench for extra torque
- Overall length 217mm



Item ID: **MDQ217**

**BITS DRIVER**

- For use with any 1/4" hex drive bits
- Quick chuck bit holder that holds the bit in place
- Overall length 147mm



Item ID: **MDQ147**

**BITS DRIVER SET**

- Stubby handle ideal for use in confined spaces
- Includes 8 of the most commonly used bits in a bullet style holder
- Magnetic bit holder that holds the bit in place

9 Pieces



1/4" Hex Drive Double Ended Bits:		
Length 25mm		6.5, 8 mm
		PH1, PH2
		PZ1, PZ2
		4, 5 mm

Item ID: **MD908N**

**BITS DRIVER**

- For use with any 1/4" hex drive bits
- Quick chuck bit holder that holds the bit in place
- Overall length 183mm



Item ID: **MDQ183**

**RATCHETING BITS DRIVER SET**

- Stubby handle ideal for use in confined spaces
- Forward, reverse and fixed settings
- 20 teeth ratchet mechanism for 18° increments between each click
- Includes 6 bits plus a 1/4" drive socket adaptor
- Bit storage inside the handle to avoid losing bits
- Magnetic bit holder that holds the bit in place

8 Pieces

1/4" Hex x 1/4" M adaptor		
1/4" Hex Drive Double Ended Bits:		
Length 25mm		5, 7 mm
		PH1, PH2
		PZ1, PZ2



Item ID: **MDR908S**



**RATCHETING BITS DRIVER SET**

- Forward, reverse and fixed settings
- 20 teeth ratchet mechanism for 18° increments between each click
- Includes 6 bits plus a 1/4" drive socket adaptor
- Bit storage inside the handle to avoid losing bits
- Magnetic bit holder that holds the bit in place

8 Pieces

1/4" Hex x 1/4"M adaptor		
1/4" Hex Drive Double Ended Bits:		
Length 25mm		5, 7 mm
		PH1, PH2
		PZ1, PZ2



Item ID: MDR908



**ANGLED RATCHETING BITS DRIVER SET**

- Can be used straight or offset at up to 60° to create a pistol grip for added torque
- Forward, reverse and fixed settings
- 20 teeth ratchet mechanism for 18° increments between each click
- Includes 6 bits plus a 1/4" drive socket adaptor
- Bit storage inside the handle to avoid losing bits
- Quick chuck bit holder that holds the bit in place

8 Pieces

1/4" Hex x 1/4"M adaptor		
1/4" Hex Drive Double Ended Bits:		
Length 25mm		5, 7 mm
		PH1, PH2
		PZ1, PZ2





Item ID: MDRT908



**RATCHETING BITS DRIVER SET**

- Forward, reverse and fixed settings
- 20 teeth ratchet mechanism for 18° increments between each click
- 14 different screwdrivers in one
- Bit storage inside the handle to avoid losing bits
- Magnetic bit holder that holds the bit in place

8 Pieces

1/4" Hex Drive Double Ended Bits:		
Length 32mm		4 x 6 mm
		PH0 x PH3, PH1 x PH2
		PZ0 x PZ3, PZ1 x PZ2
		TX10 x TX15, TX20 x TX25



Item ID: MDR915



**RATCHETING BITS DRIVER SET**

- Forward, reverse and fixed settings
- 20 teeth ratchet mechanism for 18° increments
- Includes 6 bits plus a 1/4" drive socket adaptor
- Bit storage inside the handle to avoid losing bits
- Quick chuck bit holder that holds the bit in place

8 Pieces

1/4" Hex x 1/4"M adaptor		
1/4" Hex Drive Double Ended Bits:		
Length 25mm		5, 7 mm
		PH1, PH2
		PZ1, PZ2

Item ID: MDRQ908





1/4" DRIVE 38 Pieces

## SCREWDRIVER BIT SET

- An extensive range of 1/4" hex drive 25mm screwdriver bits
- 2 quick chuck bit driver handles included giving a choice of shaft lengths
- Removable lid and dove tail joints

147mm & 183mm Quick chuck screwdriver handles				
1/4" Hex bits:				
Length 25mm:		3.5, 5.5, 8 mm		PH1, PH2, PH3
		PZ1, PZ2, PZ3		ROB1, 2, 3
		TX10, TX15, TX20, TX25, TX30, TX40		
		TPX20, TPX25, TPX30		
Length 89mm:		2, 3, 4, 5, 6, 8		
		PH1, PH2		3, 4 mm
		PZ1, PZ2		TX10, TX20, TX25

Item ID: TTMDQ38



1/4" DRIVE 49 Pieces

## SOCKET & BITS SET

- Comprehensive selection of 25mm and 89mm 1/4" drive hex bits
- 1/4" drive regular sockets from 4 to 13mm
- Various drivers and accessories for use with bits and/or sockets

147mm Quick chuck driver, 1/4" drive ratchet head adaptor, 1/4" M x 1/4" Hex adaptor				
1/4" Drive Regular 6 point sockets:				
	mm:	4, 5, 5.5, 6, 7, 8, 9, 10, 11, 12, 13 mm		
1/4" Hex bits:				
Length 25mm:		3.5, 5.5, 8 mm		PZ1, PZ2, PZ3
		PH1, PH2, PH3		2, 3, 4, 5, 6, 8
		TX10, TX15, TX20, TX25, TX30, TX40		
		TPX20, TPX25, TPX30		ROB1, 2, 3
Length 89mm:		PH1, PH2		4 mm
		PZ1, PZ2		TX10, TX20, TX25
		2, 3, 4, 5, 6, 8		

Item ID: TTMDQ49



1/4" DRIVE 62 Pieces

## SOCKET & BITS SET

- Comprehensive selection of 25mm 1/4" drive hex bits included
- T handle bits driver with quick chuck adaptor on the long end and a magnetic bits holder on the short end

75mm Quick chuck T handle, 1/4" M x 1/4" Hex adaptor				
1/4" Drive Regular 6 point sockets:				
	mm:	5, 5.5, 6, 7, 8, 9, 10, 11, 12, 13 mm		
1/4" Drive TX-E bit sockets:				
	TX-E:	E4, E5, E6, E7, E8		
1/4" Hex bits:				
Length 25mm:		3.5, 5.5, 8 mm		PZ1, PZ2, PZ3
		PH1, PH2, PH3		2, 3, 4, 5, 6, 8
		TX6, TX7, TX8, TX9, TX10, TX15, TX20 (x3), TX25 (x3), TX27, TX30, TX40		
		TPX10, TPX15, TPX20 (x2), TPX25 (x2), TPX27, TPX30, TPX40		
		PH2G (x3)		ROB1, 2, 3

Item ID: TTTHQ62



64 Pieces

## ANGLED RATCHETING BITS DRIVER SET

- Comprehensive selection of 25mm 1/4" drive hex bits
- Ratcheting bits driver with an adjustable handle angle to create a pistol type grip driver
- Removable lid and dove tail joints

Bits driver with adjustable angle setting, 1/4" M:1/4" hex coupler adaptor				
1/4" Drive Regular 6 point sockets:				
	mm:	4, 5, 5.5, 6, 7, 8, 9, 10, 11, 12, 13 mm		
1/4" Hex bits:				
Length 25mm:		3.5, 4, 4.5, 5, 5.5 (x2), 6.5, 7, 8 mm		
		PH1 (x4), PH2 (x4), PH3 (x2)		ROB1, 2, 3
		TX6, TX7, TX8, TX9, TX10, TX15, TX20 (x3), TX25 (x3), TX27, TX30, TX40		
		PZ1, PZ2 (x3), PZ3 (x2)		2, 3, 4 (x3), 5, 6, 8

Item ID: TTMDRT64



Get organised!  
Tray Size  
TT

74 Pieces

**SCREWDRIVER BIT SET**

- An extensive range of 1/4" hex drive 25mm screwdriver bits
- Reversible, ratcheting bits driver, extension bars and adaptors included
- Removable lid and dove tail joints

Ratcheting bits handle, 6" flexible extension, 4" extension, 1/4" M:1/4" hex coupler adaptor, 1/4" F:1/4" hex coupler adaptor			
1/4" Hex bits:			
Length 25mm:	3.5, 4.0, 4.5, 5, 5.5 (x2), 6.5, 7, 8 mm		PH2G
	PH1 (x4), PH2 (x7), PH3		ROB1, 2, 3
	TX6, TX7, TX8, TX9, TX10, TX15, TX20 (x3), TX25 (x3), TX27, TX30, TX40		
	TPX10, TPX15, TPX20 (x2), TPX25 (x2), TPX27, TPX30, TPX40		
	PZ1 (x4), PZ2 (x7), PZ3		2, 3, 4, 5, 6, 8

Item ID: TTMD74



Get organised!  
Tray Size  
TT

1/4" DRIVE 76 Pieces

**SOCKET & BITS SET**

- Quick chuck bits driver and adaptor for use with bits and/or sockets

217mm Quick chuck screwdriver handle, 1/4" M x 1/4" Hex adaptor			
1/4" Drive Regular 6 point sockets:			
mm:	4, 5, 5.5, 6, 7, 8, 9, 10, 11, 12, 13 mm		
1/4" Hex bits:			
Length 25mm:	3.5, 4.0, 4.5, 5.5 (x2), 6.5, 8.0 mm		PH2G (x3)
	PH1 (x3), PH2 (x6), PH3		ROB1, 2, 3
	TX6, TX7, TX8, TX9, TX10, TX15, TX20 (x3), TX25 (x3), TX27, TX30, TX40		
	TPX10, TPX15, TPX20 (x2), TPX25 (x2), TPX27, TPX30, TPX40		
	PZ1 (x3), PZ2 (x6), PZ3		2, 3, 4, 5, 6, 8

Item ID: TTMDQ76



Get organised!  
Tray Size  
TT

1/4" DRIVE 84 Pieces

**SOCKET & BITS SET**

- Reversible ratcheting bits driver, flexible extension and adaptor for use with bits and/or sockets

Ratcheting Quick chuck screwdriver handle, 1/4" M x 1/4" Hex adaptor, 150mm flexible extension bar		
1/4" Drive Regular 6 point sockets:		
mm:	4, 5, 5.5, 6, 7, 8, 9, 10, 11, 12, 13 mm	
1/4" Hex bits:		
Length 25mm:	3.5, 4.0, 4.5, 5.5 (x2), 6.5, 8.0 mm  PH2G (x3)	
	PH1 (x3), PH2 (x6), PH3  ROB1, 2, 3	
	TX6, TX7, TX8, TX9, TX10, TX15, TX20 (x3), TX25 (x3), TX27, TX30, TX40	
	TPX10, TPX15, TPX20 (x2), TPX25 (x2), TPX27, TPX30, TPX40	
	PZ1 (x3), PZ2 (x6), PZ3	2, 3, 4, 5, 6, 8

Item ID: TTMDR84



Get organised!  
Tray Size  
TX

41 Pieces

**SOCKET & BITS SET**

- Long reach bit and socket drivers set
- Comprehensive selection of 25mm 1/4" drive hex bits
- 1/4" drive regular sockets from 4 to 13mm
- Ideal for use in difficult to reach places

555mm flexible spinner handle with 1/4" drive, 555mm flexible bits driver with 1/4" hex drive, 1/4" M:1/4" hex coupler adaptor		
1/4" Drive Regular 6 point sockets:		
mm:	4, 4.5, 5, 5.5, 6, 7, 8, 9, 10, 11, 12, 13 mm	
1/4" Hex bits:		
Length 25mm:	4, 5.5, 8 mm  3, 4, 5, 6, 8, 10	
	PH0, PH1, PH2, PH3, PH4	PZ0, PZ1, PZ2, PZ3
		TX8, TX10, TX15, TX20, TX25, TX27, TX30, TX40

Item ID: TTXMD41N



## QUICK CHUCK BITS DRIVER SET



- Various drivers and accessories for use with bits and/or sockets
- Includes the TengTools mini bits ratchet adaptor for use with the quick chuck bits driver to create a reversible 1/4" drive ratchet
- Tools are held in place using three colour pre-cut EVA foam

147mm Quick chuck driver, 1/4" drive ratchet head adaptor, 1/4" M x 1/4" Hex adaptor, 50mm Bit holder																					
1/4" Drive Regular 6 point sockets:																					
mm:	4, 5, 5.5, 6, 7, 8, 9, 10, 11, 12, 13 mm																				
1/4" Hex bits:																					
Length 25mm:	<table border="1"> <tr> <td></td> <td>3.5, 4.0, 4.5, 5.5 (x2), 6.5, 8.0 mm</td> <td></td> <td>PH2G (x3)</td> </tr> <tr> <td></td> <td>PH1 (x3), PH2 (x6), PH3</td> <td></td> <td>ROB1, 2, 3</td> </tr> <tr> <td></td> <td>TX6, TX7, TX8, TX9, TX10, TX15, TX20 (x3), TX25 (x3), TX27, TX30, TX40</td> <td></td> <td></td> </tr> <tr> <td></td> <td>TPX10, TPX15, TPX20 (x2), TPX25 (x2), TPX27, TPX30, TPX40</td> <td></td> <td></td> </tr> <tr> <td></td> <td>PZ1 (x3), PZ2 (x6), PZ3</td> <td></td> <td>2, 3, 4, 5, 6, 8</td> </tr> </table>		3.5, 4.0, 4.5, 5.5 (x2), 6.5, 8.0 mm		PH2G (x3)		PH1 (x3), PH2 (x6), PH3		ROB1, 2, 3		TX6, TX7, TX8, TX9, TX10, TX15, TX20 (x3), TX25 (x3), TX27, TX30, TX40				TPX10, TPX15, TPX20 (x2), TPX25 (x2), TPX27, TPX30, TPX40				PZ1 (x3), PZ2 (x6), PZ3		2, 3, 4, 5, 6, 8
	3.5, 4.0, 4.5, 5.5 (x2), 6.5, 8.0 mm		PH2G (x3)																		
	PH1 (x3), PH2 (x6), PH3		ROB1, 2, 3																		
	TX6, TX7, TX8, TX9, TX10, TX15, TX20 (x3), TX25 (x3), TX27, TX30, TX40																				
	TPX10, TPX15, TPX20 (x2), TPX25 (x2), TPX27, TPX30, TPX40																				
	PZ1 (x3), PZ2 (x6), PZ3		2, 3, 4, 5, 6, 8																		

Item ID: TEAMDQ78



## IMPACT DRIVER SET



- Reversible action impact driver for shifting stubborn fastenings
- 1/2" drive square drive for use with impact sockets and accessories
- Removable bit holder included for use with 5/16" hexagon drive impact bits
- Set includes four impact bits covering the most popular screw head sizes and types
- Supplied in a handy storage case

Reversible impact driver, coupler adaptor					
5/16" Hex bits: Length 36mm	<table border="1"> <tr> <td></td> <td>8, 10</td> <td></td> <td>PH2, PH3</td> </tr> </table>		8, 10		PH2, PH3
	8, 10		PH2, PH3		

Item ID: ID506



## IMPACT BITS SET



- Spare bits for the ID506 impact driver

Reversible impact driver, coupler adaptor					
5/16" Hex bits: Length 36mm	<table border="1"> <tr> <td></td> <td>8, 10</td> <td></td> <td>PH2, PH3</td> </tr> </table>		8, 10		PH2, PH3
	8, 10		PH2, PH3		

Item ID: ID506BIT



## IMPACT DRIVER SET



- Reversible action heavy duty impact driver for shifting stubborn fastenings
- 1/2" drive square drive for use with impact sockets and accessories
- Removable bit holder included for use with 5/16" hexagon drive impact bits
- Set includes 12 impact bits covering the most popular screw head sizes and types
- Supplied in a handy storage case

Heavy duty reversible impact driver, coupler adaptor, 5/16" Hex x 3/8" M adaptor									
5/16" Hex bits: Length 36mm	<table border="1"> <tr> <td></td> <td>6, 8, 10, 12</td> <td></td> <td>PH1, PH2, PH3, PH4</td> </tr> <tr> <td></td> <td>4, 5, 6, 8</td> <td></td> <td></td> </tr> </table>		6, 8, 10, 12		PH1, PH2, PH3, PH4		4, 5, 6, 8		
	6, 8, 10, 12		PH1, PH2, PH3, PH4						
	4, 5, 6, 8								

Item ID: ID515



## IMPACT BITS SET



- Spare bits for the ID515 impact driver

5/16" Hex x 3/8" M adaptor									
5/16" Hex bits: Length 36mm	<table border="1"> <tr> <td></td> <td>6, 8, 10, 12</td> <td></td> <td>PH1, PH2, PH3, PH4</td> </tr> <tr> <td></td> <td>4, 5, 6, 8</td> <td></td> <td></td> </tr> </table>		6, 8, 10, 12		PH1, PH2, PH3, PH4		4, 5, 6, 8		
	6, 8, 10, 12		PH1, PH2, PH3, PH4						
	4, 5, 6, 8								

Item ID: ID515BIT



# IMPACT DRIVERS & BITS

**STUBBORN SCREWS + BOLTS  
DON'T STAND A CHANCE!**

As a mechanic there is nothing more frustrating than wasting time and effort trying to loosen a stuck nut or bolt. Hand impact drivers are simple tools that work amazingly well for this task. Compared to a power impact tool there is far greater control with these models, they give greater access and they are so easy to use. If you can hold the tool and swing a hammer, then you can use this affordable impact tool!

After inserting the correct impact bit into the impact driver engage the stubborn screw or bolt. Apply downward pressure, while at the same time attempting to turn the impact driver in the direction you want the screw or nut to turn. Now the fun part! Whack the top of the impact driver with a hammer until the screw or nut is loosened enough to use a faster tool, such as a socket and a ratchet.





## IMPACT DRIVER BITS



- 5/16" hexagon drive impact bits
- For use with 1/2" drive impact drivers
- Designed for use with fastenings with a hexagon hole
- Use with in-hex screws or grub screws

ITEM ID:	Drive	Description	Length mm
910504	5/16" hex	4mm hex impact bit	36
910505	5/16" hex	5mm hex impact bit	36
910506	5/16" hex	6mm hex impact bit	36
910508	5/16" hex	8mm hex impact bit	36
910510	5/16" hex	10mm hex impact bit	36
920001	5/16" hex	PZ1 impact bit	36
920002	5/16" hex	PZ2 impact bit	36
920003	5/16" hex	PZ3 impact bit	36
940006	5/16" hex	6mm flat impact bit	36
940008	5/16" hex	8mm flat impact bit	36
940010	5/16" hex	10mm flat impact bit	36
940012	5/16" hex	12mm flat impact bit	36
930001	5/16" hex	PH1 impact bit	36
930002	5/16" hex	PH2 impact bit	36
930003	5/16" hex	PH3 impact bit	36
930004	5/16" hex	PH4 impact bit	36
970030	5/16" hex	TX30 impact bit	36
970040	5/16" hex	TX40 impact bit	36
970045	5/16" hex	TX45 impact bit	36
970050	5/16" hex	TX50 impact bit	36
970055	5/16" hex	TX55 impact bit	36



1/4" DRIVE 7 Pieces

## IMPACT DRIVER SET

- For use with 1/4" hexagon drive impact bits
- Supplied complete with the most popular screwdriver head sizes and types
- Screw extractor bits also included for removing damaged fastenings
- Bits are held in a handy "bullet holder" for safe storage

1/4" Drive reversible impact driver				
Screw Extractors:	1	2	3	
1/4" Hex Impact Bits: Length 50mm		PH1, PH2		5mm

Item ID: IDSE7



1/4" DRIVE 19 Pieces

## IMPACT DRIVER SET

- Includes a range of impact bits, impact sockets and screw extractors
- A complete set for removing stubborn fastenings

1/4" Drive reversible impact driver, Impact Bit Adaptor, 1/4" Hex x 1/4"M adaptor				
1/4" Drive Impact 6 point sockets:				
	Reg mm:	8	10	13
Screw Extractors:	1	2	3	
1/4" Hex Impact Bits: Length 50mm		PH2, PH3		TX25, TX30, TX40

Item ID: TTID19



Get organised™  
Tray Size  
TT

1/2" DRIVE 20 Pieces

**IMPACT DRIVER SET**

- Includes a range of impact bits for removing stubborn fastenings

Reversible impact driver, coupler adaptor, 5/16" Hex x 3/8" M adaptor			
5/16" Hex bits:	⊖ 6, 8, 10, 12	⊕ PH1, PH2, PH3, PH4	
Length 36mm	⊙ 4, 5, 6, 8	⊛ TX30, TX40, TX45, TX50, TX55	

Item ID: **TTID20**



**NEW**



Get organised™  
Tray Size  
TED

95 Pieces 

**TORQUE SCREWDRIVER SET**

- 1-5 Nm torque screwdriver with accessories
- Ratcheting bits driver set included
- Supplied in the unique TengTools double width TC tray
- Tools are held in place using three colour pre-cut EVA foam clearly showing where each tool belongs

1/4" Drive	1-5 Nm Torque screwdriver, Quick release chuck, Sliding T-bar, 6" Flexible extension, Ratcheting bits driver with assorted bits, 1/4"M:1/4" hex adaptor		
3/8" Drive	3/8" M x 5/16" Hex adaptor		
1/2" Drive	Reversible impact driver, 5/16" Hex bit adaptor		
5/16" Hex bits: Length 36mm	⊖ 6, 8, 10, 12	⊛ TX30, TX40, TX45, TX50, TX55	
	⊙ 4, 5, 6, 8	⊕ PH1, PH2, PH3, PH4	
1/4" Hex bits: Length 25mm	⊖ 3.5, 4, 4.5, 5.5 (x2), 6.5, 8	⊕ PH1 (x3), PH2 (x6), PH3	
	⊕ PZ1 (x3), PZ2 (x6), PZ3	⊙ 2, 3, 4, 5, 6, 8	
	⊛ 1, 2, 3	⊕ PH2G (x3)	
	⊛ TX6, TX7, TX8, TX9, TX10, TX15, TX20 (x3), TX25 (x3), TX27, TX30, TX40		
	⊛ TPX10, TPX15, TPX20 (x2), TPX25 (x2), TPX27, TPX30, TPX40		

Item ID: **TEDSD14**

# HEX & TX KEYS

STRONGER, HARDER AND MORE **DURABLE**

TengTools wide range of hex & TX keys consists of a range of keys made of chrome vanadium steel for industrial use and a series made of chrome-molybdenum for heavy duty usage.

## Chrome Vanadium Steel

Stronger, harder and more durable than regular carbon steels. This guarantees the high level of quality that you would expect from a TengTools item.

Our cases are designed to hold the wrenches tight enough so they didn't fall out but with a flexible enough grip that they were are still easily removed

For higher torque applications it is better to use the straight end Hex keys for maximum fastener engagement

*Available in metric & imperial sizes up to 19mm or 1/2"*





## Chrome Molybdenum Steel

It is an alloy tool steel with chromium (Cr), molybdenum (Mo), iron (Fe) and carbon (C) alloy elements. The highest quality steel that we use. It is particularly hard and strong, but also has an amount of flex. Ideal to use when more torque is required.

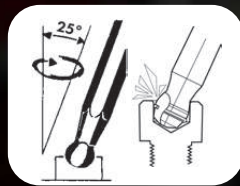

Ballpoint heads are ideal for areas that are hard to reach. Fastenings can be turned at an angle of  $25^\circ$  in a Hex key and  $20^\circ$  on a TX key.

Ergonomic as they permit a natural hand and wrist movement



## Folding Sets

A stop mechanism means the keys can be opened out individually up to  $90^\circ$  degrees for easy and stable use even under torque

Anodised aluminium handle and plastic cores ensure stability and comfort in combination with a low weight.







### HEX KEYS

- Metric hexagon key wrench
- Individually marked for size
- Ground key ends for a better finish and accurate fit
- Manufactured in chrome vanadium steel with a black phosphate finish
- Designed and manufactured to DIN 2936

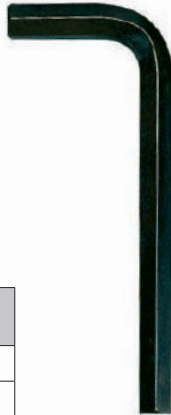

mm

ITEM ID:	Size mm	Short Arm Length mm	Long Arm Length mm
3105007	0.7	8	35
3105009	0.9	10	38
3105013	1.3	12	41
3105015	1.5	14	45
310502	2	16	50
3105025	2.5	18	56
310503	3	20	63
310504	4	25	70
3105045	4.5	26	75
310505	5	28	80
3105055	5.5	30	85
310506	6	32	90
310507	7	34	95
310508	8	36	100
310509	9	38	106
310510	10	40	112
310512	12	45	125
310514	14	56	140
310517	17	63	160
310519	19	70	180
310522	22	80	200
310527	27	100	250
310532	32	125	315
310536	36	140	355

### HEX KEYS

- Individually marked for size
- Ground key ends for a better finish and accurate fit
- Manufactured in chrome vanadium steel with a black phosphate finish
- Designed and manufactured to DIN2936



AF

ITEM ID:	Size	Short Arm Length mm	Long Arm Length mm
310102	1/16"	14	44
3101025	5/64"	15	48
310103	3/32"	17	51
3101035	7/64"	18	54
310104	1/8"	19	57
3101045	9/64"	20	60
310105	5/32"	21	64
310106	3/16"	24	70
310107	7/32"	26	76
310108	1/4"	28	83
310110	5/16"	32	95
310112	3/8"	35	108
310114	7/16"	38	121
310116	1/2"	41	133



**EXTRA LONG HEX KEYS**

- Extra long metric hexagon key wrench
- Individually marked for size
- Manufactured in chrome vanadium steel with a black phosphate finish



ITEM ID:	Size mm	Short Arm Length mm	Long Arm Length mm
3205015	1.5	14	90
320502	2	16	100
3205025	2.5	18	112
320503	3	20	126
320504	4	25	140
320505	5	28	160
320506	6	32	180
320508	8	36	200
320510	10	40	224

**CHROME MOLYBDENUM BALL POINT HEX KEYS**

- Manufactured in Chrome molybdenum steel for added strength
- Ball point end on the long key end giving access at angles of up to 25°
- Ideal for use in confined spaces
- Regular hex end on the short arm giving the ability to apply higher torque
- Individually marked for size for easier identification

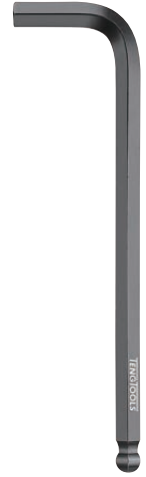

ITEM ID:	Size mm	Short Arm Length mm	Long Arm Length mm
3905015BL	1.5	14	77
3905025BL	2.5	18	90
390502BL	2	16	83
390503BL	3	20	98
390504BL	4	25	106
390505BL	5	28	118
390506BL	6	32	137
390508BL	8	36	156
390510BL	10	40	170

**BALL POINT HEX KEYS**

- Ball point end on the long key end giving access at angles of up to 25°
- Ideal for use in confined spaces
- Regular hex end on the short arm giving the ability to apply higher torque
- Manufactured in chrome vanadium steel with a black phosphate finish



ITEM ID:	Size mm	Short Arm Length mm	Long Arm Length mm
3105015BL-C	1.5	17	76
3105025BL-C	2.5	20	90
310502BL-C	2	19	83
310503BL-C	3	22	99
310504BL-C	4	28	111
310505BL-C	5	32	126
310506BL-C	6	38	143
310507BL-C	7	34	144
310508BL-C	8	44	160
310510BL-C	10	50	180

**BALL POINT HEX KEYS**

- Ball point end on the long key end giving access at angles of up to 25°
- Ideal for use in confined spaces
- Regular hex end on the short arm giving the ability to apply higher torque
- Manufactured in chrome vanadium steel with a black phosphate finish



ITEM ID:	Size mm	Short Arm Length mm	Long Arm Length mm
3101025BL	5/64"	15	82
310103BL	3/32"	17	88
310104BL	1/8"	19	96
310105BL	5/32"	21	105
310106BL	3/16"	24	114
310107BL	7/32"	26	124
310108BL	1/4"	28	135
310110BL	5/16"	32	151
310112BL	3/8"	35	170



### CHROME MOLYBDENUM BALL POINT HEX KEYS

- Manufactured in Chrome molybdenum steel for added strength
- Ball point end on the long key end giving access at angles of up to 25°
- Ideal for use in confined spaces
- Regular hex end on the short arm giving the ability to apply higher torque
- Individually marked for size for easier identification of the right size wrench

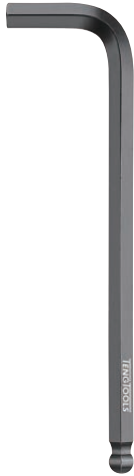

AF



ITEM ID:	Size mm	Short Arm Length mm	Long Arm Length mm
3901025BL	5/64"	15	82
390103BL	3/32"	17	88
390104BL	1/8"	19	96
390105BL	5/32"	21	105
390106BL	3/16"	24	114
390107BL	7/32"	26	124
390108BL	1/4"	28	135
390110BL	5/16"	32	151
390112BL	3/8"	35	170

### T HANDLE HEX KEYS

- Ball point end on the long key end giving access at angles of up to 25°
- Ideal for use in confined spaces
- Regular hex end on the short arm giving the ability to apply higher torque
- Manufactured in chrome molybdenum for extra strength
- Ergonomically designed bi-material handle for easy use with higher torque
- Hole in the handle for hanging or for use with a fall protection wire



mm



ITEM ID:	Size mm	Short Arm Length mm	Long Arm Length mm
510502	2	12	100
5105025	2.5	12	100
510503	3	12	100
510504	4	12	100
510505	5	15	150
510506	6	15	150
510507	7	15	150
510508	8	18	190
510510	10	20	200
510512	12	20	200



**T HANDLE HEX KEYS**

- Regular hex end on both arms giving the ability to apply higher torque
- Larger contact zone with the fastening reduces wear inside hexagon socket screws
- Manufactured in chrome molybdenum for extra strength
- Ergonomically designed bi-material handle for easy use with higher torque
- Hole in the handle for hanging or for use with a fall protection wire



ITEM ID:	Size mm	Short Arm Length mm	Long Arm Length mm
5106025	2.5	15	100
510603	3	15	100
510604	4	15	100
510605	5	18	150
510606	6	18	150
510607	7	18	150
510608	8	18	190

**T HANDLE HEX KEYS**

- Ball point end on the long key end giving access at angles of up to 25°
- Ideal for use in confined spaces
- Regular hex end on the short arm giving the ability to apply higher torque
- Manufactured in chrome molybdenum for extra strength
- Ergonomically designed bi-material handle for easy use with higher torque
- Hole in the handle for hanging or for use with a fall protection wire



ITEM ID:	Size mm	Short Arm Length mm	Long Arm Length mm
510103	3/32"	12	100
510104	1/8"	12	100
510105	5/32"	12	100
510106	3/16"	12	100
510107	7/32"	15	150
510108	1/4"	15	150
510110	5/16"	15	150



**HEX KEY SET**

- Regular hex end on both arms giving the ability to apply higher torque
- Chrome vanadium steel with a black finish
- Each key can be easily removed or used by simply twisting in it's individual holder
- Supplied with a folding plastic holder to keep the keys together

Hex Keys with Folding Plastic Holder:	
	1.5, 2, 2.5, 3, 4, 5, 6, 8, 10 mm

Item ID: **1479MMR**



### EXTRA LONG HEX KEY SET

9 Pieces **mm**

- Regular hex end on both arms giving the ability to apply higher torque
- Chrome vanadium steel with a black finish
- Each key can be easily removed or used by simply twisting in it's individual holder
- Supplied with a folding plastic holder to keep the keys together

Hex Keys with Folding Plastic Holder:	
	1.5, 2, 2.5, 3, 4, 5, 6, 8, 10 mm

Item ID: 1479MMRL



### BALL POINT HEX KEY SET

9 Pieces **mm**

- Includes 7 mm, commonly used in automotive applications
- Ball point end on the long key end giving access at angles of up to 25°
- Ideal for use in confined spaces
- Regular hex end on the short arm giving the ability to apply higher torque
- Chrome vanadium steel with a black finish
- Each key can be easily removed or used by simply twisting in it's individual holder
- Supplied with a folding plastic holder to keep the keys together

Hex Keys with Folding Plastic Holder:	
	1.5, 2, 2.5, 3, 4, 5, 6, 7, 10 mm

Item ID: 1479MMA



### BALL POINT HEX KEY SET

7 Pieces **mm**

- Ball point end on the long key end giving access at angles of up to 25°
- Ideal for use in confined spaces
- Regular hex end on the short arm giving the ability to apply higher torque
- Chrome vanadium steel with a black finish
- Each key can be easily removed or used by simply twisting in it's individual holder
- Supplied with a plastic holder to keep the keys together

Hex Keys with Plastic Holder:	
	2.5, 3, 4, 5, 6, 8, 10 mm

Item ID: 1475



### BALL POINT HEX KEY SET

9 Pieces **mm**

- Chrome molybdenum steel for extra strength
- Ball point end on the long key end giving access at angles of up to 25°
- Ideal for use in confined spaces
- Regular hex end on the short arm giving the ability to apply higher torque
- Each key can be easily removed or used by simply twisting in it's individual holder
- Supplied with a folding plastic holder to keep the keys together

Hex Keys with Folding Plastic Holder:	
	1.5, 2, 2.5, 3, 4, 5, 6, 7, 10 mm

Item ID: 1499MM



### BALL POINT HEX KEY SET

9 Pieces **mm**

- Ball point end on the long key end giving access at angles of up to 25°
- Ideal for use in confined spaces
- Regular hex end on the short arm giving the ability to apply higher torque
- Chrome vanadium steel with a black finish
- Each key can be easily removed or used by simply twisting in it's individual holder
- Supplied with a folding plastic holder to keep the keys together

Hex Keys with Folding Plastic Holder:	
	1.5, 2, 2.5, 3, 4, 5, 6, 8, 10 mm

Item ID: 1479MM





**BALL POINT HEX KEY SET**

- Ball point end on the long key end giving access at angles of up to 25°
- Ideal for use in confined spaces
- Regular hex end on the short arm giving the ability to apply higher torque
- Chrome vanadium steel with a black finish
- Each key can be easily removed or used by simply twisting in it's individual holder
- Supplied with a plastic holder to keep the keys together

Hex Keys with Plastic Holder:	
	1/8", 5/32", 3/16", 7/32", 1/4", 5/16", 3/8"

Item ID: **1474**



**BALL POINT HEX KEY SET**

- Chrome molybdenum steel for extra strength
- Ball point end on the long key end giving access at angles of up to 25°
- Ideal for use in confined spaces
- Regular hex end on the short arm giving the ability to apply higher torque
- Each key can be easily removed or used by simply twisting in it's individual holder
- Supplied with a folding plastic holder to keep the keys together

Hex Keys with Folding Plastic Holder:	
	5/64", 3/32", 1/8", 5/32", 3/16", 7/32", 1/4", 5/16", 3/8"

Item ID: **1499AF**



**BALL POINT HEX KEY SET**

- Ball point end on the long key end giving access at angles of up to 25°
- Ideal for use in confined spaces
- Regular hex end on the short arm giving the ability to apply higher torque
- Chrome vanadium steel with a black finish
- Each key can be easily removed or used by simply twisting in it's individual holder
- Supplied with a folding plastic holder to keep the keys together

Hex Keys with Folding Plastic Holder:	
	5/64", 3/32", 1/8", 5/32", 3/16", 7/32", 1/4", 5/16", 3/8"

Item ID: **1479AF**



**HEX KEY SET**

- Chrome vanadium steel with a black finish
- Retractable keys held in a fold up aluminium holder
- Designed and manufactured to DIN2936

Hex Keys with Aluminium Holder:	
	1.5, 2, 2.5, 3, 4, 5, 6 mm

Item ID: **1476NMM**



**HEX KEY SET**

- Chrome vanadium steel with a black finish
- Retractable keys held in a fold up aluminium holder
- Designed and manufactured to DIN2936

Hex Keys with Aluminium Holder:	
	2.5, 3, 4, 5, 6, 8, 10 mm

Item ID: **1476NMM1**



### HEX KEY SET

7 Pieces **mm**

- Chrome vanadium steel with a black finish
- Retractable keys held in a fold up chromed holder
- Features a fold out ring connector for use with a safety wire for added security when working at heights

Hex Keys with Chromed Holder:

1.5, 2, 2.5, 3, 4, 5, 6 mm

Item ID: 1471MM

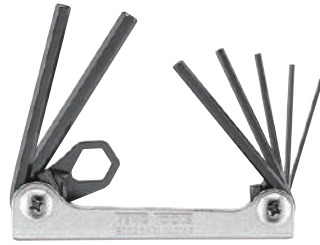

### HEX KEY SET

7 Pieces **AF**

- Chrome vanadium steel with a black finish
- Retractable keys held in a fold up chromed holder
- Features a fold out ring connector for use with a safety wire for added security when working at heights

Hex Keys with Chromed Holder:

1/16", 5/64", 3/32", 1/8", 5/32", 3/16", 7/32"

Item ID: 1471AF



### HEX KEY SET

7 Pieces **mm**

- Chrome vanadium steel with a black finish
- Retractable keys held in a fold up chromed holder
- Features a fold out ring connector for use with a safety wire for added security when working at heights

Hex Keys with Chromed Holder:

2.5, 3, 4, 5, 6, 8, 10 mm

Item ID: 1471MMA

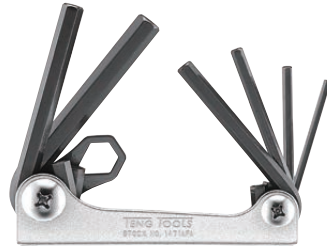

### HEX KEY SET

7 Pieces **AF**

- Chrome vanadium steel with a black finish
- Retractable keys held in a fold up chromed holder
- Features a fold out ring connector for use with a safety wire for added security when working at heights

Hex Keys with Chromed Holder:

1/8", 5/32", 3/16", 1/4", 5/16", 3/8"

Item ID: 1471AFA



### HEX KEY SET

7 Pieces **AF**

- Chrome vanadium steel with a black finish
- Retractable keys held in a fold up aluminium holder
- Designed and manufactured to DIN2936

Hex Keys with Aluminium Holder:

1/16", 5/64", 3/32", 1/8", 5/32", 3/16", 7/32"

Item ID: 1476NAF



### HEX KEY SET

10 Pieces **mm**

- Chrome vanadium steel with a black finish
- Each key can be removed by simply unscrewing from it's individual holder
- Supplied on a ring to keep the keys together

Hex Keys with Ring Holder:

1.5, 2, 2.5, 3, 4, 5, 6, 7, 8, 10 mm

Item ID: 1425



**HEX KEY SET**

10 Pieces **AF** 

- Chrome vanadium steel with a black finish
- Each key can be removed by simply unscrewing from it's individual holder
- Supplied on a ring to keep the keys together

Hex Keys with Ring Holder:	
	1/16", 5/64", 3/32", 1/8", 5/32", 3/16", 7/32", 1/4", 5/16", 3/8"



Item ID: **1424**



**T HANDLE HEX KEY SET**

7 Pieces **mm**

- Ball point end on the long key end giving access at angles of up to 25°
- Regular hex end on the short arm gives the ability to apply higher torque
- Removable lid and dove tail joints

Ball Point T-Handle Hex Drivers:	
	100 mm long: 2.5, 3, 4 mm
	150 mm long: 5, 6, 7 mm
	190 mm long: 8 mm



Item ID: **TTHEx7**



**T HANDLE HEX KEY SET**

7 Pieces **mm**

- Regular hex end on the short and long arms gives the ability to apply higher torque
- Removable lid and dove tail joints

T-Handle Hex Drivers:	
	100 mm long: 2.5, 3, 4 mm
	150 mm long: 5, 6, 7 mm
	190 mm long: 8 mm



Item ID: **TTHEx7S**



**T HANDLE HEX KEY SET**

7 Pieces **AF** 

- Ball point end on the long key end giving access at angles of up to 25°
- Regular hex end on the short and long arms gives the ability to apply higher torque
- Removable lid and dove tail joints

Ball Point T-Handle Hex Drivers:	
	100 mm long: 3/32", 1/8", 5/32"
	150 mm long: 3/16", 7/32", 1/4"
	190 mm long: 5/16"

Item ID: **TTHEx7AF**



### HEX AND TX WRENCH SET

28 Pieces mm AF

- Includes a range of ball point keys covering metric and AF hex key & TX keys
- Removable lid and dove tail joints

#### Ball Point Hex & TX Keys:

	1.5, 2, 2.5, 3, 4, 5, 6, 7, 8, 10 mm
	5/64", 3/32", 1/8", 5/32", 3/16", 7/32", 1/4", 5/16", 3/8"
	TX8, TX9, TX10, TX15, TX20, TX25, TX27, TX30, TX40

Item ID: TTHT28



### T HANDLE HEX KEY SET

7 Pieces EVA mm

- Ball point end on the long key end giving access at angles of up to 25°
- Regular hex end on the short arm giving the ability to apply higher torque
- Tools are held in place using three colour pre-cut EVA foam

#### Ball Point T-Handle Hex Drivers:

	100 mm long:	2.5, 3, 4 mm
	150 mm long:	5, 6, 7 mm
	190 mm long:	8 mm

Item ID: TEDHEX7



42 Pieces EVA mm AF

### HEX, TX AND SCREWDRIVER KEY SET

- Includes metric and inch hex keys
- TX keys and mini TX keys
- Also includes a handy fold up key set including hex, TX and screwdriver blades
- Tools are held in place using three colour pre-cut EVA foam

#### Ball Point Hex & TX Keys:

	1.5, 2, 2.5, 3, 4, 5, 6, 7, 8, 10 mm
	5/64", 3/32", 1/8", 5/32", 3/16", 7/32", 1/4", 5/16", 3/8"
	TX8, TX9, TX10, TX15, TX20, TX25, TX27, TX30, TX40

#### Mini TX Keys:

	TX6, TX7, TX8, TX9, TX10, TX15
--	--------------------------------

#### Fold Up Key Set:

4, 5, 6mm Hex, TX25, TX30, 5.5mm Flat, PH2, PZ2

Item ID: TEDHT42



### T-HANDLE HEX KEY SET

- Ball point end on the long key end giving access at angles of up to 25°
- Regular hex end on the short arm to apply higher torque to stubborn fastenings
- Supplied with a wall rack for fixing to the wall or a workbench

#### Ball Point T-Handle Hex Drivers:



	100 mm long:	2.5, 3, 4 mm
	150 mm long:	5, 6, 7 mm
	190 mm long:	8 mm

Item ID: WRHEX07



**T-HANDLE HEX KEY SET**

- Ball point end on the long key end giving access at angles of up to 25°
- Regular hex end on the short arm to apply higher torque to stubborn fastenings
- Supplied with a wall rack for fixing to the wall or a workbench
- Template and fixings included

Ball Point T-Handle Hex Drivers:			
	100 mm long:	3/32", 1/8", 5/32"	
	150 mm long:	3/16", 7/32", 1/4"	
	190 mm long:	5/16"	

Item ID: **WRHEX07AF**

**TX KEYS**

- Manufactured in chrome vanadium steel with a black phosphate finish



ITEM ID:	Size TX	For Screws M	Length mm
320008	8	2.5	16x80
320009	9	3	16x83
320010	10	3.0-3.5	17x86
320015	15	3.5-4.0	18x90
320020	20	4.0-5.0	19x95
320025	25	4.5-5.0	20x100
320027	27	4.5-6.0	22x105
320030	30	6.0-7.0	24x114
320040	40	7.0-8.0	26x124
320045	45	8.0-10.0	29x133
320050	50	10	32x152



**BALL POINT TX KEYS**

- Ball point end on the long key end giving access at angles up to 20°
- Ideal for use in confined spaces
- Regular TX end on the short arm giving the ability to apply higher torque
- Manufactured in chrome vanadium steel with a black phosphate finish



ITEM ID:	Size TX	For Screws M	Length mm
320008BL	8	2.5	16x80
320009BL	9	3	16x83
320010BL	10	3.0-3.5	17x86
320015BL	15	3.5-4.0	18x90
320020BL	20	4.0-5.0	19x95
320025BL	25	4.5-5.0	20x100
320027BL	27	4.5-6.0	22x105
320030BL	30	6.0-7.0	24x114
320040BL	40	7.0-8.0	26x124
320045BL	45	8.0-10.0	29x133
320050BL	50	10	32x152



**BALL POINT TX KEYS**

- Manufactured in chrome molybdenum steel for added strength
- Ball point end on the long key end giving access at angles up to 20°
- Ideal for use in confined spaces
- Regular hex end on the short arm giving the ability to apply higher torque
- Individually marked for size for easier identification of the right size wrench



ITEM ID:	Size mm	Short Arm Length mm	Long Arm Length mm
390908BL	8	16	80
390909BL	9	16	83
390910BL	10	17	86
390915BL	15	18	90
390920BL	20	19	95
390925BL	25	20	100
390927BL	27	22	105
390930BL	30	24	114
390940BL	40	26	124







## T HANDLE TX & TPX KEYS

- TPX type on the long key end for tamper proof TX fastenings
- Regular TX end on the short arm giving the ability to apply higher torque
- Manufactured in chrome molybdenum for extra strength
- Ergonomically designed bi-material handle for use with higher torque
- Hole in the handle for hanging or for use with a fall protection wire



ITEM ID:	Size mm	Short Arm Length mm	Long Arm Length mm
520009	TX/TPX9	12	100
520010	TX/TPX10	12	100
520015	TX/TPX15	12	100
520020	TX/TPX20	12	100
520025	TX/TPX25	15	150
520027	TX/TPX27	15	150
520030	TX/TPX30	15	150
520040	TX/TPX40	18	190
520045	TX/TPX45	20	200
520050	TX/TPX50	20	200
520055	TX/TPX55	20	200



## BALL POINT TX KEY SET



- Ball point end on the long key end giving access at angles up to 20°
- Ideal for use in confined spaces
- Regular end on the short arm giving the ability to apply higher torque
- Chrome vanadium steel with a black finish
- Each key can be easily removed or used by simply twisting in it's individual holder
- Supplied with a folding plastic holder to keep the keys together

TX Keys with Folding Plastic Holder:

	TX8, TX9, TX10, TX15, TX20, TX25, TX27, TX30, TX40
--	--

Item ID: 1479TX1



## BALL POINT TX KEY SET



- Chrome molybdenum steel for added strength
- Ball point end on the long key end giving access at angles up to 20°
- Ideal for use in confined spaces
- Regular end on the short arm giving the ability to apply higher torque
- Each key can be easily removed or used by simply twisting in it's individual holder
- Supplied with a folding plastic holder to keep the keys together

TX Keys with Folding Plastic Holder:

	TX8, TX9, TX10, TX15, TX20, TX25, TX27, TX30, TX40
--	--

Item ID: 1499TX



## TX KEY SET

- Chrome vanadium steel with a black finish
- Each key can be easily removed or used by simply twisting in it's individual holder
- Supplied with a folding plastic holder to keep the keys together

TX Keys with Folding Plastic Holder:

	TX8, TX9, TX10, TX15, TX20, TX25, TX27, TX30, TX40
--	--

Item ID: 1479TX



## TX KEY SET

- Chrome vanadium steel with a black finish
- Retractable keys held in a fold up aluminium holder

TX Keys with Aluminium Holder:

	TX9, TX10, TX15, TX20, TX25, TX27, TX30, TX40
--	---

Item ID: 1476NTX



**BALL POINT TX KEY SET**

8 Pieces 

- Ball point end giving access at angles of up to 20°, ideal for use in confined spaces
- Chrome vanadium steel with a black finish
- Retractable keys held in a fold up aluminium holder

TX Keys with Aluminium Holder:	
	TX9, TX10, TX15, TX20, TX25, TX27, TX30, TX40

Item ID: **1476NTX1**

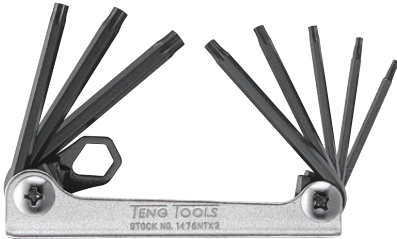

**TX KEY SET**

8 Pieces 

- Chrome molybdenum steel for added strength
- Retractable keys held in a fold up chromed holder
- Features a fold out ring connector for use with a safety wire for added security when working at heights

TX Keys with Chromed Holder:	
	TX9, TX10, TX15, TX20, TX25, TX27, TX30, TX40

Item ID: **1476NTX2**



**TX KEY SET**

7 Pieces 

- Chrome vanadium steel with a matt finish
- Each key can be removed by simply unscrewing from it's individual holder
- Supplied on a ring to keep the keys together

Hex Keys with Ring Holder:	
	TX10, TX15, TX20, TX25, TX27, TX30, TX40







Item ID: **1487**



**T HANDLE TX AND TPX KEY SET**

7 Pieces

- TPX type on the long key end for tamper proof TX fastenings
- Regular TX end on the short arm giving the ability to apply higher torque
- Removable lid and dove tail joints

T-Handle TX Drivers:	
 	100 mm long: TX/TPX10, TX/TPX15, TX/TPX20
 	150 mm long: TX/TPX25, TX/TPX27, TX/TPX30
 	190 mm long: TX/TPX40

Item ID: **TTTTX7**









**T HANDLE TX KEY SET**

7 Pieces



- TPX end on the long key end for use with tamper proof TPX fastenings
- Regular TX end on the short arm giving the ability to apply higher torque
- Tools are held in place using three colour pre-cut EVA foam

T-Handle TX Drivers:	
 	100 mm long: TX/TPX10, TX/TPX15, TX/TPX20
 	150 mm long: TX/TPX25, TX/TPX27, TX/TPX30
 	190 mm long: TX/TPX40

Item ID: **TEDTX7**



7 Pieces

## T HANDLE TX/TPX KEY SET

- TPX type on the long key end for tamper proof TX fastenings
- Regular TX end on the short arm to apply higher torque to stubborn fastenings
- Supplied with a wall rack for fixing to the wall or a workbench

T-Handle TX Drivers:	
	100 mm long: TX/TPX10, TX/TPX15, TX/TPX20
	150 mm long: TX/TPX25, TX/TPX27, TX/TPX30
	190 mm long: TX/TPX40

Item ID: **WRTX07**



8 Pieces

## ASSORTED KEY SET

- Hex, TX and screwdriver key set
- A set of 8 keys
- Chrome vanadium steel with a black finish
- Retractable keys held in a fold up aluminium holder

Ergonomically Designed Aluminium Holder			
Individual Keys:			
	mm:	1 x 5.5	
		PH1	
		PZ2	
		TX25	TX30
	mm:	4	5 6

Item ID: **1477NX**



11 Pieces

## BICYCLE TOOL KIT

- Designed for cyclists to carry easily
- Includes hexagon, TX and screwdriver keys together with a tyre lever and chain repair tool
- Chrome nickel finish
- Supplied in a handy fold up aluminium case

Ergonomically Designed Aluminium Holder, Tyre Lever, Chain Tool			
Individual Keys:			
	mm:	1 x 5.5	
		PH2	
		TX25	TX30
	mm:	4	5 6

Item ID: **1473**





# PLIERS

DESIGNED TO **MAXIMISE PERFORMANCE**

The extensive Teng Tools range includes pliers for most applications. In addition, the range includes the usual side cutters, combination pliers and slip joint pliers as well as a number of cable pliers, side cutters for cable ties, frapping pliers, nail nippers, electronic pliers, precision shears and tweezers. Two types of handles are available to choose from: slim rubber dipped as well as ergonomic TPR bi-material handles.



Made from chrome molybdenum alloy steel for maximum durability and strength

The cutting capacity is laser marked next to the cutting edge makes it easy to see which pliers you need to choose

## **TPR GRIP**

An ergonomic bi-material handle that is more comfortable in your hand

Extra support when using greater force and a lighter weight

The total length is designed to provide maximum leverage for each pair of pliers, irrespective of whether they are combination, water pump, flat or circlip pliers





## Slip Joint Pliers

Pipe grip with serrated jaws for increased grip

Simply position the upper jaw against the work piece and press the button to close the jaw - quick, simple and time saving

Made from chrome molybdenum alloy steel for maximum durability and strength

Shaped to protect the operators fingers



## VINYL GRIP

A light compact material that is textured to avoid the tool slipping in your hand. The slim design allows for greater access in tight spaces



**MEGA BITE SIDE CUTTERS**

- Chrome molybdenum steel
- 80° cutting edge angle
- Electricians style function
- Vinyl grip for easier use in pockets or tool pouches
- DIN5749



ITEM ID:	LENGTH		GRIP	High Leverage	CUTTING CAPACITY mm				g
	Inch	mm			●	◐	◑	◒	
MB441-5	5	135	Vinyl	-	1.5	1.8	2.3	4	111
MB441-6	6	155	Vinyl	-	1.6	2	2.5	4	150
MB442-5	5	140	Vinyl	Y	1.5	1.8	2.3	4	180
MB442-6	6	160	Vinyl	Y	2	2.5	3.8	4	180
MB442-7	7	180	Vinyl	Y	2	2.5	4	4	220
MB442-8	8	200	Vinyl	Y	2.5	3	4	4	240

**MEGA BITE SIDE CUTTERS**

- Chrome molybdenum steel
- 80° cutting edge angle
- Electricians style function
- TPR grip for a more secure and comfortable grip
- DIN5749



**TPR**

ITEM ID:	LENGTH		GRIP	High Leverage	CUTTING CAPACITY mm				g
	Inch	mm			●	◐	◑	◒	
MB441-5T	5	135	TPR	-	1.5	1.8	2.3	4	126
MB441-6T	6	155	TPR	-	1.6	2	2.5	4	176
MB442-6T	6	160	TPR	Y	2	2.5	3.8	4	199
MB442-8T	8	200	TPR	Y	2.5	3	4	4	275

**MEGA BITE SIDE CUTTERS**

- Heavy duty with return spring
- Chrome molybdenum steel
- 80° cutting edge angle
- High leverage function for increased cutting capacity
- Vinyl grip for easier use in pockets or tool pouches
- DIN5749



ITEM ID:	LENGTH		GRIP	High Leverage	CUTTING CAPACITY mm				g
	Inch	mm			●	◐	◑	◒	
MB442-7S	7	180	Vinyl	Y	2	2.5	4	4	250

**MEGA BITE SIDE CUTTERS**

- Chrome molybdenum steel
- 80° cutting edge angle
- Offset nose for access
- High leverage function for increased cutting capacity
- TPR grip for a more secure and comfortable grip
- DIN5749

**TPR**



ITEM ID:	LENGTH		GRIP	CUTTING CAPACITY mm				g
	Inch	mm		●	◐	◑	◒	
MB442B-8T	8	200	TPR	2.5	3	4	4	275

	Medium Hard Wire		Piano Wire		Steel Wire		Spring Steel Wire
	Soft Wire		Hard Wire		Stainless Steel Wire		Iron Wire

**MEGA BITE CABLE CUTTERS**

- Ideal for cutting copper and aluminum cable up to 60mm<sup>2</sup>
- One hand function with pitch guard for simple safe operation
- High carbon steel for durability and strength
- Vinyl grip for easier use in pockets or tool pouches



ITEM ID:	LENGTH		GRIP	CAPACITY mm <sup>2</sup>	 g
	Inch	mm			
MB444-6	6	160	Vinyl	22	181
MB444-8	8	200	Vinyl	38	322
MB444-10	10	250	Vinyl	60	381

**MEGA BITE CABLE CUTTERS**

- Ideal for cutting copper and aluminum cable up to 38mm<sup>2</sup>
- One hand function with pitch guard for simple safe operation
- High carbon steel for durability and strength
- TPR grip for a more secure and comfortable grip



**TPR**

ITEM ID:	LENGTH		GRIP	CAPACITY mm <sup>2</sup>	 g
	Inch	mm			
MB444-8T	8	208	TPR	38	347

**HEAVY DUTY CABLE CUTTER**

- Drop forged
- Chrome molybdenum alloy hardened steel cutting blades
- Compound leverage action to increase cutting power
- Simple automatic latch design for one handed operation
- Cuts copper and aluminium electrical cables up to 12mm diameter
- Bi-material handles for a comfortable grip

Length mm	Capacity mm
250	12

Item ID: **496**







**HEAVY DUTY CABLE CUTTERS**



- Ideal for cutting copper and aluminum cable up to 60mm<sup>2</sup>
- One hand function with pitch guard for simple safe operation
- Chrome molybdenum for increased durability and strength
- Vinyl grip for easier use in pockets or tool pouches

ITEM ID:	LENGTH		GRIP	CAPACITY mm <sup>2</sup>	 g
	Inch	mm			
MB445-10	10	250	Vinyl	60	412



**DO'S & DONT'S OF PLIERS**

-  Use the right plier for the material
-  Make sure the plier grips securely
-  Use the right size plier
-  Keep it clean & dry

-  Do not use a plier that does not grip or cut the material
-  Do not use on live electric



## HEAVY DUTY CUTTERS

- Chrome molybdenum alloy steel
- 80° cutting edge angle
- Induction hardened cutting edges (HRC58) for increased cutting capacity
- Return spring for easier operation
- Locking function for safe and secure storage
- Vinyl grip for easier use in pockets or tool pouches



ITEM ID:	LENGTH		GRIP	CUTTING CAPACITY mm			g
	Inch	mm		●	●●	Fe	
BC408	8	200	Vinyl	3.6	4	5.2	260

## HEAVY DUTY CUTTERS

- Chrome molybdenum alloy steel
- 80° cutting edge angle
- Induction hardened cutting edges (HRC58) for increased cutting capacity
- Return spring for easier operation
- Locking function for safe and secure storage
- TPR grip for a more secure and comfortable grip



ITEM ID:	LENGTH		GRIP	CUTTING CAPACITY mm			g
	Inch	mm		●	●●	Fe	
BC408T	8	200	TPR	3.6	4	5.2	275

## BOLT CUTTERS

- Hardened central cutting edge for durability
- 30° cutting angle for more efficient cutting
- Compound action for easier application of force
- Adjustable centering screw for increased safety when cutting
- Tubular handle with plastic grips for more comfortable use



ITEM ID:	L mm	L AF	Capacity	g
BC414	350	14"	7mm HRC15 or 4mm HRC40	1000
BC418	450	18"	8mm HRC15 or 5mm HRC40	1600
BC424	600	24"	10mm HRC15 or 6mm HRC40	2500
BC430	750	30"	13mm HRC15 or 7mm HRC40	3500
BC436	900	36"	16mm HRC15 or 8mm HRC40	5000



## BOLT CUTTER REPLACEMENT JAWS

- Replacement jaws for bolt cutters
- Includes replacement cutters and fittings
- Economical way to extend the life of the tool

ITEM ID:	For Bolt Cutters:
BC414J	BC414
BC418J	BC418
BC424J	BC424
BC430J	BC430
BC436J	BC436

**TPR**



Medium Hard Wire



Piano Wire



Steel Wire



Spring Steel Wire



Soft Wire



Hard Wire



Stainless Steel Wire





Iron Wire

**WIRE CUTTERS**

- Cuts up to 4.0mm stainless steel wire or 1.5mm spring steel cables
- Return spring mechanism for easier operation
- Vinyl grips make the tool more comfortable to use



ITEM ID:	LENGTH		GRIP	CUTTING CAPACITY mm:		g
	Inch	mm				
498-7N	7	190	Vinyl	4	1.5	270

**FLUSH CUT PLIERS**

- Special shaped cutting angle - ideal for cutting cable tie tails flush
- Suitable for cutting other soft materials such as lead, tin, etc.
- Return spring for easier operation
- Vinyl grip for easier use in pockets or tool pouches





ITEM ID:	LENGTH		GRIP	g
	Inch	mm		
MB541-5	5	125	Vinyl	100
MB541-6	6	150	Vinyl	143
MB541-7	7	180	Vinyl	227



**END NIPPERS**

- Chrome molybdenum alloy steel for durability and strength
- Vinyl grip for easier use in pockets or tool pouches
- DIN5748



ITEM ID:	LENGTH		GRIP	CUTTING CAPACITY mm			g
	Inch	mm					
MB448-6	6	160	Vinyl	1.6	1.8	3.4	200
MB448-8	8	200	Vinyl	1.6	1.8	3.4	250







## CARPENTERS PLIERS

- 85° cutting edge angle
- Vinyl grip for easier use in pockets or tool pouches



ITEM ID:	LENGTH		GRIP	CUTTING CAPACITY mm			g
	Inch	mm					
MB489-7	7	180	Vinyl	1.6	2	262	
MB489-8	8	200	Vinyl	1.8	2.2	283	

## TOWER PINCER PLIERS

- Chrome molybdenum alloy steel for durability and strength
- Vinyl grip for easier use in pockets or tool pouches



ITEM ID:	LENGTH		GRIP	CUTTING CAPACITY mm			g
	Inch	mm					
MB449-9	9	220	Vinyl	1.8	2	3.4	355
MB449-10	10	250	Vinyl	2	2.2	3.8	408
MB449-11	11	280	Vinyl	2.5	3	4	492

## CUTTING CAPACITY FOR PLIERS

The cutting capacity is laser marked next to the cutting edge of Teng Tools pliers which makes it easier to see which pliers you need to choose at a glance.



- Piano Wire
- Hard Wire
- Medium Hard Wire
- Soft Wire
- Steel Wire
- Stainless Steel Wire
- Spring Steel Wire
- Iron Wire

**COMBINATION PLIERS**

- Features a pipe grip with serrated jaw for a more secure grip
- Chrome molybdenum alloy steel for durability and strength
- 80° cutting edge angle
- Vinyl grip for easier use in pockets or tool pouches
- DIN5746



ITEM ID:	LENGTH		GRIP	High Leverage	CUTTING CAPACITY mm			g
	Inch	mm			●	◐	◑	
MB451-7	7	180	Vinyl	-	1.8	2	3.8	195
MB451-8	8	200	Vinyl	-	2	2.2	4	253
MB452-6	6	160	Vinyl	Y	1.6	1.8	3.4	200
MB452-7	7	180	Vinyl	Y	1.8	2	3.8	210
MB452-8	8	200	Vinyl	Y	2	2.2	4	240
MB452-9	9	225	Vinyl	Y	2	2.2	4	380

**COMBINATION PLIERS**

- High leverage function for increased gripping and cutting power
- Features a pipe grip with serrated jaw for a more secure grip
- Chrome molybdenum alloy steel for durability and strength
- 80° cutting edge angle
- TPR grip for a more secure and comfortable grip
- DIN5746

**TPR**



ITEM ID:	LENGTH		GRIP	High Leverage	CUTTING CAPACITY mm			g
	Inch	mm			●	◐	◑	
MB452-6T	6	160	TPR	Y	1.6	1.8	3.4	210
MB452-7T	7	180	TPR	Y	1.8	2	3.8	220
MB452-8T	8	200	TPR	Y	2	2.2	4	266

**LONG NOSE PLIERS**

- Long straight jaws for easier access
- Jaws with a serrated grip for increased gripping power
- Chrome molybdenum alloy steel for durability and strength
- 80° cutting edge angle
- Vinyl grip for easier use in pockets or tool pouches
- DIN5745



ITEM ID:	LENGTH		GRIP	CUTTING CAPACITY mm			g
	Inch	mm		●	◐	◑	
MB461-5	5	140	Vinyl	1	1.5	2.5	130
MB461-6	6	160	Vinyl	1	1.5	2.5	130
MB461-8	8	200	Vinyl	1.5	1.8	2.8	180

**LONG NOSE PLIERS**

- Long straight jaws for easier access
- Jaws with a serrated grip for increased gripping power
- Chrome molybdenum alloy steel for durability and strength
- 80° cutting edge angle
- TPR grip for a more secure and comfortable grip
- DIN5745

**TPR**



ITEM ID:	LENGTH		GRIP	CUTTING CAPACITY mm			g
	Inch	mm		●	◐	◑	
MB461-6T	6	160	TPR	1	1.5	2.5	139
MB461-8T	8	200	TPR	1.5	1.8	2.8	185



## BENT LONG NOSE PLIERS

- Long 45° offset jaws for easier access
- Jaws with a serrated grip for increased gripping power
- Chrome molybdenum alloy steel for durability and strength
- 80° cutting edge angle
- Vinyl grip for easier use in pockets or tool pouches
- DIN5745



ITEM ID:	LENGTH		GRIP	CUTTING CAPACITY mm			g
	Inch	mm		●	◐	◑	
MB463-5	5	140	Vinyl	1	1.5	2.5	150
MB463-6	6	160	Vinyl	1	1.5	2.5	160
MB463-8	8	200	Vinyl	1.5	1.8	2.8	167

## BENT LONG NOSE PLIERS

- Long 45° offset jaws for easier access
- Jaws with a serrated grip for increased gripping power
- Chrome molybdenum alloy steel for durability and strength
- 80° cutting edge angle
- TPR grip for a more secure and comfortable grip
- DIN5745



**TPR**

ITEM ID:	LENGTH		GRIP	CUTTING CAPACITY mm			g
	Inch	mm		●	◐	◑	
MB463-8T	8	200	TPR	1.5	1.8	2.8	186

## FLAT NOSE PLIERS

- Long straight jaws for easier access
- Chrome molybdenum alloy steel for durability and strength
- Vinyl grip for easier use in pockets or tool pouches
- DIN5745



ITEM ID:	LENGTH		GRIP	g
	Inch	mm		
MB464-6	6	165	Vinyl	120

## FLAT NOSE PLIERS

- Long straight jaws for easier access
- Chrome molybdenum alloy steel for durability and strength
- TPR grip for a more secure and comfortable grip
- DIN5745

**TPR**



ITEM ID:	LENGTH		GRIP	g
	Inch	mm		
MB464-6T	6	165	TPR	120

## ROUND NOSE PLIERS

- Polished finish with a smooth tip
- Return spring for easier use
- Chrome molybdenum alloy steel for durability and strength
- Vinyl grip for easier use in pockets or tool pouches



ITEM ID:	LENGTH		GRIP	g
	Inch	mm		
MB465-6	6	150	Vinyl	170



Medium Hard Wire



Piano Wire



Steel Wire



Spring Steel Wire



Soft Wire



Hard Wire



Stainless Steel Wire



Iron Wire

### LONG REACH PLIERS

- The long reach enables the plier to reach in to recessed areas
- Body hardness HRC43-48 for long lasting use
- Vinyl grips make the tool more comfortable to use

ITEM ID:	LENGTH		GRIP	TYPE	 g
	Inch	mm			
AT096	11	275	Vinyl	Straight	300
AT097	11	275	Vinyl	Angled 45°	300



### WATER PUMP PLIERS

- Pipe grip with serrated jaws for increased grip
- Chrome vanadium steel construction
- TPR grip for a more secure and comfortable grip

**TPR**

ITEM ID:	LENGTH		GRIP	CAPACITY mm	 g
	Inch	mm			
MB481-7T	7	180	TPR	3-25	344
MB481-10T	10	250	TPR	3-38	371



### GROOVE JOINT PLIERS

- Serrated jaws for a more secure grip
- Non slip groove joints for use with higher force
- Chrome vanadium with a polished head
- Vinyl grip for easier use in pockets or tool pouches

ITEM ID:	LENGTH		GRIP	CAPACITY mm	 g
	Inch	mm			
MB410	10	250	Vinyl	45	425
MB412	12	300	Vinyl	60	600
MB416	16	400	Vinyl	90	1330



### QUICK SET WATER PUMP PLIERS

- Simply position the upper jaw against the work piece and press the button to close the jaw - quick, simple and time saving
- Pipe grip with serrated jaws for increased grip
- Shaped to protect the operators fingers

ITEM ID:	LENGTH		GRIP	JAWS	CAPACITY mm	 g
	Inch	mm				
MB481-10Q	10	250	Vinyl	CHROME VANADIUM	3-38	380



### WATER PUMP PLIERS

- Pipe grip with serrated jaws for increased grip
- Chrome vanadium steel construction
- Vinyl grip for easier use in pockets or tool pouches

ITEM ID:	LENGTH		GRIP	CAPACITY mm	 g
	Inch	mm			
MB481-7	7	180	Vinyl	3-25	159
MB481-10	10	250	Vinyl	3-38	175





**QUICK SET WATER PUMP PLIERS**

- Simply position the upper jaw against the work piece and press the button to close the jaw - quick, simple and time saving
- Pipe grip with serrated jaws for increased grip
- Shaped to protect the operators fingers



ITEM ID:	LENGTH		GRIP	JAWS	CAPACITY mm	CAPACITY g
	Inch	mm				
MB482-7Q	7	190	Vinyl	HRC60 HARDENED	3-25	182
MB482-10Q	10	250	Vinyl	HRC60 HARDENED	3-38	335

**QUICK SET WATER PUMP PLIERS**

- Simply position the upper jaw against the work piece and press the button to close the jaw - quick, simple and time saving
- Pipe grip with serrated jaws for increased grip
- Shaped to protect the operators fingers

**TPR**



ITEM ID:	LENGTH		GRIP	JAWS	CAPACITY mm	CAPACITY g
	Inch	mm				
MB481-10TQ	10	250	TPR	CHROME VANADIUM	3-38	405

**QUICK SET WATER PUMP PLIERS**

- Simply position the upper jaw against the work piece and press the button to close the jaw - quick, simple and time saving
- Pipe grip with serrated jaws for increased grip
- Shaped to protect the operators fingers

**TPR**



ITEM ID:	LENGTH		GRIP	JAWS	CAPACITY mm	CAPACITY g
	Inch	mm				
MB482-10TQ	10	250	TPR	HRC60 HARDENED	3-38	359



4 Pieces

**PLIER SET**

- Vinyl grip for easier use in pockets or tool pouches
- All the most commonly used pliers in one set

PLIERS:	
SIDE CUTTER	6" / 155 mm
COMBINATION	7" / 180 mm
LONG NOSE	8" / 200 mm
WATER PUMP	10" / 250 mm

Item ID: **TT440**





4 Pieces **TPR**

**PLIER SET**

- TPR grip for a more secure and comfortable grip
- All the most commonly used pliers in one set

PLIERS:	
SIDE CUTTER	6" / 155 mm
COMBINATION	7" / 180 mm
LONG NOSE	8" / 200 mm
WATER PUMP	10" / 250 mm

Item ID: **TT440-T**



8 Pieces

**PLIER SET**

- Vinyl grip for easier use in pockets or tool pouches
- All the most commonly used pliers in one set
- Supplied in the unique TengTools double width TC tray

PLIERS:		PLIERS:	
HEAVY DUTY SIDE CUTTER	6" / 160 mm	LONG NOSE	6" / 160 mm
	8" / 200 mm		8" / 200 mm
HIGH LEVERAGE COMBINATION	6" / 160 mm	WATER PUMP	7" / 180 mm
	8" / 200 mm		10" / 250 mm

Item ID: **TTD441**



8 Pieces **TPR**

**PLIER SET**

- TPR grip for a more secure and comfortable grip
- All the most commonly used pliers in one set
- Supplied in the unique TengTools double width TC tray

PLIERS:		PLIERS:	
HEAVY DUTY SIDE CUTTER	6" / 160 mm	LONG NOSE	6" / 160 mm
	8" / 200 mm		8" / 200 mm
HIGH LEVERAGE COMBINATION	6" / 160 mm	WATER PUMP	7" / 180 mm
	8" / 200 mm		10" / 250 mm

Item ID: **TTD441-T**



2 Pieces

**PLIER & WRENCH SET**

- 2 tools for gripping even the most stubborn nuts and bolts
- Supplied in the unique TengTools drawer width TTX tray

PLIERS:	
QUICK ACTION WATER PUMP	10" / 250 mm
WRENCHES:	
ALIGATOR ADJUSTABLE	8" / 200 mm

Item ID: **TTXMB02**





5 Pieces **TPR** **EVA**

**PLIER SET**

- TPR grip for a more secure and comfortable grip
- All the most commonly used pliers in one set
- Supplied in the unique TengTools double width TC tray
- Tools are held in place using three colour pre-cut EVA foam clearly showing where each tool belongs

PLIERS:	
SIDE CUTTER	5" / 135 mm
HEAVY DUTY SIDE CUTTERS	8" / 200 mm
HIGH LEVERAGE COMBINATION	8" / 200 mm
LONG NOSE	8" / 200 mm
WATER PUMP	10" / 250 mm

Item ID: **TED441-T**



2 Pieces **EVA**

**PLIER & WRENCH SET**

- 2 tools for gripping even the most stubborn nuts and bolts
- Supplied in the unique TengTools drawer width TEX tray
- Tools are held in place using three colour pre-cut EVA foam clearly showing where each tool belongs

PLIERS:	
QUICK ACTION WATER PUMP	10" / 250 mm
WRENCHES:	
ALLIGATOR ADJUSTABLE	8" / 200 mm

Item ID: **TEXMB02**



4 Pieces **TPR**

**PLIER SET**

- TPR grip for a more secure and comfortable grip
- All the most commonly used pliers in one set
- Supplied with a wall rack for fixing to the wall or a workbench

PLIERS:	
SIDE CUTTER	6" / 155 mm
HIGH LEVERAGE COMBINATION	7" / 180 mm
LONG NOSE	8" / 200 mm
WATER PUMP	10" / 250 mm

Item ID: **WRMB04**



5 Pieces

**PLIER SET**

- All the most commonly used pliers in one set
- All the pliers have a vinyl grip for easier use in pockets or tool pouches
- Supplied in a heavy duty tool roll storage wallet

PLIERS:	
SIDE CUTTER	4 1/2" / 110 mm
	6" / 155 mm
COMBINATION	7" / 180 mm
LONG NOSE	8" / 200 mm
WATER PUMP	10" / 250 mm

Item ID: **445W**

**PIPE WRENCHES**

- Lightweight aluminium construction
- Sturdy design with steel jaws and adjustment thread
- One hand operation



ITEM ID:	Length		Capacity		g
	mm	AF	mm	AF	
PWC12	300	12"	43	1-11/16"	670
PWC14	350	14"	50	1-31/32"	860
PWC18	450	18"	60	2-23/64"	1390
PWC24	600	24"	76	3"	2220
PWC36	900	36"	102	4-1/64"	4030

**WIRE STRIPPING PLIER**

- Medium carbon alloy steel construction
- With adjuster screw to suit wire diameters from 0.2 to 4.5mm
- Return spring for easier operation
- TPR grip for a more secure and comfortable grip

**TPR**



ITEM ID:	LENGTH		GRIP	CAPACITY	g
	Inch	mm			
MB499-7T	6	155	TPR	0.2 - 4.5	175

**MINI SIDE CUTTER**

- 68° cutting angle
- Cuts up to 0.8mm wire
- High carbon steel construction
- Return spring for easier operation
- Vinyl grip for easier use in pockets or tool pouches



ITEM ID:	LENGTH		GRIP	CAPACITY	g
	Inch	mm			
MBM441	5	125	Vinyl	0.8	67

**MINI END CUTTER**

- 68° cutting angle
- Cuts up to 0.8mm wire
- High carbon steel construction
- Return spring for easier operation
- Vinyl grip for easier use in pockets or tool pouches



ITEM ID:	LENGTH		GRIP	CAPACITY	g
	Inch	mm			
MBM449	4 1/2	110	Vinyl	0.8	70

**MINI LONG NOSE PLIER**

- Long straight jaws for easier access
- 68° cutting angle
- Cuts up to 0.8mm wire
- High carbon steel construction
- Return spring for easier operation
- Vinyl grip for easier use in pockets or tool pouches



ITEM ID:	LENGTH		GRIP	CAPACITY	g
	Inch	mm			
MBM461	5	125	Vinyl	0.8	81





**MINI FLAT NOSE PLIER**

- Long straight jaws for easier access
- High carbon steel construction
- Return spring for easier operation
- Vinyl grip for easier use in pockets or tool pouches



ITEM ID:	LENGTH		GRIP	g
	Inch	mm		
MBM464	5	125	Vinyl	85

**MINI BENT NOSE PLIER**

- Long offset straight jaws for easier access
- High carbon steel construction
- Return spring for easier operation
- Vinyl grip for easier use in pockets or tool pouches



ITEM ID:	LENGTH		GRIP	g
	Inch	mm		
MBM469	6	150	Vinyl	78

**MINI ROUND NOSE PLIER**

- Long straight jaws for easier access
- High carbon steel construction
- Return spring for easier operation
- Vinyl grip for easier use in pockets or tool pouches



ITEM ID:	LENGTH		GRIP	g
	Inch	mm		
MBM467	5	125	Vinyl	71



**MINI PLIERS & SCREWDRIVER SET**

- Mini screwdrivers feature a rotating end piece for easier use when "transporting" the fastening
- Mini pliers feature high carbon steel construction and vinyl grip handles

MINI SCREWDRIVER:			
mm:	2.0 x 40	2.4 x 40	3.0 x 40
mm:	PH00 x 40	PH0 x 40	PH1 x 40
mm:	TX6 x 40	TX7 x 40	TX8 x 40
	TX9 x 40	TX10 x 40	TX15 x 40
MINI PLIERS:			
5"			SIDE CUTTER
4 1/2"			END CUTTER
5"			LONG NOSE PLIER
5"			FLAT NOSE PLIER

Item ID: TTM116

**MINI NEEDLE NOSE PLIER**

- Long straight jaws for easier access
- High carbon steel construction
- Return spring for easier operation
- Vinyl grip for easier use in pockets or tool pouches



ITEM ID:	LENGTH		GRIP	g
	Inch	mm		
MBM468	6	150	Vinyl	75

**SELF LOCKING PLIERS**

- Serrated jaw for improved grip
- Made from special grade stainless steel suitable for use in special environments
- Three step lock function and precision joint construction for precise gripping
- Matt finish
- Hot drop forged construction for greater strength and durability



ITEM ID:	LENGTH		JAW TYPE		g
	Inch	mm			
SLP1160	6	160	Straight	Serrated	43
SLP2180	7	180	Straight	Serrated	45
SLP3160	6	160	Curved	Serrated	50
SLP3180	7	180	Curved	Serrated	58

**TWEEZERS**

- Serrated jaw for improved grip
- Made from special grade stainless steel suitable for use in special environments
- Matt finish
- Hot drop forged construction for greater strength and durability



ITEM ID:	LENGTH mm	TIP TYPE		g
		Straight	Serrated	
TW1160	160	Straight	Serrated	37
TW1180	180	Straight	Serrated	37

**TWEEZERS**

- Serrated jaw for improved grip
- Made from special grade stainless steel suitable for use in special environments
- Matt finish
- Hot drop forged construction for greater strength and durability



ITEM ID:	LENGTH mm	TIP TYPE		g
		Bent	Serrated	
TW2125	125	Bent	Serrated	29

**TWEEZERS**

- Smooth jaw for a more delicate grip
- Made from special grade stainless steel suitable for use in special environments
- Matt finish
- Hot drop forged construction for greater strength and durability



ITEM ID:	LENGTH mm	TIP TYPE		g
		Bent	Smooth	
TW2160	160	Bent	Smooth	42

**TWEEZERS**

- Needle tips for a more precise grip
- Made from special grade stainless steel suitable for use in special environments
- Matt finish
- Hot drop forged construction for greater strength and durability



ITEM ID:	LENGTH mm	TIP TYPE		g
		Z Shape	Needle Tip	
TW2180	170	Z Shape	Needle Tip	35



**CIRCLIP PLIER SET**

- 10-50mm capacity covering a wide range of applications
- Interchangeable heads for bent or straight with 1.2 and 1.5mm tips
- Inner or Outer fitting giving 8 different possible combinations
- Magnetic tips to help hold the circlip when inserting or removing, especially useful with smaller circlips
- A return spring gives smooth and easy operation
- Vinyl grips make the tool more comfortable to use

HANDLE:		
REVERSIBLE, SPRING LOADED HANDLE WITH LOCKING PIN		
MAGNETIC TIPS:		
STRAIGHT	INNER / OUTER	1.2 mm TIP
	INNER / OUTER	1.5 mm TIP
45° TIP	INNER / OUTER	
90° TIP	INNER / OUTER	

Item ID: 480





**CIRCLIP PLIERS**

- Invisible return spring for easier operation
- For use with inner type circlips or snap rings
- 1.8mm bearing steel tips for heavy duty applications
- Non slip tip angle enabling the ring to stock securely to the tip when compressing or expanding the circlip
- 19 to 60mm capacity
- Chrome vanadium construction
- Vinyl grip for easier use in pockets or tool pouches
- DIN5254

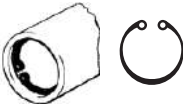

ITEM ID:	LENGTH		TYPE	GRIP	TIP mm	CAPACITY mm	g	
	Inch	mm						
MBE470-7	7	185	Straight	Inner	Vinyl	1.8	19-60	150

**CIRCLIP PLIERS**

- Invisible return spring for easier operation
- For use with outer type circlips or snap rings
- 1.8mm bearing steel tips for heavy duty applications
- Non slip tip angle enabling the ring to stock securely to the tip when compressing or expanding the circlip
- 19 to 60mm capacity
- Chrome vanadium construction
- Vinyl grip for easier use in pockets or tool pouches
- DIN5254



ITEM ID:	LENGTH		TYPE	GRIP	TIP mm	CAPACITY mm	g	
	Inch	mm						
MBE472-7	7	185	Straight	Outer	Vinyl	1.8	19-60	170

**CIRCLIP PLIERS**

- Invisible return spring for easier operation
- For use with inner type circlips or snap rings
- 1.8mm bearing steel tips for heavy duty applications
- Non slip tip angle enabling the ring to stock securely to the tip when compressing or expanding the circlip
- 19 to 60mm capacity
- Chrome vanadium construction
- Vinyl grip for easier use in pockets or tool pouches
- DIN5254

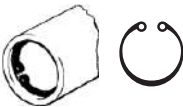

ITEM ID:	LENGTH		TYPE	GRIP	TIP mm	CAPACITY mm	g	
	Inch	mm						
MBE471-7	7	170	Bent	Inner	Vinyl	1.8	19-60	150

**CIRCLIP PLIERS**

- Invisible return spring for easier operation
- For use with outer type circlips or snap rings
- 1.8mm bearing steel tips for heavy duty applications
- Non slip tip angle enabling the ring to stock securely to the tip when compressing or expanding the circlip
- 19 to 60mm capacity
- Chrome vanadium construction
- Vinyl grip for easier use in pockets or tool pouches
- DIN5254



ITEM ID:	LENGTH		TYPE	GRIP	TIP mm	CAPACITY mm	g	
	Inch	mm						
MBE473-7	7	170	Bent	Outer	Vinyl	1.8	19-60	170

**CIRCLIP PLIERS**

- For use with inner type circlips or snap rings
- Chrome vanadium construction
- Return spring for easier use
- Vinyl grip for easier use in pockets or tool pouches
- DIN5254

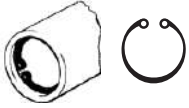

ITEM ID:	LENGTH		TYPE		GRIP	TIP mm	CAPACITY mm	g
	Inch	mm						
MB470-5	5	130	Straight	Inner	Vinyl	1.25	10-25	100
MB470-7	7	175	Straight	Inner	Vinyl	1.8	19-60	134
MB470-9	9	225	Straight	Inner	Vinyl	2.25	40-100	160

**CIRCLIP PLIERS**

- For use with inner type circlips or snap rings
- Chrome vanadium construction
- Return spring for easier use
- Vinyl grip for easier use in pockets or tool pouches
- DIN5254



ITEM ID:	LENGTH		TYPE		GRIP	TIP mm	CAPACITY mm	g
	Inch	mm						
MB471-5	5	130	Bent	Inner	Vinyl	1.25	10-25	100
MB471-7	7	175	Bent	Inner	Vinyl	1.8	19-60	134
MB471-9	9	225	Bent	Inner	Vinyl	2.25	40-100	160

**CIRCLIP PLIERS**

- For use with outer type circlips or snap rings
- Chrome vanadium construction
- Return spring for easier use
- Vinyl grip for easier use in pockets or tool pouches
- DIN5254



ITEM ID:	LENGTH		TYPE		GRIP	TIP mm	CAPACITY mm	g
	Inch	mm						
MB472-5	5	130	Straight	Outer	Vinyl	1.25	10-25	100
MB472-7	7	175	Straight	Outer	Vinyl	1.8	19-60	134
MB472-9	9	225	Straight	Outer	Vinyl	2.25	40-100	160

**CIRCLIP PLIERS**

- For use with outer type circlips or snap rings
- Chrome vanadium construction
- Return spring for easier use
- Vinyl grip for easier use in pockets or tool pouches
- DIN5254



ITEM ID:	LENGTH		TYPE		GRIP	TIP mm	CAPACITY mm	g
	Inch	mm						
MB473-5	5	130	Bent	Outer	Vinyl	1.25	10-25	100
MB473-7	7	175	Bent	Outer	Vinyl	1.8	19-60	134
MB473-9	9	225	Bent	Outer	Vinyl	2.25	40-100	160





## CIRCLIP PLIER SET

- Invisible return spring for easier operation
- For use with inner and outer type circlips or snap rings
- 1.8mm bearing steel tips for heavy duty applications
- Non slip tip angle enabling the ring to stock securely to the tip when compressing or expanding the circlip
- 19 to 60mm capacity
- Chrome vanadium construction
- Return spring for easier use
- Vinyl grip for easier use in pockets or tool pouches
- DIN5254

7" CIRCLIP PLIERS:		CAPACITY
STRAIGHT	INNER	19 - 60 mm
	OUTER	19 - 60 mm
BENT	INNER	19 - 60 mm
	OUTER	19 - 60 mm



INVISIBLE RETURN SPRING

Item ID: TT474-7E



## CIRCLIP PLIER SET

- For use with inner and outer type circlips or snap rings
- 1.25mm tip and 10 to 25mm capacity
- Chrome vanadium construction
- Return spring for easier use
- Vinyl grip for easier use in pockets or tool pouches
- DIN5254

5" / 130 mm CIRCLIP PLIERS:		CAPACITY
STRAIGHT	INNER	10 - 25 mm
	OUTER	10 - 25 mm
BENT	INNER	10 - 25 mm
	OUTER	10 - 25 mm

Item ID: TT474-5



## CIRCLIP PLIER SET

- For use with inner and outer type circlips or snap rings
- 1.8mm tip and 19 to 60mm capacity
- Chrome vanadium construction
- Return spring for easier use
- Vinyl grip for easier use in pockets or tool pouches
- DIN5254

7" / 175 mm CIRCLIP PLIERS:		CAPACITY
STRAIGHT	INNER	19 - 60 mm
	OUTER	19 - 60 mm
BENT	INNER	19 - 60 mm
	OUTER	19 - 60 mm

Item ID: TT474-7



## CIRCLIP PLIER SET

- For use with inner and outer type circlips or snap rings
- 2.25mm tip and 40 to 100mm capacity
- Chrome vanadium construction
- Return spring for easier use
- Vinyl grip for easier use in pockets or tool pouches
- DIN5254

9" / 225 mm CIRCLIP PLIERS:		CAPACITY
STRAIGHT	INNER	40 - 100 mm
	OUTER	40 - 100 mm
BENT	INNER	40 - 100 mm
	OUTER	40 - 100 mm

Item ID: TTX474-9

# POWER GRIP PLIERS

FOR THE **ULTIMATE GRIP**

An extensive range of power grip pliers standard and tapered in a broad size range together with a wide selection of welding power grip pliers. All available with anti-pinch release arms.

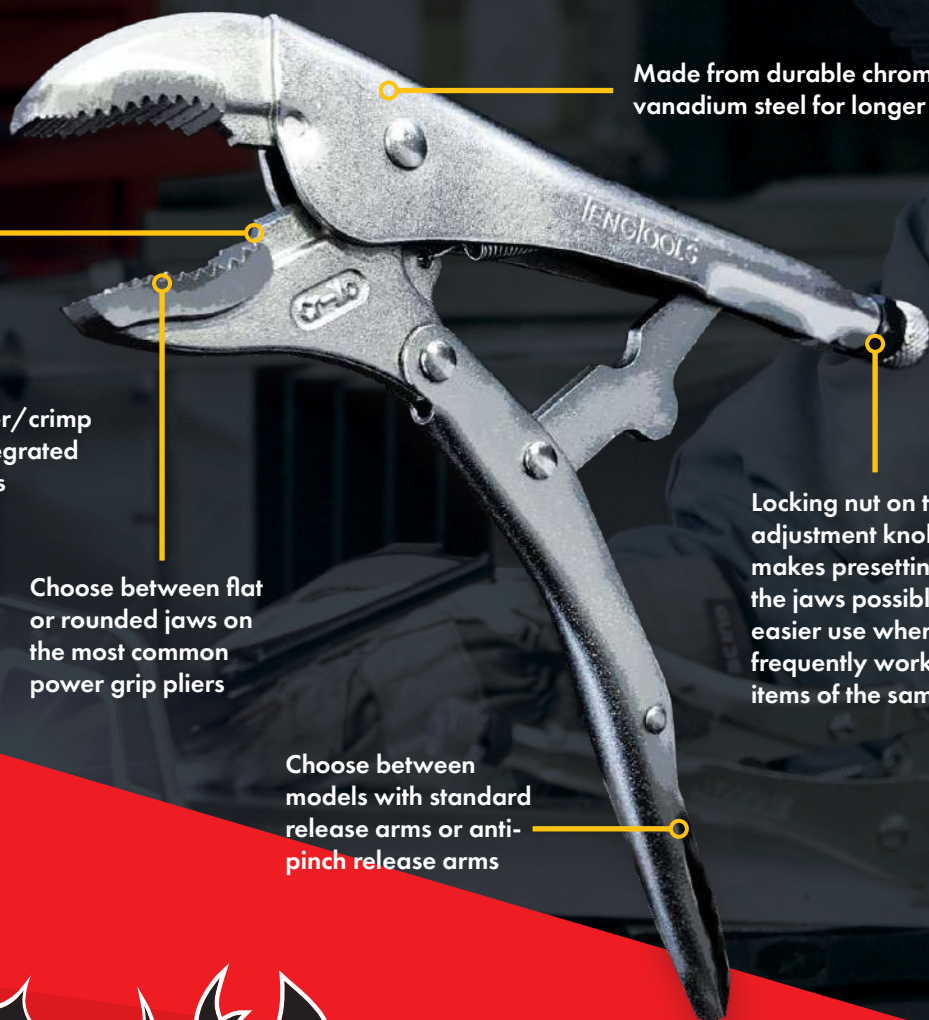

Made from durable chrome vanadium steel for longer life

Wire cutter/crimp action integrated in the jaws

Choose between flat or rounded jaws on the most common power grip pliers

Locking nut on the adjustment knob makes presetting the jaws possible for easier use when you frequently work with items of the same size

Choose between models with standard release arms or anti-pinch release arms





## POWER GRIP PLIERS

- Self locking with release lever
- With locking nut on adjustment knob for pre-setting, ideal for repeated use
- Wire cutter and crimper function
- Chrome molybdenum



ITEM ID:	LENGTH		CAPACITY mm	🏋️ g
	Inch	mm		
401-4	4	100	25	75
401-5	5	125	28	180
401-7	7	180	38	345
401-10	10	250	47	514
401-12	12	300	50	680

## POWER GRIP PLIERS

- Narrow jaw for use in confined spaces
- Self locking with non pinch, one handed operation release lever
- With locking nut on adjustment knob for pre-setting, ideal for repeated use
- Wire cutter and crimper function
- Chrome molybdenum



ITEM ID:	LENGTH		CAPACITY mm	JAW WIDTH mm	🏋️ g
	Inch	mm			
404-65	6	160	35	6	185

## POWER GRIP PLIERS

- Self locking with release lever
- With locking nut on adjustment knob for pre-setting, ideal for repeated use
- Chrome molybdenum



ITEM ID:	LENGTH		CAPACITY mm	🏋️ g
	Inch	mm		
401-10F	10	250	45	527
401-12F	12	300	52	693

## OIL FILTER REMOVER PLIER

- 53-118mm capacity to suit most oil filters
- Two stage grip areas on the jaws for added versatility
- Ideal for removing and installing objects of many shapes when a tight grip is required
- Chrome vanadium with drop forged jaws, heat treated and nickel plated

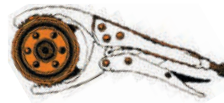

Item ID: 409

## POWER GRIP PLIERS

- Self locking with release lever
- With locking nut on adjustment knob for pre-setting, ideal for repeated use
- Wire cutter and crimper function
- Chrome molybdenum



ITEM ID:	LENGTH		CAPACITY mm	🏋️ g
	Inch	mm		
404-4	4	100	35	180
404-6	6	155	35	197
404-9	9	230	70	380





5 Pieces

**POWER GRIP PLIER SET**

- All the most commonly used power grip pliers in one set
- Self locking with release lever
- With locking nut on adjustment knob for pre-setting, ideal for repeated use
- Wire cutter and crimper function
- Chrome molybdenum

POWER GRIP PLIERS:	
STANDARD ROUND JAW	4" / 100 mm
	7" / 180 mm
	10" / 250 mm
LONG NOSE	4" / 100 mm
	6" / 155 mm

Item ID: **TTVG05**



3 Pieces

**POWER GRIP PLIER SET**

- The most commonly used power grip pliers in one set
- Self locking with release lever
- With locking nut on adjustment knob for pre-setting, ideal for repeated use
- Wire cutter and crimper function
- Chrome molybdenum

POWER GRIP PLIERS:	
STANDARD ROUND JAW	4" / 100 mm
LONG NOSE	4" / 100 mm
	6" / 155 mm

Item ID: **TTZVG03**



2 Pieces

**POWER GRIP PLIER SET**

- The two most commonly used types in one handy set
- Self locking with release lever
- With locking nut on adjustment knob for pre-setting, ideal for repeated use
- Wire cutter and crimper function
- Chrome molybdenum

POWER GRIP PLIERS:	
STANDARD ROUND JAW	10" / 250 mm
LONG NOSE	6" / 155 mm

Item ID: **402**





**C CLAMP POWER GRIP PLIERS**

- Self locking with release lever
- With locking nut on adjustment knob for pre-setting, ideal for repeated use
- Chrome vanadium



ITEM ID:	L mm	L AF	Capacity mm	Throat Depth mm	Throat Height mm	g
406	280	11"	0-80	70	100	772

**C CLAMP POWER GRIP PLIERS**

- Self locking with release lever
- With locking nut on adjustment knob for pre-setting, ideal for repeated use
- Chrome vanadium with nickel plating



ITEM ID:	L mm	L AF	Capacity mm	Throat Depth mm	Throat Height mm	g
406-6	172	6"	0-50	40	60	235

**C CLAMP POWER GRIP PLIERS**

- Non pinch one hand operation for easier use
- Self locking with release lever
- With locking nut on adjustment knob for pre-setting, ideal for repeated use
- Chrome vanadium with nickel plating



ITEM ID:	L mm	L AF	Capacity mm	Throat Depth mm	Throat Height mm	g
406-6S	172	6"	0-50	40	60	235
406S	285	11"	0-80	70	100	760

**C CLAMP POWER GRIP PLIERS**

- Swivel pads for a self levelling grip when clamping
- Self locking with release lever
- With locking nut on adjustment knob for pre-setting, ideal for repeated use
- Chrome vanadium



ITEM ID:	L mm	L AF	Capacity mm	Throat Depth mm	Throat Height mm	g
406P	280	11"	0-80	70	100	772



**C CLAMP POWER GRIP PLIERS**

- Swivel pads for a self levelling grip when clamping
- Self locking with release lever
- With locking nut on adjustment knob for pre-setting, ideal for repeated use
- Chrome vanadium



ITEM ID:	L mm	L AF	Capacity mm	Throat Depth mm	Throat Height mm	 g
406-6P	172	6"	0-50	40	60	235

**C CLAMP POWER GRIP PLIERS**

- Swivel pads for a self levelling grip when clamping
- Non pinch one hand operation for easier use
- Self locking with release lever
- With locking nut on adjustment knob for pre-setting, ideal for repeated use
- Chrome vanadium with nickel plating



ITEM ID:	L mm	L AF	Capacity mm	Throat Depth mm	Throat Height mm	 g
406-6SP	172	6"	0-50	40	60	235
406SP	285	11"	0-80	70	100	760

**C CLAMP POWER GRIP PLIERS**

- Self locking with release lever
- With locking nut on adjustment knob for pre-setting, ideal for repeated use
- Chrome vanadium



ITEM ID:	L mm	L AF	Capacity mm	Throat Depth mm	Throat Height mm	 g
4185	450	18"	0-150	250	130	1192

**C CLAMP POWER GRIP PLIERS**

- Swivel pad for a self levelling grip when clamping
- Self locking with release lever
- With locking nut on adjustment knob for pre-setting, ideal for repeated use
- Chrome vanadium



ITEM ID:	L mm	L AF	Capacity mm	Throat Depth mm	Throat Height mm	 g
4185P	450	18"	0-150	250	130	1192

**WELDING POWER GRIP PLIERS**

- Self locking with release lever
- With locking nut on adjustment knob for pre-setting, ideal for repeated use
- Chrome vanadium



ITEM ID:	L mm	L AF	Capacity mm	 g
407	230	9"	0-65	580

**WELDING POWER GRIP PLIERS**

- Non pinch one hand operation for easier use
- Self locking with release lever
- With locking nut on adjustment knob for pre-setting, ideal for repeated use
- Chrome vanadium with nickel plating



ITEM ID:	L mm	L AF	Gap Width mm	Jaw Depth mm	 g
407AS	270	11"	90	85	855





**SHEET METAL POWER GRIP PLIERS**

- Self locking with release lever
- With locking nut on adjustment knob for pre-setting, ideal for repeated use
- Chrome vanadium



ITEM ID:	L mm	L AF	Capacity mm	g
408	230	8"	0-65	580

**MACHINE TABLE CLAMP LOCKING PLIERS**

- Swivel pad for a self levelling grip when clamping
- Non pinch one hand operation for easier use
- Self locking with release lever
- With locking nut on adjustment knob for pre-setting, ideal for repeated use



ITEM ID:	L mm	Clamping Height mm	Clamp Hole mm	g
410P	320	65	10	580

**CLAMPING POWER GRIP PLIERS**

- Swivel pads for a self levelling grip when clamping
- Non pinch one hand operation for easier use
- Self locking with release lever
- With locking nut on adjustment knob for pre-setting, ideal for repeated use
- Chrome vanadium with nickel plating



ITEM ID:	L mm	L AF	Capacity mm	g
409P	300	12"	0-65	580

**MACHINE TABLE CLAMP LOCKING PLIERS**

- Swivel pad for a self levelling grip when clamping
- Non pinch one hand operation for easier use
- Self locking with release lever
- With locking nut on adjustment knob for pre-setting, ideal for repeated use



ITEM ID:	L mm	Clamping Height mm	Clamp Hole mm	g
410SP	230	65	4	580

**CLAMPING POWER GRIP PLIERS**

- Swivel pads for a self levelling grip when clamping
- Non pinch one hand operation for easier use
- Self locking with release lever
- With locking nut on adjustment knob for pre-setting, ideal for repeated use
- Chrome vanadium with nickel plating



ITEM ID:	L mm	L AF	Gap Width mm	g
409SP	300	12"	88	740





Suzuki Team Sweden



# INSULATED TOOLS

**PROTECT YOURSELF** FROM ELECTRIC SHOCK

All 1000-volt tools from Teng Tools conform to or exceed all specifications that the relevant authorities have established. Each tool is individually tested before it is marked with a special standard tag and a marking that indicates the year of manufacture.

The screwdriver shaft in the 1000 volt range is covered with two layers of insulation in different colours that make it easy to see whether the insulation is damaged. The blades are insulated before the handle is moulded, which makes the screwdrivers safer.



Size and tip marked at the bottom of each handle for easy identification

Hole in the handle can be used in a fall arrest system, for storage and for use as a T-handle

The bi-material handle is designed for increased comfort and smooth action preventing blisters after continuous use. It gives better support and increased power transfer.

Integrated protective insulation with two colours to clearly indicate if there is any damage to the insulation

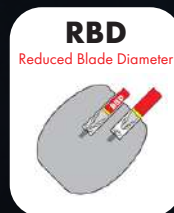

RBD shafts are ultra slim allowing for recessed screws to be accessed easily

TT-MV PLUS steel alloy for greater strength and material flexibility



## What are our insulated tools tested for?

- Insulation properties, i.e. resistance up to 1000 volts in dry or humid environments. ✓
- Resistance to the cold, i.e. how well the tool withstands the cold ✓
- Durability, i.e. that the insulating handles do not come loose ✓
- Resistance to fire, i.e. how well the tool withstands fire ✓
- Insulating properties under pressure, i.e. how well the tool maintains its insulating properties when subjected to pressure ✓



## MANUFACTURED TO THE HIGHEST STANDARD

IEC 60 900 is an international standard for testing tools designed for electrical work on the production line

DIN EN 60900 is a European standard drawn up in 1995 and which states that each individual tool must be tested with regard to insulation for 1000 volts

VDE is an independent authority that tests and checks tools with regard to construction, production and packaging



The cutting capacity is laser marked next to the cutting edge makes it easy to see which pliers you need to choose

Made from chrome molybdenum alloy steel for maximum durability and strength

## TPR GRIP

An ergonomic bi-material handle that is more comfortable in your hand

Extra support when using greater force and a lighter weight

Integrated protective insulation with two colours to clearly indicate if there is any damage to the insulation





### FLAT (SLOTTED) BLADE INSULATED SCREWDRIVERS

- Reduced blade diameter giving an ultra slim blade for easier access
- Integrated protective insulation with two colours to clearly indicate if there is any damage to the insulation
- For use with slotted screws
- TT-MV PLUS steel alloy for greater strength and material flexibility
- Ergonomically designed bi-material handle for easy use with higher torque
- Designed and manufactured to DIN 5264 and IEC60900 (EN60900)

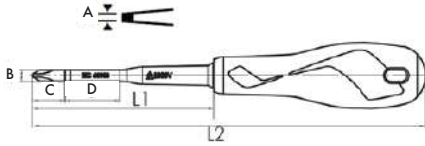

ITEM ID:	a mm	b mm	c mm	d mm	⌀	L1 mm	L2 mm	g	⚡
MDV724N	0.8	4	15	31.5	RBD	101	210	51	M
MDV726N	1	5.5	15	31.5	RBD	127	235	66	M

### PH BLADE INSULATED SCREWDRIVERS

- Reduced blade diameter giving an ultra slim blade for easier access
- Approved for live working up to 1,000 volts
- Integrated protective insulation with two colours to clearly indicate if there is any damage to the insulation
- For use with Phillips type screws
- TT-MV PLUS steel alloy for greater strength and material flexibility
- Ergonomically designed bi-material handle for easy use with higher torque
- Designed and manufactured to DIN ISO 8764 and IEC60900 (EN60900)

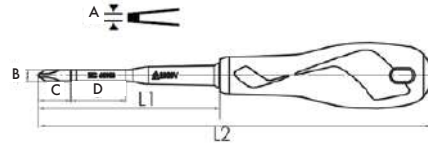

ITEM ID:	⊕	b mm	c mm	d mm	⌀	L1 mm	L2 mm	g	⚡
MDV742N	PH1	4.5	18	30	RBD	81	190	51	M
MDV744N	PH2	6	18	30.5	RBD	100	217	95	L

### FLAT (SLOTTED) BLADE INSULATED SCREWDRIVERS

- Approved for live working up to 1,000 volts
- Integrated protective insulation with two colours to clearly indicate if there is any damage to the insulation
- For use with slotted screws
- TT-MV PLUS steel alloy for greater strength and material flexibility
- Ergonomically designed bi-material handle for easy use with higher torque
- Designed and manufactured to DIN 5264 and IEC60900 (EN60900)

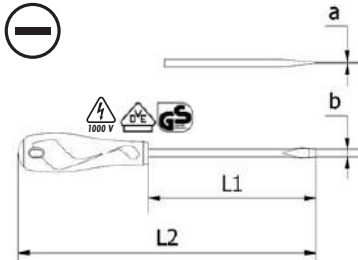

ITEM ID:	a mm	b mm	⌀	L1 mm	L2 mm	g	⚡
MDV820N	0.4	2.5	insulated	75	171	49	S
MDV822N	0.5	3	insulated	100	196	56	S
MDV823N	0.6	3.5	insulated	100	196	58	S
MDV824N	0.8	4	insulated	100	208	60	M
MDV826N	1	5.5	insulated	125	233	89	M
MDV828N	1.2	6.5	insulated	150	266	135	L

### PH BLADE INSULATED SCREWDRIVERS

- Approved for live working up to 1,000 volts
- Integrated protective insulation with two colours to clearly indicate if there is any damage to the insulation
- For use with Phillips type screws
- TT-MV PLUS steel alloy for greater strength and material flexibility
- Ergonomically designed bi-material handle for easy use with higher torque
- Designed and manufactured to DIN ISO 8764 and IEC60900 (EN60900)

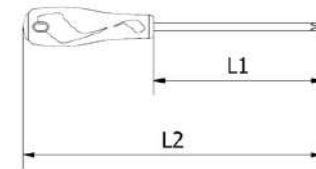

ITEM ID:	⊕	⌀	L1 mm	L2 mm	g	⚡
MDV840N	PH0	insulated	60	156	49	S
MDV842N	PH1	insulated	80	188	54	M
MDV844N	PH2	insulated	100	216	118	L
MDV846N	PH3	insulated	150	275	177	XL

**PZ BLADE INSULATED SCREWDRIVERS**

- Reduced blade diameter giving an ultra slim blade for easier access
- Approved for live working up to 1,000 volts
- Integrated protective insulation with two colours to clearly indicate if there is any damage to the insulation
- For use with Pozidriv type screws
- TT-MV PLUS steel alloy for greater strength and material flexibility
- Ergonomically designed bi-material handle for easy use with higher torque
- Designed and manufactured to DIN ISO 8764 and IEC60900 (EN60900)

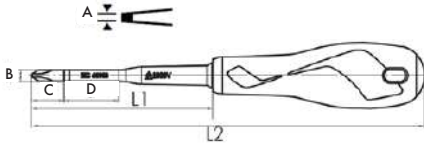

ITEM ID:		b mm	c mm	d mm		L1 mm	L2 mm		
MDV762N	PZ1	4.5	18	30	RBD	81	190	51	M
MDV764N	PZ2	6	18	30.5	RBD	100	217	95	L

**PLUS/MINUS BLADE INSULATED SCREWDRIVERS**

- Approved for live working up to 1,000 volts
- Integrated protective insulation with two colours to clearly indicate if there is any damage to the insulation
- TT-MV PLUS steel alloy for greater strength and material flexibility
- Ergonomically designed bi-material handle for easy use with higher torque
- Designed and manufactured to IEC60900 (EN60900)

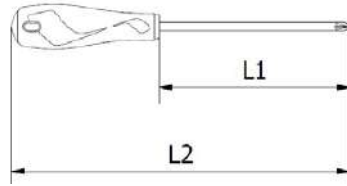

ITEM ID:			L1 mm	L2 mm		
MDV844NF	Slotted/PH2	insulated	100	216	118	L
MDV864NF	Slotted/PZ2	insulated	100	216	118	L

**PZ BLADE INSULATED SCREWDRIVERS**

- Approved for live working up to 1,000 volts
- Integrated protective insulation with two colours to clearly indicate if there is any damage to the insulation
- For use with Pozidriv type screws
- TT-MV PLUS steel alloy for greater strength and material flexibility
- Ergonomically designed bi-material handle for easy use with higher torque
- Designed and manufactured to DIN ISO 8764 and IEC60900 (EN60900)

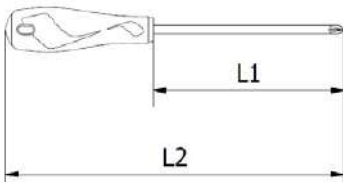

ITEM ID:			L1 mm	L2 mm		
MDV860N	PZ0	insulated	60	156	49	S
MDV862N	PZ1	insulated	80	188	54	M
MDV864N	PZ2	insulated	100	216	118	L
MDV866N	PZ3	insulated	150	275	177	XL

**ROB BLADE INSULATED SCREWDRIVER**

- Approved for live working up to 1,000 volts
- Integrated protective insulation with two colours to clearly indicate if there is any damage to the insulation
- For use with ROB type screws with a square hole
- TT-MV PLUS steel alloy for greater strength and material flexibility
- Ergonomically designed bi-material handle for easy use with higher torque
- Designed and manufactured to IEC60900 (EN60900)

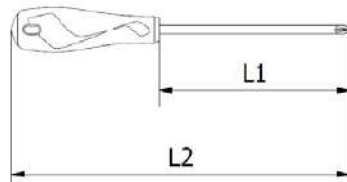

ITEM ID:			L1 mm	L2 mm		
MDV802N	ROB2	insulated	100	216	118	L



Insulated according to IEC 60900, usable up to 1000 V

VDE tested, also in conformance to GPSG (Equipment and Product Safety Act)

Reduced blade diameter (RBD)

Shaft Type    Handle Type    Weight



### NEW HANDLE FOR INTERCHANGEABLE BLADES

- Approved for live working up to 1,000 volts
- Integrated protective insulation with two colours to clearly indicate if there is any damage to the insulation
- For use 1000V interchangeable blades
- Ergonomically designed bi-material handle for easy use with higher torque
- Designed and manufactured to IEC60900 (EN60900)



ITEM ID:	Length mm	Height mm	Width mm	g	Handle Type
MDV700	122	36.7	37	66 g	L

### NEW HANDLE FOR INTERCHANGEABLE BLADES

- Approved for live working up to 1,000 volts
- Integrated protective insulation with two colours to clearly indicate if there is any damage to the insulation
- For use 1000V interchangeable blades
- Ergonomically designed bi-material handle for easy use with higher torque
- Designed and manufactured to IEC60900 (EN60900)



ITEM ID:	Length mm	Height mm	Width mm	g	Handle Type
MDV710	100	23	23	26g	S

### NEW INTERCHANGEABLE BLADES

- Approved for live working up to 1,000 volts
- Integrated protective insulation with two colours to clearly indicate if there is any damage to the insulation
- For use with 1000V handles
- Designed and manufactured to IEC60900 (EN60900)



ITEM ID:	Tip	Shaft Type	Length mm	Height mm	Width mm	g
MDV731	3	insulated	111	13	13	9 g
MDV732	4	RBD	151	13	13	15 g
MDV733	5.5	RBD	131	13	13	21 g
MDV734	6.5	RBD	151	13	13	28 g
MDV751	PH1	RBD	131	13	13	15 g
MDV752	PH2	RBD	151	13	13	26 g
MDV771	PZ1	RBD	131	13	13	15 g
MDV772	PZ2	RBD	151	13	13	26 g

### NEW



Get organised!	
Tray Size	
TT	



### INSULATED SCREWDRIVER SET

- Interchangeable blades for a wide range of tips in one set
- Approved for live working up to 1,000 volts
- Integrated protective insulation with two colours to clearly indicate if there is any damage
- Designed and manufactured to DIN5264, DIN ISO 8764 and IEC60900 (EN60900)

Insulated handles: 22x100mm, 37x122mm			
1000V Insulated Screwdriver blades:			
3 mm	Reg mm:	3 x 70	
4 mm	Slim mm:	4 x 100	5.5 x 80 6.5 x 100
PH1	mm:	PH1 x 80	PH2 x 100
PZ1	mm:	PZ1 x 80	PZ2 x 100

Item ID: TTV710N

1000V



Insulated according to IEC 60900, usable up to 1000 V  
 VDE tested, also in conformance to GPSG (Equipment and Product Safety Act)  
 Reduced blade diameter (RBD)  
 Shaft Type    Handle Type    Weight





Get organised!



Tray Size

TT			
----	--	--	--



**INSULATED SCREWDRIVER SET**

- Approved for live working up to 1,000 volts
- Integrated protective insulation with two colours to clearly indicate if there is any damage
- Designed and manufactured to DIN5264, DIN ISO 8764-1 and IEC60900 (EN60900)

1000V Insulated Screwdrivers:			
	mm:	4 x 100	5.5 x 125
	mm:	PH1 x 80	PH2 x 100
	mm:	PZ1 x 80	PZ2 x 100

Item ID: **TTV706N**



Get organised!



Tray Size

TT			
----	--	--	--



**INSULATED SCREWDRIVER SET**

- Approved for live working up to 1,000 volts
- Integrated protective insulation with two colours to clearly indicate if there is any damage
- Designed and manufactured to DIN5264, DIN ISO 8764 and IEC60900 (EN60900)

1000V Insulated Screwdrivers:				
	mm:	2.5 x 75	4 x 100	5.5 x 125
	mm:	PH0 x 60	PH1 x 80	PH2 x 100
	mm:	PZ2 x 100		

Item ID: **TTV907N**



Get organised!



Tray Size

TTD			
-----	--	--	--



**INSULATED SCREWDRIVER SET**

- Approved for live working up to 1,000 volts
- Integrated protective insulation with two colours to clearly indicate if there is any damage
- Designed and manufactured to DIN5264, DIN ISO 8764 and IEC60900 (EN60900)

1000V Insulated Screwdrivers:					
	mm:	2.5 x 75	3 x 100	4 x 100	5.5 x 125
	mm:	PH0 x 60	PH1 x 80	PH2 x 100	
	mm:	PZ0 x 60	PZ1 x 80	PZ2 x 100	

Item ID: **TTDV910N**



Get organised!



Tray Size

TED			
-----	--	--	--



**INSULATED SCREWDRIVER SET**

- Approved for live working up to 1,000 volts
- Integrated protective insulation with two colours to clearly indicate if there is any damage
- A 100-250 volt tester is also included for checking circuits
- Tools are held in place using three colour pre-cut EVA foam
- Designed and manufactured to DIN ISO 8764, DIN5264 and IEC60900 (EN60900)

100-250V Voltage Tester					
1000V Insulated Screwdrivers:					
	mm:	2.5 x 75	3 x 100	4 x 100	5.5 x 125
	mm:	PH0 x 60	PH1 x 80	PH2 x 100	
	mm:	PZ2 x 100			

Item ID: **TEDV909N**



## INSULATED SCREWDRIVER SET

- Approved for live working up to 1,000 volts
- Protective insulation with two colours to clearly indicate if there is any damage to the insulation
- Supplied with a wall rack for fixing to the wall or a workbench
- Designed and manufactured to DIN5264, DIN ISO 8764 and IEC60900 (EN60900)

1000V Insulated Screwdrivers:		
⊖ mm:	3 x 100	5.5 x 125
⊕ mm:	PH1 x 80	PH2 x 100
⊕ mm:	PZ2 x 100	

Item ID: **WRMDV05N**



## INSULATED SCREWDRIVER SET

- Approved for live working up to 1,000 volts
- Protective insulation with two colours to clearly indicate if there is any damage to the insulation
- Supplied with a wall rack for fixing to the wall or a workbench
- Designed and manufactured to DIN5264, DIN ISO 8764 and IEC60900 (EN60900)

100 - 250V Voltage Tester				
1000V Insulated Screwdrivers:				
⊖ mm:	2.5 x 75	3 x 100	4 x 100	5.5 x 125
⊕ mm:	PH1 x 80	PH2 x 100		

Item ID: **WRMDV07N**



## INSULATED SCREWDRIVER SET

- Approved for live working up to 1,000 volts
- Integrated protective insulation with two colours to clearly indicate if there is any damage to the insulation
- Designed and manufactured to DIN5264, DIN ISO 8764 and IEC60900 (EN60900)

1000V Insulated Screwdrivers:				
⊖ mm:	2.5 x 75	3 x 100	4 x 100	5.5 x 125
⊕ mm:	PH1 x 80	PH2 x 100		

Item ID: **MDV906N**

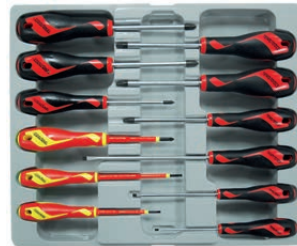

## SCREWDRIVER SET

- TT-MV PLUS steel alloy for greater strength and material flexibility
- Ergonomically designed bi-material handle for easy use with higher torque and faster speed
- Hole in the handle for hanging or for use as a T handle for extra torque or with a fall protection wire if needed
- The handle is moulded around the blade to ensure straightness and to allow larger blade wings which give a higher torque capacity
- Supplied in a full colour display box with PS tray

Screwdrivers:			
⊖ mm:	2.5 x 75	3.5 x 100	5.5 x 150
⊖ mm:	2.5 x 75	3.0 x 100	
⊕ mm:	PH1 x 75	PH1 x 80	
⊕ mm:	PH2 x 100		
⊕ mm:	PZ2 x 100		
⊕ mm:	TX20 x 100	TX25 x 100	TX30 x 100

Item ID: **MD912N1**



## CUTTING CAPACITY FOR PLIERS

The cutting capacity is laser marked next to the cutting edge of Teng Tools pliers which makes it easier to see which pliers you need to choose at a glance.



Piano Wire

Hard Wire

Medium Hard Wire

### HEAVY DUTY INSULATED SIDE CUTTING PLIER

- Approved for live working up to 1,000 volts
- Integrated protective insulation with two colours to clearly indicate if there is any damage to the insulation
- Chrome molybdenum steel
- 80° cutting edge angle
- High leverage function for increased cutting capacity
- TPR grip for a more secure and comfortable grip
- Designed and manufactured to DIN5749 and IEC60900 (EN60900)



ITEM ID:	LENGTH		GRIP	CUTTING CAPACITY mm			g
	Inch	mm					
MBV442-8	8"	200	TPR	2.5	3.0	4.0	305

### INSULATED SIDE CUTTING PLIER

- Approved for live working up to 1,000 volts
- Integrated protective insulation with two colours to clearly indicate if there is any damage to the insulation
- Chrome molybdenum steel
- 80° cutting edge angle
- Electricians style function
- TPR grip for a more secure and comfortable grip
- Designed and manufactured to DIN5749 and IEC60900 (EN60900)



ITEM ID:	LENGTH		GRIP	CUTTING CAPACITY mm			g
	Inch	mm					
MBV441-6	6"	150	TPR	1.6	2.0	2.5	206

### INSULATED COMBINATION PLIERS

- Approved for live working up to 1,000 volts
- Integrated protective insulation with two colours to clearly indicate if there is any damage to the insulation
- Features a pipe grip with serrated jaw for a more secure grip
- Chrome molybdenum alloy steel for durability and strength
- 80° cutting edge angle
- TPR grip for a more secure and comfortable grip
- Designed and manufactured to DIN5746 and IEC60900 (EN60900)



ITEM ID:	LENGTH		GRIP	CUTTING CAPACITY mm			g
	Inch	mm					
MBV451-7	7"	175	TPR	1.8	2.0	3.8	225
MBV451-8	8"	200	TPR	2.0	2.2	4.0	283





### INSULATED LONG NOSE PLIERS

- Approved for live working up to 1,000 volts
- Integrated protective insulation with two colours to clearly indicate if there is any damage to the insulation
- Long straight jaws for easier access
- Jaws with a serrated grip for increased gripping power
- Chrome molybdenum alloy steel for durability and strength
- 80° cutting edge angle
- TPR grip for a more secure and comfortable grip
- Designed and manufactured to DIN5745 and IEC60900 (EN60900)



**TPR**



ITEM ID:	LENGTH		GRIP	CUTTING CAPACITY mm			g
	Inch	mm		●	◐	◑	
MBV461-8	8"	200	TPR	1.5	1.8	2.8	199

### INSULATED WIRE STRIPPING PLIERS

- Approved for live working up to 1,000 volts
- Integrated protective insulation with two colours to clearly indicate if there is any damage to the insulation
- Medium carbon alloy steel construction
- With adjuster screw to suit wire diameters from 0.2 to 4.5mm
- Return spring for easier operation
- TPR grip for a more secure and comfortable grip
- Designed and manufactured to IEC60900 (EN60900)



**TPR**



ITEM ID:	LENGTH		GRIP	STRIPPING CAPACITY mm	g
	Inch	mm		●	
MBV499-7	6"	155	TPR	0.2 - 4.5	175



### INSULATED PLIER SET



- Approved for live working up to 1,000 volts
- Integrated protective insulation with two colours to clearly indicate if there is any damage
- TPR grip for a more secure and comfortable grip
- Designed and manufactured to DIN5745, DIN5746, DIN5749 and IEC60900 (EN60900)

1000V Insulated Pliers:	
SIDE CUTTER	6" / 150 mm
LONG NOSE	8" / 200 mm
COMBINATION PLIERS	7" / 175 mm
WIRE STRIPPING PLIERS	6" / 155 mm

Item ID: TTV440



### INSULATED PLIER SET



- Approved for live working up to 1,000 volts
- Integrated protective insulation with two colours to clearly indicate if there is any damage
- TPR grip for a more secure and comfortable grip
- Tools are held in place using three colour pre-cut EVA foam
- Designed and manufactured to DIN5745, DIN5746, DIN5749 and IEC60900 (EN60900)

1000V Insulated Pliers:	
SIDE CUTTER	6" / 150 mm
LONG NOSE	8" / 200 mm
COMBINATION PLIERS	8" / 200 mm
WIRE STRIPPING PLIERS	6" / 155 mm

Item ID: TEDV440





**INSULATED PLIER SET**



- Approved for live working up to 1,000 volts
- Protective insulation with two colours to clearly indicate if there is any damage to the insulation
- TPR grip for a more secure and comfortable grip
- Supplied with a wall rack for fixing to the wall or a workbench
- Designed and manufactured to DIN5745, DIN5746, DIN5749 and IEC60900 (EN60900)



1000V Insulated Pliers:	
SIDE CUTTER	6" / 150 mm
HEAVY DUTY SIDE CUTTERS	8" / 200 mm
LONG NOSE	8" / 200 mm
COMBINATION PLIERS	7" / 175 mm

Item ID: **WRMBV04**



**INSULATED SCREWDRIVER AND PLIER SET**

- Approved for live working up to 1,000 volts
- Integrated protective insulation with two colours to clearly indicate if there is any damage to the insulation
- TPR grip on the pliers and bi-material handles on the screwdrivers for a more secure and comfortable grip
- Hard wearing case with tools laid out to easily identify where tools belong
- Secure lock system to ensure that the lid is closed correctly
- Designed and manufactured to DIN and ISO standards

1000V Screwdrivers:						
	mm:	2.5 x 75	3 x 100	4 x 100	5.5 x 125	6.5 x 150
	mm:	PH0 x 60	PH1 x 80	PH2 x 100	PH3 x 150	
	mm:	PZ0 x 60	PZ1 x 80	PZ2 x 100	PZ3 x 150	
1000V Pliers:						
6" side cutters, 8" heavy duty side cutters, 8" combination, 8" long nose, 7" wire strippers						

Item ID: **TV18N**



**What are our insulated tools tested for?**

- Insulation properties, i.e. resistance up to 1000 volts in dry or humid environments.
- Resistance to the cold, i.e. how well the tool withstands the cold
- Durability, i.e. that the insulating handles do not come loose
- Resistance to fire, i.e. how well the tool withstands fire
- Insulating properties under pressure, i.e. how well the tool maintains its insulating properties when subjected to pressure

1000V





# CUTTING TOOLS

**ACCURACY & EFFICIENCY** AS STANDARD

Selecting the right cutting tool for the correct application is vital to complete the task safely and efficiently. From snap off blade knives to tin snips and hacksaws to tap & die sets we have the tools you will need here.



Chrome molybdenum alloy steel drop forged cutting blades for extra strength

Cuts up to 1.5mm cold rolled steel or 0.9mm stainless steel

Spring loaded high leverage handles for increased cutting capacity

Double spring with high torsional strength for frequent use



Safety lock for safe storage

Bi-material grip for more comfortable use

Features an automatic blade return mechanism

Replacement blade automatically inserted from the internal storage section

Bi-material plastic handle for a more comfortable grip

Non-slip grip area for a more secure grip





### STRAIGHT CUT TIN SNIPS

- Chrome molybdenum alloy steel drop forged cutting blades
- Cuts up to 1.5mm steel or 0.9mm stainless steel
- Spring loaded high leverage handles for increased cutting capacity
- Safety lock for safe storage
- Bi-material grip for more comfortable use



ITEM ID:	Length	Type	Handle	Steel mm	Stainless Steel mm
490	10"	Straight	Yellow	1.5	0.9

### OFF SET STRAIGHT/RIGHT TIN SNIPS

- Cuts up to 1.5mm steel or 0.9mm stainless steel
- Blade angle designed to cut towards the right when cutting curves
- Also cuts in a straight line
- Bi-material grip for more comfortable use



ITEM ID:	Length	Type	Steel mm	Stainless Steel mm
493	10"	Off set/Right	1.5	0.9

### STRAIGHT/RIGHT CUT TIN SNIPS

- Chrome molybdenum alloy steel drop forged cutting blades
- Cuts up to 1.5mm steel or 0.9mm stainless steel
- Blade angle designed to cut towards the right when cutting curves
- Also cuts in a straight line
- Spring loaded high leverage handles for increased cutting capacity
- Safety lock for safe storage
- Bi-material grip for more comfortable use



ITEM ID:	Length	Type	Handle	Steel mm	Stainless Steel mm
491	10"	Straight/Right	Grey	1.5	0.9

### OFF SET STRAIGHT/LEFT TIN SNIPS

- Cuts up to 1.5mm steel or 0.9mm stainless steel
- Blade angle designed to cut towards the right when cutting curves
- Also cuts in a straight line
- Bi-material grip for more comfortable use



ITEM ID:	Length	Type	Steel mm	Stainless Steel mm
494	10"	Off set/Left	1.5	0.9

### STRAIGHT/LEFT CUT TIN SNIPS

- Chrome molybdenum alloy steel drop forged cutting blades
- Cuts up to 1.5mm steel or 0.9mm stainless steel
- Blade angle designed to cut towards the left when cutting curves
- Also cuts in a straight line
- Spring loaded high leverage handles for increased cutting capacity
- Safety lock for safe storage
- Bi-material grip for more comfortable use



ITEM ID:	Length	Type	Handle	Steel mm	Stainless Steel mm
492	10"	Straight/Left	Red	1.5	0.9

### LONG BLADE STRAIGHT CUT TIN SNIPS

- Chrome molybdenum alloy steel drop forged cutting blades
- Cuts up to 0.9mm cold rolled steel or 0.53mm stainless steel
- Spring loaded high leverage handles for increased cutting capacity
- Safety lock for safe storage
- Bi-material grip for more comfortable use



ITEM ID:	Length	Type	Steel mm	Stainless Steel mm
495	11"	Straight/Long cut	0.9/0.94	0.53

**HIGH LEVERAGE STRAIGHT CUT TIN SNIPS**

- Chrome molybdenum alloy steel drop forged cutting blades
- Cuts up to 1.5mm cold rolled steel or 0.9mm stainless steel
- Spring loaded high leverage handles for increased cutting capacity
- Double spring with high torsional strength for frequent use
- Safety lock for safe storage
- Bi-material grip for more comfortable use



ITEM ID:	Length	Type	Copper mm	Steel mm	Hard Steel mm	Stainless Steel mm
490W	10"	Straight	1.8	1.5	1	0.9

**HIGH LEVERAGE RIGHT/STRAIGHT CUT TIN SNIPS**

- Chrome molybdenum alloy steel drop forged cutting blades
- Cuts up to 1.5mm cold rolled steel or 0.9mm stainless steel
- Blade angle designed to cut towards the right when cutting curves
- Also cuts in a straight line
- Spring loaded high leverage handles for increased cutting capacity
- Double spring with high torsional strength for frequent use
- Safety lock for safe storage
- Bi-material grip for more comfortable use



ITEM ID:	Length	Type	Copper mm	Steel mm	Hard Steel mm	Stainless Steel mm
491W	10"	Straight/Right	1.8	1.5	1	0.9

**HIGH LEVERAGE LEFT/STRAIGHT CUT TIN SNIPS**

- Chrome molybdenum alloy steel drop forged cutting blades
- Cuts up to 1.5mm cold rolled steel or 0.9mm stainless steel
- Blade angle designed to cut towards the left when cutting curves
- Also cuts in a straight line
- Spring loaded high leverage handles for increased cutting capacity
- Double spring with high torsional strength for frequent use
- Safety lock for safe storage
- Bi-material grip for more comfortable use



ITEM ID:	Length	Type	Copper mm	Steel mm	Hard Steel mm	Stainless Steel mm
492W	10"	Straight/Left	1.8	1.5	1	0.9

**SCISSORS**

- High carbon stainless steel blades for accurate cutting
- Cutting capacity of 22mm in soft materials
- Bi-material grip for added comfort



ITEM ID:	Length mm	Blade Length mm	Capacity mm
497	138	42	22

**INTRICATE CUTTING SCISSORS**

- Straight cutting jaws
- Sharp cutting edge
- Special grade stainless steel
- Hot drop forged for strength
- Matt finish



ITEM ID:	Length mm	Blade Type	g
SR1160	160	straight, sharp	61

**INTRICATE CUTTING SCISSORS**

- Straight cutting jaws
- Sharp cutting edge
- Special grade stainless steel
- Hot drop forged for strength
- Matt finish



ITEM ID:	Length mm	Blade Type	g
SR1180	180	straight, sharp	77





### INTRICATE CUTTING SCISSORS

- Straight cutting jaws
- Blunt cutting edge
- Special grade stainless steel
- Hot drop forged for strength
- Matt finish

ITEM ID:	Length mm	Blade Type	g
SR2180	180	straight, blunt	69



### INTRICATE CUTTING SCISSORS

- Curved cutting jaws
- Sharp cutting edge
- Special grade stainless steel
- Hot drop forged for strength
- Matt finish

ITEM ID:	Length mm	Blade Type	g
SR3160	160	curved, sharp	61



Get organised!	
Tray Size	TTD

### CUTTING TOOL SET

- Includes high leverage tin snips for straight, left and right cutting
- Utility knife with retractable blade and ergonomic grip
- High carbon stainless steel blade industrial scissors
- Heavy duty cable cutters with compound leverage for easier cutting

Cutting Tools:
Tin snips (straight/left & straight/right), utility knife, scissors, heavy duty cable cutters

Item ID: TTDCT05

5 Pieces

### PROFESSIONAL QUALITY HACKSAW

- Ergonomically designed aluminium handle
- Soft rubber grip area on the handle and frame for a better grip
- 12" Swedish steel M2 HSS 24 TPI blade for consistent quality
- Includes facility for presetting at a 45° or 90° cutting angles

ITEM ID:	Description
701N1	Hacksaw frame
702	2 spare 24 teeth blades



### PROFESSIONAL QUALITY HACKSAW

- Ergonomically designed curved aluminium handle
- Soft rubber grip area on the handle and frame for a better grip
- 12" Swedish steel M2 HSS 24 TPI blade for consistent quality
- Includes facility for presetting at a 45° or 90° cutting angles

ITEM ID:	Description
701N	Hacksaw frame
702	2 spare 24 teeth blades



### PROFESSIONAL QUALITY HACKSAW

- Ergonomically designed aluminium handle for a better grip
- 12" Swedish steel M2 HSS 24 TPI blade for consistent quality
- Includes facility for presetting at a 45° or 90° cutting angles
- Key hole saw facility for cutting in to holes
- Includes storage space for extra blades in the handle

ITEM ID:	Description
701	Hacksaw frame
702	2 spare 24 teeth blades





**MINI HACKSAW**

- 6 blade positions for cutting up, down or sideways
- Supplied with 3 TengTools 6" mini hacksaw blades



ITEM ID:	Description
705	Mini hacksaw frame
705-5	5 spare blades

**MINI HACKSAW**

- Cast aluminium strong frame construction
- Ergonomic rubber grip on the handle for more comfortable use
- Suitable for use with 16 and 24 TPI blades for cutting metal or wood
- One of each blade included



ITEM ID:	Description
705A	Mini hacksaw frame
705A-5	16 teeth blade for wood
705-5	5 spare blades

**HACKSAW BLADE HOLDER**

- Plastic with a non slip handle
- Suitable for use with any standard 12" hacksaw blades
- Supplied with a TengTools 12" hacksaw blade
- Ideal for use as a key hole saw



Item ID: 704

**GUN SAW SET**

- Ergonomically designed pistol style grip
- 4 blade positions for cutting up, down or sideways
- Supplied with a 24 TPI blade for cutting metal
- Supplied with a 10 TPI blade for cutting wood, plastics, etc.



ITEM ID:	Description
703	Gun saw set
703-10	10 teeth blade for wood/plastic
703-24	24 teeth blade for metal

**HACKSAW & KNIFE SET**

- Professional quality hacksaws for technicians and engineers

**Contents:**

12" Hacksaw  
Junior Hacksaw  
Utility Knife

Item ID: 700-PRO5

**HOBBY KNIFE WITH 9MM BLADE**

- Metal casing with a break off tool for removing blunt blade sections
- Sliding blade holder to retract blade when not in use
- Handy pocket clip

ITEM ID:	Description
710A	Hobby Knife
710A-10	10 spare 9mm blades





### HOBBY KNIFE WITH 9MM BLADE

- Plastic casing with a break off tool for removing blunt blade sections
- Slide incorporates a locking mechanism to lock the blade in place at any position, in or out
- Sliding metal blade holder to retract blade when not in use
- Handy pocket clip



ITEM ID:	Description
710H	Hobby Knife
710A-10	10 spare 9mm blades

### HOBBY KNIFE WITH 18MM BLADE

- Plastic casing with a break off tool for removing blunt blade sections
- Slide locking mechanism to lock the blade in place at any position, in or out
- Sliding metal blade holder to retract blade when not in use
- Handy pocket clip
- Supplied with two 18mm snap off blades



ITEM ID:	Description
710G	Hobby Knife
710F-10	10 spare 18mm blades

### HOBBY KNIFE WITH 9MM BLADE

- Plastic casing with a break off tool for removing blunt blade sections
- Sliding metal blade holder to retract blade when not in use
- Handy pocket clip
- Supplied with 2 spare blades



ITEM ID:	Description
710F	Hobby Knife
710A-10	10 spare 9mm blades

### SPARE BLADES

- Spare 9mm break off blades for TengTools craft knives
- Pack of 100 blades

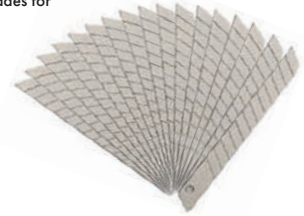

Item ID: 710A-100

### SPARE BLADES

- Spare 18mm break off blades for TengTools craft knives
- Pack of 100 blades

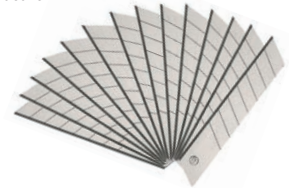

Item ID: 710F-100

### HOBBY KNIFE WITH 18MM BLADE

- Plastic casing with a break off tool for removing blunt blade sections
- Slide locking mechanism to lock the blade in place at any position, in or out
- Sliding metal blade holder to retract blade when not in use
- Handy pocket clip



ITEM ID:	Description
710C	Hobby Knife
710F-10	10 spare 18mm blades



### HOBBY KNIFE SET

- 2 knives with 9mm snap off blades and 2 with 18mm snap off blades

4 Pieces

Snap off blade knives:
9mm blade with metal body
9mm blade with plastic body
18mm blade with plastic body
18mm blade with plastic body and position lock

Item ID: 710S

**FOLDING MINI UTILITY KNIFE**

- Knife folds away in to a pocket knife
- Locking mechanism prevents accidental opening of the knife
- Retractable blade with simple slide action for changing blades



ITEM ID:	Description
P-UKF	Utility knife
710U-10	10 spare blades

**HEAVY DUTY UTILITY KNIFE**

- Ergonomically designed handle with soft non slip grip area
- Retractable 3 step blade for safer use and storage
- Storage for spare blades with quick opening and closing action
- Supplied with 2 spare TengTools blades



ITEM ID:	Description
710N	Utility knife
710-10	10 spare blades

**FOLDING UNIVERSAL UTILITY KNIFE**

- Knife folds away in to a pocket knife
- Locking mechanism prevents accidental opening of the knife
- Retractable blade with simple slide action for changing blades
- Supplied with 3 TengTools utility knife blades



ITEM ID:	Description
712	Utility knife
710-10	10 spare blades

**SAFETY UTILITY KNIFE**

- Bi-material plastic handle for a more comfortable grip
- Non slip grip area for a more secure grip
- Features an automatic blade return mechanism
- Handy release button for quickly and easily ejecting used blades
- Replacement blade automatically inserted from the internal storage section
- Supplied with 6 blades stored in the handle



ITEM ID:	Description
711	Utility knife
710-10	10 spare blades

**HEAVY DUTY UTILITY KNIFE**

- Retractable blade for safer use and storage
- Storage for spare blades with screw lock access
- Supplied with 2 spare TengTools blades



ITEM ID:	Description
710	Utility knife
710-10	10 spare blades

**SPARE BLADES**

- Spare blades for TengTools utility knives
- Pack of 100 blades with storage for used blades

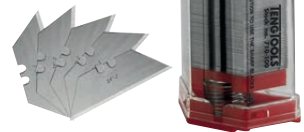

Item ID: 710-100

**SPARE BLADES**

- Spare hook type blades for TengTools utility knives
- Pack of 10 blades with storage for used blades



Item ID: 710-10H



### SPARE BLADES

- Spare hook type blades for TengTools utility knives
- Pack of 100 blades with storage for used blades



Item ID: 710-100H



### UTILITY AND CRAFT KNIFE SET

- Includes a selection of different knives to suit all types of use
- Spare blades included for each type of knife

40 Pieces

#### Knives:

Utility knife with auto load function, folding universal knife, folding mini utility knife, hobby knife with 9mm blade, hobby knife with 18mm blade

#### Spare blades:

5 x Regular knife blades, 10 x Mini knife blades, 10 x 9mm Snap off blades, 10 x 18mm Snap off blades

Item ID: TTK40

### FULLY GROUND DRILL BIT

- Fully ground drill bit
- Standard drill bits for use in steel and cast iron, etc
- Spiral angle of 28° to expel swarf etc
- Point angle of 118° and a split point for better positional accuracy
- Designed and manufactured to DIN338



ITEM ID:	Size mm	Flute Length mm	Overall Length mm	Pack Qty
DBX010	1	12	34	10
DBX015	1.5	18	40	10
DBX020	2	24	49	10
DBX025	2.5	30	57	10
DBX030	3	33	61	10
DBX033	3.3	36	65	10
DBX035	3.5	39	70	10
DBX040	4	43	75	10
DBX042	4.2	43	75	10
DBX045	4.5	47	80	10
DBX050	5	52	86	10
DBX055	5.5	57	93	10
DBX060	6	57	93	10
DBX065	6.5	63	101	10
DBX068	6.8	69	109	10
DBX070	7	69	109	10
DBX075	7.5	69	109	10
DBX080	8	75	117	5
DBX085	8.5	75	117	5
DBX090	9	81	125	5
DBX095	9.5	81	125	5
DBX100	10	87	133	5
DBX105	10.5	87	133	5
DBX110	11	94	142	5
DBX115	11.5	94	142	5
DBX120	12	101	151	5
DBX125	12.5	101	151	5
DBX130	13	101	151	5



**FULLY GROUND DRILL BIT SET**

- Standard drill bits for use with steel and cast iron, etc.
- Spiral angle of 28° for clean cutting
- Split point angle of 118° for better positioning
- Shank the same diameter as the tip
- Designed and manufactured to DIN338

Fully Ground Drill Bits:
1.0 (x3), 1.5 (x3), 2.0 (x2), 2.5 (x2), 3.0, 3.5, 4.0, 4.5, 5.0, 5.5, 6.0, 6.5, 7.0, 7.5, 8.0, 8.5, 9.0, 10.0, 10.5, 11.0, 12.0, 13.0

Item ID: **TTDB28**



**DRILL BIT SET**

- Standard drill bits for use in steel and cast iron, etc
- Spiral angle of 28° to expel swarf etc
- Point angle of 118° and a split point for better positional accuracy
- Designed and manufactured to DIN338

Fully Ground Drill Bits:
1.0(x4), 1.5(x3), 2.0(x2), 2.5, 3.0, 3.3, 3.5, 4.0, 4.2, 4.5, 5.0, 5.5, 6.0, 6.5, 6.8, 7.0, 7.5, 8.0, 8.5, 9.0, 9.5, 10.0

Item ID: **DB028**



**DRILL BIT SET**

- Standard drill bits for use in steel and cast iron, etc
- Spiral angle of 28° to expel swarf etc
- Point angle of 118° and a split point for better positional accuracy
- Designed and manufactured to DIN338

Fully Ground Drill Bits:
1.0(x4), 1.5(x3), 2.0(x2), 2.5, 3.0, 3.3, 3.5, 4.0, 4.2, 4.5, 5.0, 5.5, 6.0, 6.5, 6.8, 7.0, 7.5, 8.0, 8.5, 9.0, 9.5, 10.0, 10.5, 11.0, 11.5, 12.0, 12.5, 13.0

Item ID: **DB034**







### INDIVIDUAL TAPS

- Suitable for repairing damaged threads



ITEM ID:	Size	Description
TDT03050	M3 x 0.5	Spare Tap
TDT04070	M4 x 0.7	Spare Tap
TDT05080	M5 x 0.8	Spare Tap
TDT06100	M6 x 1.0	Spare Tap
TDT08125	M8 x 1.25	Spare Tap
TDT10150	M10 x 1.5	Spare Tap
TDT12175	M12 x 1.75	Spare Tap

### INDIVIDUAL DIES

- Suitable for repairing damaged threads



ITEM ID:	Size	Description
TDD03050	M3 x 0.5	Spare Die
TDD04070	M4 x 0.7	Spare Die
TDD05080	M5 x 0.8	Spare Die
TDD06100	M6 x 1.0	Spare Die
TDD08125	M8 x 1.25	Spare Die
TDD10150	M10 x 1.5	Spare Die
TDD12175	M12 x 1.75	Spare Die

### TAP HANDLE

- Individual tap handle for use with TengTools rethreading taps
- Also suitable for use with TengTools screw extractors (SE05 and TMSE05S)
- Suitable for M3 to M12 tap sizes



Item ID: TAP-HNDL

### DIE HANDLE

- Individual die handle for use with TengTools rethreading dies
- Suitable for M3 to M12 die sizes



Item ID: DIE-HNDL

### ADJUSTABLE TAP CHUCK

- Suitable for use with TengTools taps
- Use with a 1/4" drive ratchet
- Satin finish with a knurled grip for a better grip when handling



ITEM ID:	Drive	For Taps	Chuck Diameter
M140071	1/4"	3-8	20
M140072	1/4"	5-12	25

### TAP CHUCK SERVICE KITS

- Service kit for repairing tap chucks

ITEM ID:	Suitable For
M140071RK	M140071
M140072RK	M140072

### DIE CHUCK

- Suitable for use with TengTools M3 to M12 dies
- Use with a 1/4" drive ratchet
- Satin finish for a better grip when handling



Item ID: M140070



Get organised™  
Tray Size  
TT

17 Pieces

**TAP AND DIE SET**

- Suitable for repairing damaged threads from M3 to M12
- Tap and die holders included
- A thread gauge is included to help identify the pitch of the thread

Metric Dies:
M3 x 0.5, M4 x 0.7, M5 x 0.8, M6 x 1.0, M8 x 1.25, M10 x 1.5, M12 x 1.75
Metric Taps:
M3, M4, M5, M6, M8, M10, M12
Accessories:
Tap handle (capacity M3 to M12), die handle with adjustment screw (capacity M3 to M12), screw pitch gauge

Item ID: **TTTD17**



Get organised™  
Tray Size  
TTD

34 Pieces

**TAP AND DIE SET**

- Designed for the repair of damaged threads covering M3 to M12
- Includes taps and dies with interchangeable chucks
- Screw extractors also included to give a complete set for repairing threads
- Various accessories including drill bits, a screw pitch gauge and mini palm ratchet

Metric Dies:
M3 x 0.5, M4 x 0.7, M5 x 0.8, M6 x 1.0, M8 x 1.25, M10 x 1.5, M12 x 1.75
Metric Taps:
M3, M4, M5, M6, M8, M10, M12
Drill Bits:
2.5mm, 3.3mm, 4.2mm, 5.0mm, 6.8mm, 8.5mm, 10.5mm
Screw Extractors:
1/8", 3/16", 15/64", 5/16", 3/8"
Accessories:
Screw pitch gauge, mini hex screwdriver, 1/4" extension bar, 3/8":1/4"M adaptor, 1/4" mini palm ratchet, 1/4" interchangeable die chuck, 1/4" tap chuck

Item ID: **TTDTD34**





### NEEDLE FILE

- 160mm long with a plastic handle for use with more detailed work
- Hand file type



Item ID: TTNF12-01

### NEEDLE FILE

- 160mm long with a plastic handle for use with more detailed work
- Half round file type



Item ID: TTNF12-02

### NEEDLE FILE

- 160mm long with a plastic handle for use with more detailed work
- Three square triangular file type



Item ID: TTNF12-03

### NEEDLE FILE

- 160mm long with a plastic handle for use with more detailed work
- Square file type



Item ID: TTNF12-04

### NEEDLE FILE

- 160mm long with a plastic handle for use with more detailed work
- Round file type



Item ID: TTNF12-05

### NEEDLE FILE

- 160mm long with a plastic handle for use with more detailed work
- Flat point file type



Item ID: TTNF12-06

### NEEDLE FILE

- 160mm long with a plastic handle for use with more detailed work
- Needle knife file type



Item ID: TTNF12-07

### NEEDLE FILE

- 160mm long with a plastic handle for use with more detailed work
- Barrette file type



Item ID: TTNF12-08

### NEEDLE FILE

- 160mm long with a plastic handle for use with more detailed work
- Crossing file type



Item ID: TTNF12-09

### NEEDLE FILE

- 160mm long with a plastic handle for use with more detailed work
- Oval file type



Item ID: TTNF12-10

### NEEDLE FILE

- 160mm long with a plastic handle for use with more detailed work
- Feather edge file type



Item ID: TTNF12-11

### NEEDLE FILE

- 160mm long with a plastic handle for use with more detailed work
- Round edge file type



Item ID: TTNF12-12





12 Pieces

**NEEDLE FILE SET**

- All the most commonly used types of needle file in one handy set
- Removable lid and dove tail joints

Needle Files:
Hand, half round, three square, square, round, flat point, knife type, barrette, crossing, oval, feather edge, round edge flat

Item ID: TTNF12

**HAND FILE - FLAT**

- 10" hand file
- High carbon steel for durability and strength
- Bi-material handle for a more comfortable grip
- 2nd cut to create a diamond pattern cutting surface for smoother filing
- Cut on both edges for filing grooves, etc



Item ID: FLFT10

**HAND FILE - FLAT**

- 10" hand file
- High carbon steel for durability and strength
- Bi-material handle for a more comfortable grip
- 2nd cut to create a diamond pattern cutting surface for smoother filing
- Cut on both edges for filing grooves, etc



Item ID: FLHF10

**HAND FILE - HALF ROUND**

- 10" hand file
- High carbon steel for durability and strength
- Bi-material handle for a more comfortable grip
- 2nd cut to create a diamond pattern cutting surface for smoother filing



Item ID: FLHR10

**HAND FILE - ROUND**

- 10" hand file
- High carbon steel for durability and strength
- Bi-material handle for a more comfortable grip
- 2nd cut to create a diamond pattern cutting surface for smoother filing



Item ID: FLRD10

**HAND FILE - TRIANGULAR**

- 10" hand file
- High carbon steel for durability and strength
- Bi-material handle for a more comfortable grip
- 2nd cut to create a diamond pattern cutting surface for smoother filing



Item ID: FLTR10





### HAND FILE - SQUARE

- 10" hand file
- High carbon steel for durability and strength
- Bi-material handle for a more comfortable grip
- 2nd cut to create a diamond pattern cutting surface for smoother filing



Item ID: FLSQ10



### HAND FILE SET

- 10" high carbon steel hand files
- Bi-material handle for a more comfortable grip
- 2nd cut to create a diamond pattern cutting surface for smoother filing
- Cut on both edges of the flat files for filing grooves, etc

10" Files:

Flat, Hand, Half Round, Round, Three square

Item ID: TTXF05

5 Pieces



### HAND FILE SET

- 10" high carbon steel hand files
- Bi-material handle for a more comfortable grip
- 2nd cut to create a diamond pattern cutting surface for smoother filing
- Cut on both edges of the flat files for filing grooves, etc
- Supplied with a wall rack for fixing to the wall or a workbench

10" Files:

Flat, Hand, Half Round, Round, Three square

Item ID: WRFL05

5 Pieces





# MEASURING TOOLS

**ACCURACY** IS KEY

Our range of Measuring Tools have been developed by focusing on Teng Tools users requirements across the automotive & industrial sectors. All tools are available individually but are also available in the unique Teng Tools TT trays so you can add them to your existing tool kit or include them when you are building your ultimate tool kit.



Wide range of tools now available including calipers & micrometers

Industrial quality measuring tapes are available in lengths from 3m up to 50m



*All tools developed to exceed the demands of professional users*





### MICROMETER

- Friction thimble and locking nut for easy operation
- Forged frame with hardened steel and polished measuring surfaces
- Matt chrome plated scale for easy reading
- Supplied with a plastic storage case
- Designed and manufactured to DIN863

Specifications:		
Measuring range	mm	0-25
Reading	mm	0.01
Precision	mm	0.004

Item ID: **MIR25**

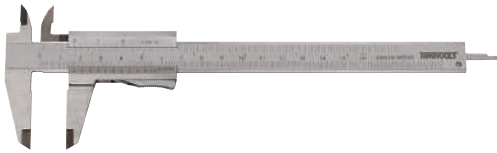

### VERNIER CALIPER

- 4 function caliper to measure height, width, depth and step
- Metric and inch scales with 0.05mm and 1/16" scales
- Frosted chrome plated scale for easier reading
- Stainless steel construction with lapped edges
- Supplied with a plastic storage case
- Designed and manufactured to DIN862

Specifications:		
Length of measurement	mm	150
Jaw length	mm	40

Item ID: **CALV150**



### DIGITAL CALIPER

- 4 function caliper to measure height, width, depth and step
- Adjustable between mm and inches
- Reset button and zero set in any position
- Automatic switch off to conserve batteries
- 0.01 mm reading scale with 8mm high figures
- Uses CR2032 batteries (supplied)
- Supplied with a plastic storage case
- Designed and manufactured to DIN862

Specifications:		
Length of measurement	mm	150
Jaw length	mm	40
Height of figures	mm	8
Resolution	mm	0.01
Accuracy	mm	±0.02

Item ID: **CALD150**

### DIAL INDICATOR WITH MEASURING STAND

- Aluminium dial indicator
- 58mm diameter dial with a turnable scale and two tolerance indexes
- An extra pointer indicates whole millimetres to make measurements simple
- The stand has central locking
- A strong magnet in the base to hold the stand in place when in use



Specifications:		
Measuring range	mm	0-25
Reading	mm	0.01
Maximum height	mm	330
Base plate length	mm	55
Base plate width	mm	50
Base plate height	mm	58
Weight	kg	1.625

Item ID: **DGMM**





### FEELER GAUGES

- Blades for measuring from 0.05mm to 1.0mm
- Hardened rolled steel for durability and accuracy
- Fold up case with tightening screw for easy storage

ITEM ID:	No. of Blades	Blade Length mm
FG13100	13	100
FG20100	20	100
FG20200	20	200



### THREAD GAUGE

- 55 blades in a handy holder with tightening screws
- Suitable for measuring metric and UNC threads
- Manufactured from #45 steel for a long lasting gauge

Metric thread gauges:
0.25, 0.3, 0.35, 0.4, 0.45, 0.5, 0.6, 0.7, 0.75, 0.8, 0.9, 1.0, 1.25, 1.5, 1.75, 2.0, 2.5, 3.0, 3.5, 4.0, 4.5, 5.0, 5.5, 6.0
UNC thread gauges:
4, 4 ½, 5, 5 ½, 6, 7, 8, 9, 10, 11, 11 ½, 12, 13, 14, 15, 16, 18, 20, 22, 24, 26, 27, 28, 30, 32, 34, 36, 38, 40, 42

Item ID: **TGMMUNC**



### STEEL RULES

- Stainless steel to avoid corrosion
- Hanging hole for easy storage

ITEM ID:	Length mm	Width x Thickness mm	Scale
ST150	150	20 x 0.8	mm
ST200	200	20 x 0.8	mm / AF





## BASE SQUARES

- Zinc plated for corrosion resistance
- Base square design enables the square to be sat on a work surface
- Level 3 accuracy

ITEM ID:	Length mm	Blade Length mm
SQAB10070	100	70
SQAB150100	150	100
SQAB200130	200	130
SQAB300175	300	175



## MEASURING TOOL SET

- Ideal for engineers and technicians
- Includes a 4 function vernier caliper, steel rule, scriber and base square

Measuring Tools:		
Vernier caliper	mm/inch	150 / 6"
Steel rule	mm	150
Base square	mm	100 x 70
Scriber TC tipped	mm	150

Item ID: **TTBM**



## MEASURING TOOL SET

- Ideal for mechanics and technicians
- Includes a 4 function digital caliper, multimeter, thread gauge and feeler gauge sets

Measuring Tools:		
Digital caliper	mm/inch	150mm/6"
Thread gauge set	mm/UNC	0.25-6.0mm, 4-42 UNC
Feeler gauge set	mm	100mm blades 0.05 to 1.0mm
Multimeter		AC, DC, voltage, current, resistance, temperature, CAT I 600 volts, CAT II 300 volts,

Item ID: **TTDCM**



## MEASURING TOOL SET

- Ideal for machinists and technicians
- Includes a digital 4 function caliper, micrometer and a dial indicator complete with a magnetic stand
- Tools are held in place using three colour pre-cut EVA foam

Measuring Tools:		
Digital caliper	mm/inch	150 / 6"
Micrometer	mm	0-25
Dial Indicator with stand		0-25mm measuring range
Magnetic stand with central locking		

Item ID: **TEDIMM**

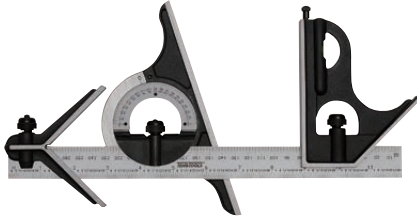

**COMBINATION SQUARE**

- For measuring and checking angles
- Graduated in mm and inches for universal use
- 300mm steel rule with a reversible protractor, adjustable angle ledge and centre head
- Angle ledge and protractor both include a spirit level

Specifications:		
Protractor reading		0-180°
Steel rule length	mm	300
Square head length	mm	110
Centre head length	mm	63

Item ID: **SQAC300**



**ALUMINIUM TRY SQUARES**

- Stainless steel blade with an anodised aluminium stock
- Blade measures 1.5 x 45mm with the stock being 18mm wide
- Milled working surface with deep etched markings
- Highly resistant to wear

ITEM ID:	Blade Length mm	Accuracy	g
SQAA200	200	±0.03	240
SQAA250	250	±0.03	275
SQAA300	100	±0.03	300



**PLASTIC TRY SQUARES**

- Stainless steel blade with a fibre glass framed plastic stock
- Blade measures 1.0 x 45mm with the stock being 18mm wide
- Milled working surface with deep etched markings
- Highly resistant to wear

ITEM ID:	Blade Length mm	Accuracy	g
SQAP250	250	±0.06	150
SQAP300	300	±0.06	160



Check edges for consistency Slide



Duplicates angles For marking

**SLIDING BEVEL**

- Check edges for consistency by sliding the edge over the material
- Duplicate angles for marking by setting the adjustable blade
- Straight and true stainless steel blade for accuracy
- Plastic stock for reduced weight and a better grip

ITEM ID:	Blade Length mm	Width mm	g
AB200	200	25	100





## MEASURING TAPES



- mm and inches for international use
- ABS case for durability
- Rubberised grip for a more secure grip especially when wet or oily
- Tape lock and belt clip for secure storage when being used
- Power return tape for automatic rewinding
- Aligning hook for internal/external measurements
- Designed and manufactured to Cat II

ITEM ID:	Length m	Length ft	Width mm
MT03	3	10	13
MT05	5	16	19
MT08	8	26	25

## MEASURING TAPES



- Graduated in mm only
- ABS case for durability
- Rubberised grip for a more secure grip especially when wet or oily
- Tape lock and belt clip for secure storage when being used
- Power return tape for automatic rewinding
- Aligning hook for internal/external measurements
- Designed and manufactured to Cat II

ITEM ID:	Length m	Width mm
MT03MM	3	13
MT05MM	5	19
MT08MM	8	25

## MEASURING TAPES



- mm and inches for international use
- High impact plastic case for durability
- Rubberised grip for a more secure grip especially when wet or oily
- Tape lock and belt clip for secure storage when being used
- Steel roller cage prevents damage to the case
- Aligning hook for internal/external measurements
- Designed and manufactured to Cat II

ITEM ID:	Length m	Width mm
MT10	10	10
MT15	15	10
MT30	30	10

## MEASURING TAPES



- mm and inches for international use
- High impact plastic case for durability
- Rubberised grip for a more secure grip especially when wet or oily
- Tape lock for secure storage when being used
- Steel roller cage prevents damage to the case when the nylon tape is retracted
- Designed and manufactured to Cat II

ITEM ID:	Length m	Width mm
MTS30	30	12.7
MTS50	50	12.7





**MAGNETIC ALUMINIUM SPIRIT LEVELS**



- Magnetic aluminium "torpedo" spirit level
- 3 magnets on the underside help fix the level to ferrous work pieces
- One horizontal, one vertical and one 45° angled vials
- Crush proof, durable vials with high transparency for easy reading
- Highly resistant to ultra violet light and fluctuations in temperature
- Shock absorbent end protectors to reduce the risk of damage
- Temperature proof vial mountings to reduce the risk of distortion

ITEM ID:	Material	Length mm	Width mm	Height mm	Tolerance Normal	g
SLT01	Aluminium	230	16	38	±1.0mm/m	190
SLT02	ABS Plastic	230	16	40	±1.5mm/m	160



**MAGNETIC ALUMINIUM SPIRIT LEVELS**



- Magnets on the underside help fix the level to ferrous work pieces
- Crush proof, durable vials with high transparency for easy reading
- Highly resistant to ultra violet light and fluctuations in temperature
- Shock absorbent end protectors to reduce the risk of damage
- Temperature proof vial mountings to reduce the risk of distortion

ITEM ID:	Length mm	Width mm	Height mm	Tolerance Normal	Tolerance Inverted	g
SLM0300	300	24	50	±0.75mm/m	±0.75mm/m	240
SLM0400	400	24	50	±0.75mm/m	±0.75mm/m	310
SLM0600	600	24	50	±0.75mm/m	±0.75mm/m	450
SLM1000	1000	24	50	±0.75mm/m	±0.75mm/m	750
SLM1200	1200	24	50	±0.75mm/m	±0.75mm/m	900



**ALUMINIUM SPIRIT LEVEL**



- 400mm long
- One horizontal and two vertical vials (90° and 45°)
- The vials are designed for easy, all round reading
- Impact resistant end caps to reduce the risk of damage
- Measurement accuracy of 1.0mm per meter

Item ID: SLA040



**ALUMINIUM SPIRIT LEVELS**



- Crush proof, durable vials with high transparency for easy reading
- Highly resistant to ultra violet light and fluctuations in temperature
- Shock absorbent end protectors to reduce the risk of damage
- Temperature proof vial mountings to reduce the risk of distortion

ITEM ID:	Length mm	Width mm	Height mm	Tolerance Normal	Tolerance Inverted	g
SLA0300	300	24	50	±0.5mm/m	±0.75mm/m	210
SLA0400	400	24	50	±0.5mm/m	±0.75mm/m	280
SLA0600	600	24	50	±0.5mm/m	±0.75mm/m	420
SLA1000	1000	24	50	±0.5mm/m	±0.75mm/m	690
SLA1200	1200	24	50	±0.5mm/m	±0.75mm/m	840
SLA1500	1500	24	50	±0.5mm/m	±0.75mm/m	1050
SLA1800	1800	24	50	±0.5mm/m	±0.75mm/m	1260
SLA2000	2000	24	50	±0.5mm/m	±0.75mm/m	1400



# AUTO TOOLS

## ESSENTIALS FOR ANY GARAGE

When working on motors and general servicing it is vital that you have the right tools ready when you are. Whether it is a spark plug socket or hose clamps you need tools that are great to work with and bring better results.

Nothing can take the place of hooks & picks when you need one. There are a wide selection of options to choose from.



A range of hose tools are available including hose clip drivers and hose clamps



When working on a vehicle sometimes you need a specific tool for a specific job. See our range of engine tools including spark plug sockets and oil filter removal tools



We offer a range of tools for auto body work including suction lifters and body working hammers

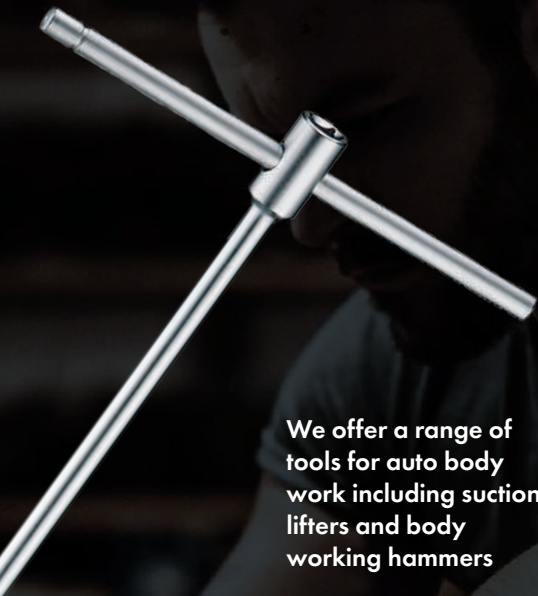



### 90° HOOK TOOL

- Hook tool with a 90° bent hook
- Ideal for retrieving lost or dropped items
- Ergonomically designed bi-material handle for easy use
- Hole in the handle for hanging or for use with a fall protection wire



Item ID: MDH-S

### AWL

- Straight awl with a square tip
- Ideal for piercing materials or for creating a start hole for screws
- Ergonomically designed bi-material handle for easy use
- Hole in the handle for hanging or for use with a fall protection wire



Item ID: MDA-SQ

### S SHAPED HOOK TOOL

- Hook tool with an S shaped bent hook
- Ideal for retrieving lost or dropped items
- Ergonomically designed bi-material handle for easy use
- Hole in the handle for hanging or for use with a fall protection wire



Item ID: MDH-L

### GASKET SCRAPER

- 22mm blade for the easy removal of gasket residue
- Ergonomically designed bi-material handle for easy use
- Hole in the handle for hanging or for use with a fall protection wire



Item ID: MD-SCR

### AWL

- Straight awl with a round tip
- Ideal for piercing materials or for creating a start hole for screws
- Ergonomically designed bi-material handle for easy use
- Hole in the handle for hanging or for use with a fall protection wire



Item ID: MDA-R

### AWL

- Straight awl with a round tip
- Ideal for piercing materials or for creating a start hole for screws
- Ergonomically designed bi-material handle for easy use
- Hole in the handle for hanging or for use with a fall protection wire
- Length: 164mm



Item ID: MDA180





**90° HOOK TOOL**

- Hook tool with a 90° bent hook
- Ideal for retrieving lost or dropped items
- Ergonomically designed bi-material handle for easy use
- Hole in the handle for hanging or for use with a fall protection wire
- Length: 164mm



Item ID: **MDP90**

**35° HOOK TOOL**

- Hook tool with a 35° bent point
- Ideal for retrieving lost or dropped items
- Ergonomically designed bi-material handle for easy use
- Hole in the handle for hanging or for use with a fall protection wire
- Length: 164mm



Item ID: **MDP35**

**125° HOOK TOOL**

- Hook tool with a 125° bent hook
- Ideal for retrieving lost or dropped items
- Ergonomically designed bi-material handle for easy use
- Hole in the handle for hanging or for use with a fall protection wire
- Length: 164mm



Item ID: **MDP125**



**HOOK AND PICK SET**

4 Pieces

- 4 piece hook and pick set
- Includes hooks, awls and picks for detail work and scribing
- Ideal for cleaning components and retrieving lost items in hard to reach places

Hooks & Picks:

Straight Awl, 35° Hook tool, 90° Hook Tool, 125° Hook Tool

Item ID: **TTMDP**



**SCRAPER SET**

4 Pieces

- Includes a gasket scraper, an awl and two hook tools
- Ideal for cleaning, scraping and removing unwanted residue

Scrapers:

Gasket scraper	22mm wide blade, total length 245mm
----------------	-------------------------------------

Hooks & awl	Curved hook, 90° hook and awl
-------------	-------------------------------

Item ID: **TTSR04**





**HOOK AND PICK SET**

4 Pieces

- Interchangeable hooks and picks with an aluminium handle
- The handle has a built in magnet for retrieving lost ferrous parts
- Includes an awl as well as 3 different hooks with 45° and 90° tips
- Supplied in a pocket sized case with a click lock to keep the tools secure

Item ID: **TM149**

**6MM/7MM HOSE CLIP DRIVER**

- Interchangeable double ended socket to give two tools in one
- Fits most commonly used worm drive hose clips
- Flexible shaft for easier access in confined spaces
- Overall length 275mm



ITEM ID:	Description
MD503N	Hose clip driver
MD503RK	Replacement 6/7mm socket

**8MM HOSE CLIP DRIVER**

- Fits European style worm drive hose clips and Jubilee® high torque hose clips
- Flexible shaft for easier access in confined spaces
- Overall length 275mm



Item ID: **MD503ND**

**HOSE CLAMPS**

- Specially designed jaws prevent internal hoses from damage when clamping
- Light weight
- Easy to use
- Non conductive



ITEM ID:	Capacity mm	Capacity AF
AT080	6 to 19	¼" to ¾"
AT085	6 to 32	¼" to 1-¼"
AT090	19 to 57	¾ to 2-¼"

**7MM HOSE CLIP DRIVER**

- Fits most commonly used worm drive hose clips such as Jubilee® hose clips
- Flexible shaft for easier access in confined spaces
- Overall length 275mm



Item ID: **MD503NA**



Get organised!

Item Size
TT

**HOSE CLAMP SET**

3 Pieces

- Range of sizes giving a capacity of 6 to 57mm (¼" to 2 ¼")
- Specially designed jaws prevent internal hoses from damage when clamping
- Lightweight and easy to use
- Non conductive

Hose clamps:
For hoses: 1/4"-3/4", 1/4"-1-1/4", 3/4"-2-1/4"

Item ID: **TTHC03**

**SPARK PLUG BOOT PLIER**

- Designed to pull the spark plug boot from the spark plug without disturbing the HT lead
- Spring action for easier use particularly in confined spaces
- Plastic grip on the handle and the gripping area



ITEM ID:	Length mm	 g
SPBP20	250	297

**SPARK PLUG SOCKETS**

- Chrome vanadium
- Rubber insert holds the spark plug in place to prevent it dropping
- Satin finish for a better grip when handling the socket
- 6 point single hexagon socket for a better grip
- Ball bearing recess on the female end to grip the ratchet
- Supplied with a metal socket clip for use with a socket rail



ITEM ID:	Drive	Size	Width mm	Length mm	Thread Size	 g
M380039-C	3/8"	14mm	20	64	8	73
M380040-C	3/8"	16mm	21.4	64	10	100
M380041-C	3/8"	16mm Flexible	22	85	10	117
M380042-C	3/8"	18mm	23.5	70	12	130
M380046-C	3/8"	21mm	28	70	14	160
M380047-C	3/8"	21mm Flexible	28	91	14	169
M120040-C	1/2"	16mm	21.4	70	10	165
M120042-C	1/2"	18mm	24.2	70	12	165
M120046-C	1/2"	21mm	28	70	14	165



Get organised™  
Tray Size  
**17X**

**SPARK PLUG SOCKET SET**

**3/8"** DRIVE **5** Pieces **mm**

- Spark plug socket set
- 3/8" drive extra long swivelling spark plug sockets for use in hard to reach places
- T bar with the TengTools T-HD handle for more comfortable use

2 Piece T-bar handle						
3/8" Drive extra long swivelling spark plug sockets:						
	mm:	14	16	21		

Item ID: **TTXTB05**



Get organised™  
Tray Size  
**17X**

**3/8"** DRIVE **5** Pieces **mm** **EVA**

**SPARK PLUG SOCKET SET**

- Extra long swivelling spark plug sockets for use in hard to reach places
- T bar with the TengTools T-HD handle for more comfortable use

2 Piece T-bar handle						
3/8" Drive extra long swivelling spark plug sockets:						
	mm:	14	16	21		

Item ID: **TEXTB05**

**T-BAR SPARK PLUG SOCKETS**

- Extra long swivelling spark plug socket
- Long reach bar ideal for use in hard to reach places
- Universal joint and magnet at the socket
- Includes a T bar for fast pretightening and additional torque

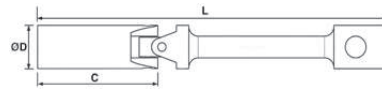

ITEM ID:	Drive	Size mm	D mm	C mm	L mm	 g
TBUSB14	3/8"	14	18.8	60	520	380
TBUSB16	3/8"	16	21.8	60	520	400
TBUSB21	3/8"	21	27.8	60	520	440
T-HD01	200mm x 8mm spare bar for use with T-bar spark plug sockets					

**THREAD CLEANERS**

- Cleaning tool for spark plug threads in engine blocks



ITEM ID:	For Threads mm
TRC1012	10 x 1 & 12 x 1.25
TRC1418	14 x 1.25 & 18 x 1.5



## OIL FILTER REMOVAL TOOL

- Fully adjustable heavy duty strap
- Suitable for workshop tasks where round items need to be gripped
- Strong, drop forged steel handle for high leverage
- Reinforced, rubberised non stretch strap for a good grip
- Grips oil filters, etc up to 160mm diameter
- Overall length 230mm



ITEM ID:	Description
9123	Oil filter wrench
9123RK	Replacement Strap

## OIL FILTER REMOVER PLIER

- 53-118mm capacity to suit most oil filters
- Two stage grip areas on the jaws for added versatility
- Ideal for removing and installing objects of many shapes when a tight grip is required
- Chrome vanadium with drop forged jaws, heat treated and nickel plated



Item ID: 409

## OIL FILTER REMOVAL TOOL

- Nylon webbing strap for gripping oil filters without causing damage
- 1/2" drive carbon steel adaptor for use with a ratchet or flex handle
- Grips oil filters up to 130mm diameter



ITEM ID:	Description	Drive	Capacity mm
9110	Oil filter wrench	1/2"	130
9110RK-1	Replacement Strap		

## OIL FILTER REMOVAL TOOL

- Chain for gripping oil filters even when oily or damaged
- 1/2" drive carbon steel adaptor for use with a ratchet or flex handle
- Grips oil filters up to 120mm diameter



ITEM ID:	Description	Drive	Capacity mm
9120	Oil filter wrench	1/2"	120
9120RK-1	Replacement Chain		

## HEAVY DUTY OIL FILTER REMOVAL TOOL

- Maximum tensile strength of 1,850 kgf for the most stubborn of oil filters
- Chain for gripping oil filters even when oily or damaged
- 1/2" drive adaptor for use with a ratchet or 24mm spanner
- Grips oil filters up to 150mm diameter



Item ID: 9120HD



**OIL SERVICE SET**

- All the tools normally required for an oil service included in one handy set
- Includes an oil filter wrench, drain plug set, spark plug sockets, metric feeler gauge set and a 3 in 1 inspection tool with magnetic pick up

<b>3/8" Drive Accessories:</b>
3" & 10" wobble extensions, 1/2" F x 3/8" Male T-bar adaptor
<b>3/8" Drive Sockets:</b>
21mm regular 6 point socket, 16 & 21mm spark plug sockets
<b>Drain Plug Set:</b>
Bar, 5/16" hex x 3/8" hex, 11mm square x 12mm hex, 17mm hex x 1/2" hex, 8mm square x 3/8" square, 13mm square x 14mm hex, 8mm hex x 10mm hex
<b>Service Tools:</b>
Strap type oil filter wrench, 3 in 1 telescopic inspection tool, 21 piece feeler gauge set (0.005 mm - 1.0 mm)

Item ID: **TTOS16**

**DRAIN PLUG KEYS**

- Double ended design to give 2 tools in 1
- For drain plugs on engines and gear boxes
- Use with a T bar or a 21mm socket or wrench



ITEM ID:	Size
DP0810	8mm hex x 10mm hex
DP0812	8mm square x 3/8" square
DP1012	5/16" hex x 3/8" hex
DP1112	11mm square x 12mm hex
DP1314	13mm square x 14mm hex
DP1716	17mm hex x 1/2" hex

**CYLINDER LEAKAGE TESTER**

- Two in one 14/18mm spark plug hole fitting
- 1/4" BSP female airline coupler for connection to the air supply
- Enables detection of various common engine faults such as worn valves and pistons, blown head gaskets, etc



Item ID: **AT005**

**PISTON RING COMPRESSOR**

- Designed for holding piston rings in place when removing or replacing pistons
- 4 tightening bands suitable for cylinder diameters from 90 to 175mm
- Self locking ratchet pawl prevents premature release and allows a positive locking action
- Friction proof band edge gives a smooth and accurate action



Item ID: **AT020**

**ENGINE CYLINDER HONING TOOL**

- Adjustable to enable use on cylinders between 50 and 180mm diameter
- Spring tension adjustment to give a positive cutting action
- Suitable for use with air tools
- Supplied with 280 grit stones



ITEM ID:	Size
AT040	Engine cylinder honing tool
AT040-SM	Replacement 280 grit stones (3 Pieces)







**BRAKE CYLINDER HONING TOOL**

- Adjustable to enable use on cylinders between 20 and 68mm diameter
- Spring tension adjustment to give a positive cutting action
- Suitable for use with air tools
- Supplied with 220 grit stones

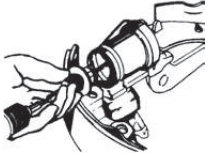

ITEM ID:	Size
AT180	Brake cylinder honing tool
AT180-S	Replacement 220 grit stones (3 Pieces)

**BRAKE SPRING WASHER TOOL**

- Fits both large and small brake spring washers
- Easy to use
- Enables good visibility when assembling or dismantling brake assemblies
- Length 230mm, Weight 153g



Item ID: **AT160**

**BRAKE PIN PUNCH**

- 5.5mm parallel pin punch for removing pins from brake disc pads
- Overall length 165mm to clear most pin holes



Item ID: **AT170**

**DISC BRAKE PAD PULLER**

- Sliding hammer function to help release brake pads from calipers
- Simply hook on to the disc pad with 5mm pins

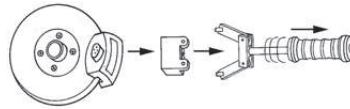

Item ID: **AT330**



**FLARING TOOL SET**

10 Pieces

- Suitable for copper, brass and thin walled aluminium tubing
- 45° tube press flare pipes from 3/16" to 5/8" (4 to 14mm) diameter
- Heavy duty pipe cutter included for cutting pipes up to 32mm (1-1/4") diameter

2 piece double flaring tool set	
Pipe Cutter:	3-32 mm (1/8"-1-1/4")
Adaptors:	4, 4.75 (3/16"), 6 (1/4"), 8 (5/16"), 10, 12, 14 mm

Item ID: **TTTF10**



**BALL JOINT SEPARATORS**

- Simple to use tool for separating ball joints

ITEM ID:	Opening mm	Adjustable Height mm
AT191	29	60
AT192	40	80
AT194	46	100



**BALL JOINT SEPARATOR**

- Simple to use tool for separating ball joints
- Heat treated drop forged steel body and thrust bolt

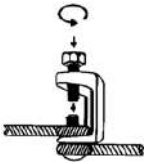

ITEM ID:	Opening mm	Adjustable Height mm
AT195	16	50

**COIL SPRING COMPRESSION SET**

- 3 clamps with safety hooks
- For use when replacing coil springs such as on MacPherson struts
- Simple to use and 250mm capacity

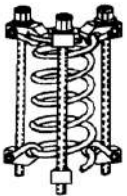
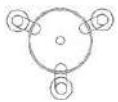

Item ID: AT200

**DEEP 6 POINT IMPACT SOCKETS**



ITEM ID:	Drive	Size	Length mm	Application
920242	1/2"	1-5/16"	78	Wheel nuts
920248	1/2"	1-1/2"	78	Ball Joints
920624N	1/2"	24mm	78	Oil pressure switch
920627N	1/2"	27mm	78	Injectors
920628N	1/2"	28mm	78	Diesel Injectors
920629N	1/2"	29mm	78	Thermostat switch
920630N	1/2"	30mm	78	Hub nuts
920632N	1/2"	32mm	78	Hub nuts/drive shafts
920635N	1/2"	35mm	78	Hub nuts
920636N	1/2"	36mm	78	Hub nuts
940641-C	3/4"	41mm	58	Hub nuts
940258	3/4"	1-13/16"	58	Deep ball joint socket
120955-C	1/2"	TX55	100	Cylinder head bolts
120970-C	1/2"	TX70	125	Cylinder head bolts
AT350	1/2"	29mm	90	Oxygen sensor socket
AT355	3/8"	22mm	90	Oxygen sensor socket
AT360	1/2"	27mm	85	Injector socket
AT365	3/8"	7/8"	80	Vacuum switch socket
AT370	3/8"	11/16"	74	Oil sender socket
AT375	1/2"	7/8"	50	Heated oxygen sensor socket
AT380	3/8"	7/8"	30	Offset Oxygen sensor socket





## AUTOMOTIVE SOCKET SET



- All the most commonly used specialist automotive sockets in one handy set
- Includes sockets for removing and installing injectors, oil sender and vacuum switches as well as various oxygen sensors

3/8" Drive Sockets:		
22 mm	Length: 90 mm	Oxygen sensor socket for Mitsubishi, Nissan, Opel, Vauxhall & VW
7/8"	Length: 80 mm	Vacuum switch socket
1-11/16"	Length: 74 mm	Oil sender socket
7/8"	Length: 30 mm	Offset oxygen sensor socket
1/2" Drive Sockets:		
29 mm	Length: 90 mm	Oxygen sensor socket for GM
27 mm	Length: 85 mm	Injector socket for M24
7/8"	Length: 50 mm	Heated oxygen sensor socket

Item ID: **TTSS07**

## TYRE LEVERS

- Traditional flat design for easy use
- Manufactured in medium carbon steel (HRC40 +/-2%) for high leverage



ITEM ID:	Size mm	Size AF
AT20512	304	12
AT20516	406	16
AT20520	508	20
AT20524	609	24

## TELESCOPIC WHEEL WRENCHES

- 1/2" drive telescopic wheel wrench
- Extends from 14" (35cm) to 21" (55cm) making it ideal for keeping in the car
- Chrome vanadium steel for added strength and higher torque
- Supplied with a double ended impact sockets



ITEM ID:	Drive	Size mm	Weight g
1202	1/2"	17 x 19	900
1202A	1/2"	21 x 22	905

## DOUBLE ENDED WHEEL NUT SOCKETS

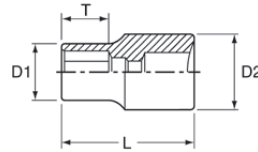

- Double ended 1/2" drive socket to give two sizes in one socket
- Chrome molybdenum for use with power tools
- Black phosphate finish for easy identification as an impact socket accessory

ITEM ID:	Size mm	L mm	D1 mm	D2 mm
9291719	17 / 19	58	26	28
9292122	21 / 22	58	30	32



## WHEEL NUT SOCKET SET



- Includes the most commonly used wheel nut socket sizes
- Chrome molybdenum for use with power tools
- Black phosphate finish for easy identification as an impact socket

3" Extension bar
Double Ended Wheel Nut Sockets:
17 x 19mm, 21 x 22mm

Item ID: **9203N1**



**WHEEL NUT SOCKETS**

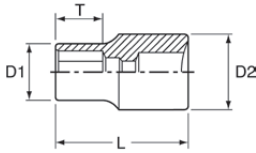

- Thin wall design for reaching in to recesses
- Protective sleeve for use on alloy wheels
- DIN standard design for use with a retaining pin and ring
- Chrome molybdenum for use with power tools
- Ring and pin fixing hole on the female end to secure the socket to the air gun

ITEM ID:	Size mm	L mm	T mm	D1 mm	D2 mm	g
920517N	17	85	27	26	32	260
920519N	19	85	27	29	32	270
920521N	21	85	27	29	32	380



**WHEEL NUT SOCKET SET**



- Thin wall design for reaching in to recesses
- Protective sleeve for use on alloy wheels
- DIN standard design for use with a retaining pin and ring
- Chrome molybdenum for use with power tools
- Ring and pin fixing hole on the female end to secure the socket to the air gun

Item ID: **9203N**



**WHEEL TOOL SET**



- 17" 1/2" drive flex handle for shifting stubborn wheel nuts
- A short extension bar for reaching into recessed wheel rims
- Long reach sockets with protective nylon sleeves to avoid damage to wheels
- Tools are held in place using three colour pre-cut EVA foam

1/2" Drive Accessories:
17" Flex Handle, 5" Extension bar
Impact Wheel Nut Sockets:
17, 19, 21mm

Item ID: **TEXW05**



**BICYCLE TOOL KIT**

- Designed for cyclists to carry easily
- Includes hexagon, TX and screwdriver keys together with a tyre lever and chain repair tool
- Chrome nickel finish
- Supplied in a handy fold up aluminium case

Ergonomically Designed Aluminium Holder, Tyre Lever, Chain Tool			
Individual Keys:			
	mm:	1 x 5.5	
		PH2	
		TX25	TX30
	mm:	4	5 6

Item ID: **1473**





## PROTECTIVE WING COVER

- Full length magnetic strip to hold the cover in place on the vehicle bodywork
- Protects the paintwork from scratching when working on the vehicle
- Heavy duty red PVC with a cloth backing
- Includes the TengTools eyes logo in full colour
- Measures 40 x 107cm to provide a good area of protection

Item ID: FC01

## SUCTION LIFTER

- Single 118mm diameter suction cup
- Handles open or close to engage or release the suction cups
- Ideal for lifting of items with flat, smooth surfaces such as glass up to 30 kilos
- Can also be used to pull out dents in bodywork panels



ITEM ID:	Suction Cups	Max Load Kg	Cup Diameter mm	g
SL01	1	30	118	310

## SUCTION LIFTER

- Two 118mm diameter suction cups
- Simple levers open or close to engage or release the suction cups
- Ideal for lifting of items with flat, smooth surfaces such as glass up to 60 kilos



ITEM ID:	Suction Cups	Max Load Kg	Cup Diameter mm	g
SL02	2	60	118	600

## SUCTION LIFTER

- Three 118mm diameter suction cups
- Simple levers open or close to engage or release the suction cups
- Ideal for lifting of items with flat, smooth surfaces such as glass up to 120 kilos



ITEM ID:	Suction Cups	Max Load Kg	Cup Diameter mm	g
SL03	3	120	118	900

## BODY WORKING HAMMER

- Double headed with a round crown face and straight pein
- Forged alloy steel head for durability
- Mirror polished face for a better contact with the metal
- Hickory handle for a traditional finish



ITEM ID:	Face Diameter mm	g
HMBH01	32.5	400

## BODY WORKING HAMMER

- Double headed with a round crown face and round point pick head
- Forged alloy steel head for durability
- Mirror polished face for a better contact with the metal
- Hickory handle for a traditional finish



ITEM ID:	Face Diameter mm	g
HMBH02	32.5	350





**BODY WORKING HAMMER**

- Double headed with a round crown face and square milled face
- Forged alloy steel head for durability
- Mirror polished crown face for a better contact with the metal
- Milled cross hatched surface on the square head for shrinking metal work on larger flat surfaces
- Hickory handle for a traditional finish



ITEM ID:	Face Diameter mm	 g
HMBH03	32.5	400

**BODY WORKING DOLLIES**

- For panel beating of sheet metal
- Use together with TengTools body working hammers



ITEM ID:	Shape	Length mm	Width mm	Height mm	 g
AT415	Curved	128	58	40	1100
AT420	Heel	80	60	30	900

**DEAD BLOW HAMMERS**

- Dead blow hammer
- Head filled with steel balls to prevent the hammer from bouncing
- Dead blow action particularly useful to reduce marking on the surface being hit



ITEM ID:	Face Diameter mm	 g
HMDH35	35	300
HMDH45	45	490
HMDH55	55	980
HMDH65	65	1365



Get organised

Item Size
PS

**BODYWORK HAMMER SET**

**5**  
Pieces

- A selection of hammers for use in the automotive body shop or metal working area

Hammers:
Dead blow hammers with 35 and 55mm diameter heads, crown face hammers with straight pein, pick heads and square milled face

Item ID: TTPSAD

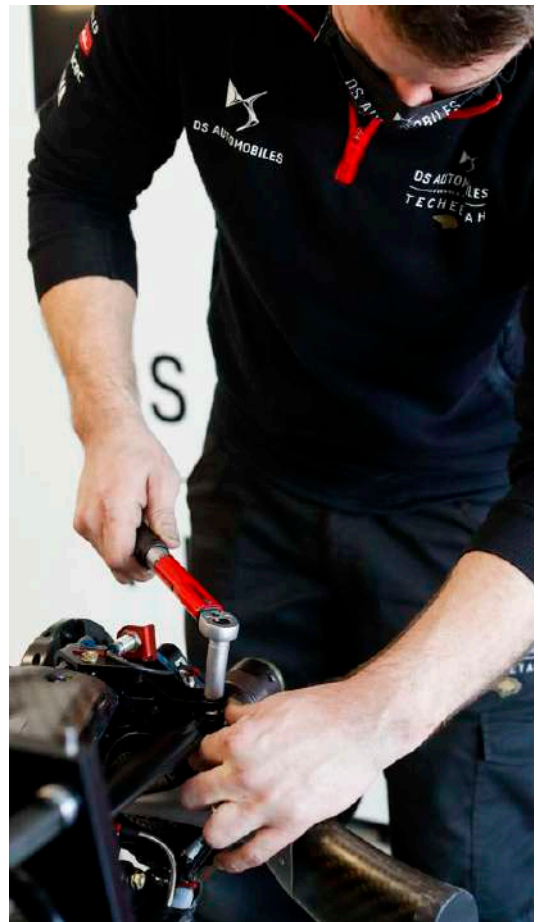

# SERVICE TOOLS

DESIGNED FOR YOU TO **GET THE JOB DONE**

This range of service tools have been developed for you to do what you do best everyday. Here you will find tools that will help you perform most general service tasks more efficiently. All TengTools service tools have been manufactured to exceed the demands of professional users.



A wide selection of twin or triple legged pullers are available



A full range of inspection tools are available including lighting, pick-up tools, and magnetic tools



Increase your efficiency with our range of easy to use, durable riveting tools



Stubborn nuts and bolts don't stand a chance with our range of extraction tools



A wide selection of crimping and wiring tools designed to get the job done, safely





## GREASE GUN

- Lever style grease gun for use with 400g cartridges or up to 500cc bulk grease
- Grease is fed to the high pressure mechanism by fully opening the lever
- Supplied with pipe and hydraulic coupling (thread G(R) 1/8")



Item ID: AT500

## 4" GEAR PULLER

- Simple to use three legged puller for the fast removal of pulleys, wheels and bearings
- Spread of 76mm to 102mm and a maximum reach of 89mm
- The special yoke can also be used to convert from three legged to two legged pulling



Item ID: SP11

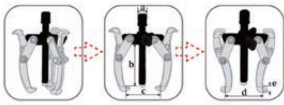

## 7" GEAR PULLER

- Simple to use three legged puller for the fast removal of pulleys, wheels and bearings
- Spread of 75mm to 175mm and a maximum reach of 137mm
- The special yoke can also be used to convert from three legged to two legged pulling



Item ID: SP22

## TWIN/TRIPLE LEG PULLERS

- Simple to use three legged puller for the fast removal of pulleys, wheels and bearings
- Designed for internal or external pulling with easily reversible legs
- The special yoke can also be used to convert from three legged to two legged pulling

ITEM ID:	Clamping Depth mm	Span Width mm	g
SPA11	100	50-100	1080
SPA22	170	60-150	2600

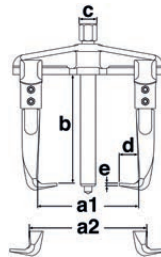

## 2 ARM UNIVERSAL PULLERS

- Simple to use two legged puller for the fast removal of pulleys, wheels and bearings
- Designed for internal or external pulling with easily reversible legs
- Strong drop forged construction for strength and durability

ITEM ID:	a1 mm	a2 mm	b mm	Spindle Thread	Spindle Length mm	c mm	d mm	e mm	g
SP1410	90	133	100	M14 x 1.5	140	17	12	3.4	1100
SP1810	130	170	100	M14 x 1.5	140	17	12	3.4	1300
SP2215	160	220	150	M20 x 2.0	210	22	20	3.8	3200
SP2615	200	256	150	M20 x 2.0	210	22	20	3.8	3600
SP3320	250	325	200	M26 x 2.0	280	27	27	6.2	7800



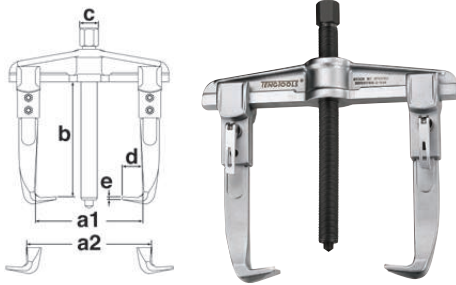

**2 ARM QUICK ACTION UNIVERSAL PULLERS**

- Simple to use two legged puller for the fast removal of pulleys, wheels and bearings
- Quick lock action on the legs for fast adjustment
- Designed for internal or external pulling with easily reversible legs
- Strong drop forged construction for strength and durability

ITEM ID:	a1 mm	a2 mm	b mm	Spindle Thread	Spindle Length mm	c mm	d mm	e mm	g
SP1410Q	90	130	100	M14 x 1.5	140	17	12	3.4	1100
SP1810Q	130	170	100	M14 x 1.5	140	17	12	3.4	1200
SP2215Q	158	209	150	M20 x 2.0	210	22	20	3.8	3000
SP2615Q	200	256	150	M20 x 2.0	210	22	20	3.8	3400
SP3320Q	250	325	205	M26 x 2.0	280	27	27	6.2	7000

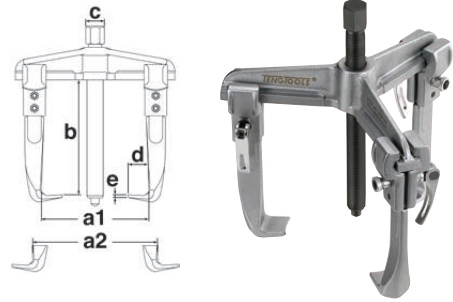

**3 ARM QUICK ACTION UNIVERSAL PULLERS**

- Simple to use three legged puller for the fast removal of pulleys, wheels and bearings
- Quick lock action on the legs for fast adjustment
- Designed for internal or external pulling with easily reversible legs
- Strong drop forged construction for strength and durability

ITEM ID:	a1 mm	a2 mm	b mm	Spindle Thread	Spindle Length mm	c mm	d mm	e mm	g
SP31410Q	90	130	100	M14 x 1.5	140	17	12	3.4	1500
SP31810Q	130	170	100	M14 x 1.5	140	17	12	3.4	1600
SP32215Q	160	210	150	M20 x 2.0	210	22	20	3.8	3900
SP32615Q	205	260	150	M20 x 2.0	210	22	20	3.8	4200
SP33320Q	252	330	205	M26 x 2.0	280	27	27	6.2	8600

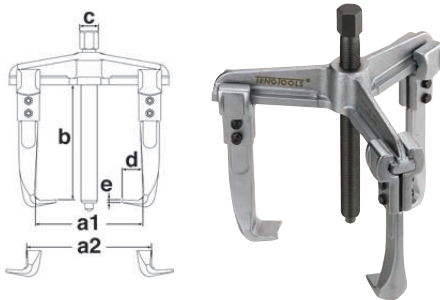

**3 ARM UNIVERSAL PULLERS**

- Simple to use three legged puller for the fast removal of pulleys, wheels and bearings
- Designed for internal or external pulling with easily reversible legs
- Strong drop forged construction for strength and durability

ITEM ID:	a1 mm	a2 mm	b mm	Spindle Thread	Spindle Length mm	c mm	d mm	e mm	g
SP31410	90	140	100	M14 x 1.5	140	17	12	3.4	1400
SP31810	130	180	100	M14 x 1.5	140	17	12	3.4	1600
SP32215	160	220	150	M20 x 2.0	210	22	20	3.8	3500
SP32615	205	260	150	M20 x 2.0	210	22	20	3.8	4200
SP33320	252	330	200	M26 x 2.0	280	27	27	6.2	8800



4 Pieces

**UNIVERSAL PULLER SET**

- Three legged combination puller
- Supplied with an extra yoke for switching to two legged pulling
- Reversible legs for internal or external grip

Pullers:  
Combination twin/triple 6" leg puller with 4" capacity

Item ID: **TT804**







## 2 ARM UNIVERSAL PULLER SET

- A set of 5 two arm pullers complete with stand
- Strong, drop forged design for fast removal of pulleys, wheels and bearings
- Use as a set in a workshop giving a range of spreads from 90 to 250mm internal or 133 to 325mm external pullers
- Easily interchangeable between internal or external

5 Pieces

### 2 Arm Pullers:

90/133mm spread, 130/170mm spread, 158/209mm spread, 200/256mm spread, 250/325mm spread.

Item ID: DIS-SPO5



## 2 ARM QUICK ACTION UNIVERSAL PULLER SET

- A set of 5 two arm pullers complete with stand
- Strong, drop forged design for fast removal of pulleys, wheels and bearings
- Quick lock action on the legs for fast adjustment
- Use as a set in a workshop giving a range of spreads from 90 to 250mm internal or 133 to 325mm external pullers
- Easily interchangeable between internal or external

5 Pieces

### 2 Arm Quick Action Pullers:

90/133mm spread, 130/170mm spread, 158/209mm spread, 200/256mm spread, 250/325mm spread.

Item ID: DIS-SPO5Q

## IMPACT SCREW EXTRACTORS

- For use with a 1/4" drive impact driver
- Spiral design for removing damaged screws
- A quick and easy way to remove broken screws, pipes, bolts and studs



ITEM ID:	Size	Length mm	Depth mm	Height mm	Weight g
SE141	1	50	7	7	12
SE142	2	50	7	7	12
SE143	3	50	7	7	12

## SCREW EXTRACTORS

- Screw extractor
- Tapered designed for removing damaged screws
- Suitable for both clockwise and anti-clockwise threads
- Square shank and manufactured in CR-V 6150 steel hardened to HRC50-52



ITEM ID:	For Drill Hole mm	Weight g
SELO1S	3mm (1/8")	13
SELO2S	4mm (3/16")	22
SELO3S	5mm (15/64")	36
SELO4S	7mm (5/16")	52
SELO5S	9mm (3/8")	148



5 Pieces

## SCREW EXTRACTOR SET

- Tapered designed for removing damaged screws
- Suitable for both clockwise and anti-clockwise threads
- Square shank and manufactured in CR-V 6150 steel hardened to HRC50-52
- Use with drill sizes 3, 4, 5, 7 and 9mm
- Use with the TengTools tap handle (TAP-HNDL)

Item ID: TMSE05S





**SCREW EXTRACTOR SET**

5 Pieces

- Spiral design for removing damaged screws
- A quick and easy way to remove broken screws, pipes, bolts and studs
- Use with drill sizes 7/64", 9/64", 5/32", 1/4" and 19/64"
- Use with the TengTools tap handle (TAP-HNDL)
- Supplied in a handy storage case

Item ID: SE05



2 Pieces

**NUT SPLITTER SET**

- Simply tighten the thread to engage the blade and split stubborn nuts
- Capacities 5 to 20mm and 14 to 27mm

Item ID: NS02

**STUD EXTRACTORS**

- Designed for removing rounded or damaged bolts and studs
- Reversible enabling use on clockwise and anti-clockwise threads
- Use together with a 1/2" drive ratchet and accessories
- Chrome vanadium, satin finish



ITEM ID:	Drive	Size mm
ST12506-C	1/2"	6
ST12508-C	1/2"	8
ST12510-C	1/2"	10
ST12512-C	1/2"	12



**SERVICE KITS FOR STUD EXTRACTORS**

ITEM ID:	For use with:
ST12506RK-1	ST12506-C
ST12508RK-1	ST12508-C
ST12510RK-1	ST12510-C
ST12512RK-1	ST12512-C



**SERVICE KITS FOR NUT SPLITTERS**

ITEM ID:	Description
NS02RKS	Small
NS02RKL	Large





## STUD EXTRACTORS

- Designed for removing rounded or damaged bolt heads, nuts and studs
- Use together with a ratchet and accessories
- Chrome vanadium, satin finish

ITEM ID:	Drive	Size mm	Size AF	L mm	T mm	D1 mm	D2 mm	Weight g
ST38306	3/8"	6	1/4"	27	11	15.9	9.9	21
ST38308	3/8"	8	5/16"	27	11	15.9	12	23
ST38112	3/8"	-	3/8"	27	11	15.9	14.2	22
ST38310	3/8"	10	-	27	11	19	15.3	33
ST38311	3/8"	11	7/16"	27	11	19	15.6	33
ST38312	3/8"	12	-	27	11	19	17.4	33
ST38116	3/8"	-	1/2"	27	11	19	17.7	34
ST38313	3/8"	13	-	27	11	19	18.7	35
ST38314	3/8"	14	9/16"	27	11	22.2	20.7	50
ST38316	3/8"	16	5/8"	27	11	22.2	22.1	50
ST38317	3/8"	17	-	27	11	25.4	24.8	74
ST38122	3/8"	-	11/16"	27	11	25.4	24.8	74
ST12319	1/2"	19	3/4"	44.5	11	27	26.6	167
ST12321	1/2"	21	13/16"	44.5	12.5	32	28	199
ST12322	1/2"	22	7/8"	44.5	12.5	35	30.7	210
ST12324	1/2"	24	15/16"	44.5	12.5	36	32.4	210
ST12325	1/2"	25	1"	44.5	12.5	36	33.4	214

## STUD EXTRACTOR

- For inserting and extracting stud bolts
- One eccentric knurled contact wheel grips the stud against an internal fluting
- Suitable for use with stud bolts from 5.5 to 19mm diameter thread



Item ID: 2300



1/2" DRIVE 11 Pieces

## EXTRACTOR SET

- Includes screw extractors, stud extractors and nut splitters
- Ideal for use with broken nuts, bolts, studs or screws

1/2" Drive Stud Extractors:
6, 8, 10, 12 mm
Screw Extractors:
7/64", 9/64", 5/32", 1/4", 19/64"
Nut Splitters:
5 to 20mm, 14 to 27mm

Item ID: TTSN11



3/8" DRIVE 1/2" DRIVE 18 Pieces

## STUD EXTRACTOR SET

- Includes all the most commonly used sizes from 6mm (5/16") to 25mm (1")
- Designed for removing rounded or damaged bolt heads or nuts
- 4mm parallel pin punch included for clearing debris from the extractors
- Chrome vanadium satin finish
- Designed and manufactured to DIN3120/3124 and ISO2725

3/8" Drive Stud Extractors:
6, 8, 10, 11, 12, 13, 14, 16, 17 mm
5/16", 3/8", 7/16", 1/2", 9/16", 5/8"
1/2" Drive Stud Extractors:
19, 21, 22, 24, 25 mm
3/4", 13/16", 7/8", 15/16", 1"
Parallel Pin Punch:
4mm (150mm length)

Item ID: TTBE18



**PRY BARS**

- Roll or heel type design for opening and separating
- Tapered podger style handle for aligning holes prior to fixing
- Designed for use in construction such as scaffolding, pallet racking, shelving systems and metal panel erection

ITEM ID:	Size AF	Size mm
PB12	12"	300
PB16	16"	400
PB20	20"	500



**PRY BAR SET**

3 Pieces

- Includes roll/heel bars in three sizes to suit different applications

Roll heel bars:
12", 16", 20"

Item ID: TTXPB3

**PRY BARS**

- Heavy duty with a power thru handle for use with a hammer
- Straight handle with a forked tip also suitable for use on nails, etc

ITEM ID:	Size AF	Size mm
PB12A	12"	300
PB18A	18"	450
PB22A	22"	550



**PRY BAR SET**

3 Pieces

- Includes pry bars in three sizes and shapes to suit different applications

Roll heel bars:
12", 18", 22"

Item ID: TTXPB3A

**WRECKING BARS**

- Three functions in one handy tool
- Use as a lever for removing nails, etc.
- Ideal for use in confined spaces
- Sturdy steel construction (1045 medium carbon steel)

ITEM ID:	Overall Length
PF190	190mm (7-1/2")
PF380	380mm (15")



**PRY BAR SET**

4 Pieces



- Includes 3 roll/heel bars and a 20" tyre lever
- Tools are held in place using three colour pre-cut EVA foam

Roll heel bars:
12", 16", 20"
Tyre Lever:
20"

Item ID: TEXPB4





## RATCHET ACTION CRIMPING PLIER

- Interchangeable ratchet crimping tool
- Automatic locking mechanism to ensure a consistent and correct crimping action
- Cutting function for M2 to M5 bolt sizes
- Use on insulated, non insulated terminals and connectors



Item ID: CP52

## SPARE HEADS FOR CP52

ITEM ID:	Insulated Terminals mm <sup>2</sup>	Non-Insulated Terminals mm <sup>2</sup>
CP04RK1	0.324 – 5.261	
CP04RK2		0.324 – 3.31
CP04RK3	0.3 – 8.0	

## RATCHET ACTION CRIMPING PLIER

- Compound ratchet action giving 30% extra strength
- Suitable for use with red, blue and yellow insulated terminals and connectors
- Wire stripping capacity from 0.75 to 6mm
- Automatic locking mechanism to ensure a consistent and correct crimping action
- Cutting function for M2 to M5 bolt sizes



Item ID: CP58

## 9" CRIMPING PLIER AND WIRE STRIPPER

- Use on insulated, non insulated terminals and connectors
- Wire stripping capacity from 0.75 to 6mm
- Cutting function for M2 to M5 bolt sizes
- Plastic grips for more comfortable use



Item ID: CP50

## 9" CRIMPING PLIER AND WIRE STRIPPER

- Use on insulated, non insulated terminals and connectors
- Wire stripping capacity from 0.75 to 6mm
- Cutting function for M2 to M5 bolt sizes
- Plastic grips for more comfortable use



Item ID: CP51

## CRIMPING PLIER AND WIRE STRIPPER

- Use on insulated, non insulated terminals and connectors
- Wire stripping capacity from 0.8 to 3.2mm
- Cutting capacity 1.0mm copper cable
- Return spring for repeated use
- Locking action for easier storage



Item ID: CP53





**WIRE STRIPPING TOOL**

- Includes wire cutting and crimping functions
- Easily strips cable between 0.13 and 8.0mm
- Suitable for crimping insulated and non insulated terminals and connectors
- Return spring action for easier repeated use



Item ID: CP60

Get organised!	
Trey Size	
TT	



**CRIMPING PLIER SET**

4 Pieces

- Interchangeable ratchet crimping tool
- Automatic locking mechanism to ensure a consistent and correct crimping action
- Cutting function for M2 to M5 bolt sizes
- Includes a range of interchangeable heads
- Use on insulated, non insulated terminals and connectors

<b>Crimping Tool:</b>
Changeable ratchet crimping tool for insulated terminals 22-10 AWG
<b>Terminals/connectors:</b>
Die for non-insulated open barrel connector, commercial type 22-12 AWG (0.324 mm <sup>2</sup> - 3.31 mm <sup>2</sup> )
Die for non-insulated terminals 22-8 AWG (0.3 mm <sup>2</sup> - 8 mm <sup>2</sup> )
<b>Other Tools:</b>
Hex key wrench 2.5mm

Item ID: TTCP04



Get organised!	
Trey Size	
TT	

**CRIMPING PLIER SET**

121 Pieces

- Multi function 9" crimping plier and wire stripper
- Use on insulated, non insulated terminals and connectors
- Wire stripping capacity from 0.75 to 6mm
- Cutting function for M2 to M5 bolt sizes
- Includes a range of insulated, non insulated terminals and connectors

<b>Crimping Tool:</b>
Multi function CP50 crimping tool
<b>Terminals/connectors:</b>
Red #6 ring terminals x 20
Blue #8 spade terminals x 20
Red butt connectors x 20
Blue butt connectors x 20
Blue 6.3x0.8mm female connectors x 20
Blue 6.3x0.8mm male connectors x 20

Item ID: TTCP121



**WIRE STRIPPING TOOL**

- Easy to use pistol grip action
- Hardened SK5 steel blade for fast accurate wire stripping
- Wire stripping capacity 24-10AWG or 0.2 to 6mm
- Built in wire cutter cuts up to 2mm diameter electrical wire

Item ID: CP55





## WIRE TWISTING PLIER

- Normally used for wire locking nuts particularly in safety critical areas
- Slim nose design for optimum manoeuvrability
- Heavy duty locking jaws and return spring for durability and easier use
- Forged high carbon steel with polished jaws
- 1.0mm cutting capacity for stainless steel and inconel wire



ITEM ID:	LENGTH		
	Inch	mm	
AT605	6	150	250

## VOLTAGE TESTER

- Insulated voltage tester for use from 100 to 250 volts
- Overall length 145mm, blade length 70mm



Item ID: MDV9855



## CABLE TIE GUN

- Ideal for repeated actions
- Works with plastic cable ties from 2.2 to 4.8mm width
- Adjustable tensile strength to avoid over tightening

Item ID: CTG01

## CIRCUIT TESTER

- Brass with steel probe and screw on cover
- Suitable for use between 6 and 24 volts
- 850mm cable with simple alligator grip
- Replacement bulb widely available (24 volt, 5 watt festoon type bulb)
- Simple to use to check if circuits are live and intact



Item ID: 9850



## DIGITAL MULTIMETER

- Ideal for automotive or industrial maintenance
- 13mm digital display and fold out stand for easier use
- Use to measure voltage in DC or AC and DC current
- Includes a diode and continuity tester
- Measure temperature with the temperature probe
- Hold function and display back light
- Supplied with test leads
- Uses a 9 volt battery (supplied)
- CAT I 600 volts, CAT II 300 volts, IEC61010

### Specifications:

DC Voltage	Volts	200-200mV – 20-200-250V
AC voltage	Volts	200-250V
Resistance	Ohms	200Ω - 2-20-200 KΩ -20MΩ
Temperature	°Celsius	-40 to +1,000

Item ID: DM500





### DIGITAL MULTIMETER

- Ideal for automotive or industrial maintenance
- Extra large digital display with 16mm digits
- Fold out stand for easier use
- Use to measure voltage in DC or AC and DC current
- Includes a diode and continuity tester
- Measure temperature with the temperature probe
- Supplied with test leads
- Uses 2 AAA batteries (supplied)
- CAT I 600 volts, CAT II 300 volts, IEC61010

#### Specifications:

DC Voltage	Volts	250V
AC voltage	Volts	250V
Resistance	Ohms	200Ω - 2-20-200 KΩ -20MΩ
Temperature	°Celsius	-40 to +1,000

Item ID: **DM550**

### PIPE CUTTER

- Designed for cutting copper and brass pipes
- Capacity 3 to 22mm (1/8" to 7/8")
- One cutting wheel and two rollers to give a consistent and straight cutting edge
- Ideal for use in confined spaces



Item ID: **TF22**

### PIPE CUTTER

- Heavy duty cutter complete with a spare blade
- A retractable reamer is built in to the frame to deburr rough edges
- Capacity 3 to 32mm (1/8" to 1-1/4")
- One cutting wheel and two rollers to give a consistent and straight cutting edge



Item ID: **TF30**

### SPARE PIPE CUTTER BLADES

- 2 spare pipe cutter cutting wheels
- Suitable for TengTools TF22 and TF30 pipe cutters



Item ID: **TF2230RK**

### PIPE CUTTER

- Heavy duty cutter with a light weight aluminium frame
- A retractable reamer is built in to the frame to deburr rough edges
- Capacity 6 to 76mm (1/4" to 3") in thin and thick walled copper, brass and aluminium pipe
- Also suitable for cutting plastic pipes with a diameter of 16 to 76mm (5/8" to 3")
- One cutting wheel and two rollers to give a consistent and straight cutting edge



Item ID: **TF76**

### SPARE PIPE CUTTER BLADES

- 5 spare pipe cutter cutting wheels
- Suitable for TengTools TF76 pipe cutters



Item ID: **TF76RK**

### PIPE CUTTER

- Cuts PEX or XLPE polythene tubing and other similar soft plastic piping up to 42mm diameter
- Gives a right angled and burr free cut
- A pistol grip style handle for more comfortable use
- A simple ratchet mechanism engages the cutter step by step to give more control over the cutting action



Item ID: **TFP01**



## SPARE PIPE CUTTER BLADES

- Replacement cutting blade for the TengTools TFPO1 pipe cutter



Item ID: TFPO1RK

## PIPE CUTTER

- Cuts PEX or XLPE polythene tubing and other similar soft plastic piping up to 42mm diameter
- Gives a right angled and burr free cut
- Designed to give a more comfortable grip
- A simple ratchet mechanism engages the cutter step by step to give more control over the cutting action



Item ID: TFPO2

## SPARE PIPE CUTTER BLADES

- Replacement cutting blade for the TengTools TFPO2 pipe cutter



Item ID: TFPO2RK

## ROTATING PIPE CUTTERS

- Rotating pipe cutter
- Ideal for cutting plastic, brass and copper pipes
- Simply rotate around the pipe to create a clean and straight cut



ITEM ID:	Pipe Diameter mm
TFA10	10
TFA12	12
TFA15	15
TFA22	22
TFA0252RK	5 spare wheels

## CHAIN PIPE CUTTER

- For cutting thin walled pipes in stainless steel, copper, & pvc up to a thickness of 1.5mm
- Self locking with a non-pinch, one hand operation for easy use
- A locking nut on the adjustment knob can be used to preset the capacity
- 15 cutting wheels on the chain for an easy cutting action



Item ID: TF300

## REPLACEMENT PIPE CUTTER CHAIN

- Replacement chain for the TengTools TF300 pipe cutter
- Fittings included



Item ID: TF300RK

## PIPE REAMER

- For deburring copper, aluminium and brass pipes
- Suitable for pipe diameters from 3 to 41mm
- Cutters at both ends for internal and external deburring



Item ID: DBT41

## ALUMINIUM PIPE REAMERS

- For deburring pipes of all types
- Cutters at both ends for internal and external deburring



ITEM ID:	Pipe Diameter mm
DBT35	8 to 35mm
DBT54	10 to 54mm



**DEBURRING TOOL**

- Suitable for deburring operations on pipes, holes, edges, etc
- HSS blade knives are swivel mounted to automatically adapt to the shape of the piece
- Supplied with 2 HSS knife blades



ITEM ID:	Description
DET01	Deburring tool
DET01RK	2 spare blades

**DEBURRING TOOL**

- Suitable for deburring operations on pipes, holes, edges, etc
- HSS blade knives are swivel mounted to automatically adapt to the shape of the piece
- Handy pocket clip for added convenience



Item ID: **DET02**



Get organised!	
Trey Size	
TT	

**PIPE CUTTER SET**

6 Pieces

- For cutting plastic, copper and brass pipes from 3 to 22mm diameter
- Deburring tool included for tidying up any sharp edges

Pipe Cutters:
Capacity: 10, 12, 15, 22 mm
Adjustable pipe cutter capacity: 3-22 mm
Accessories:
Deburring tool

Item ID: **TTTC06**

**TELESCOPIC BASIN TAP WRENCH**

- For reaching taps behind the bath or basin
- Spring loaded serrated jaw quickly grips on nuts and pipes
- Capacity 32 to 48mm
- Telescopic handle for even easier access in difficult to reach places
- Extends from 275 to 400mm



Item ID: **BWT406**

**CHAIN PIPE WRENCH**

- Fully adjustable heavy duty chain
- Designed for mounting and unmounting pipes, etc.
- Suitable for tasks where round items need to be gripped
- Strong, drop forged steel handle for high leverage
- Grips pipes, etc up to 100mm diameter



Item ID: **9124**







## TENGTTOOLS® RIVET GUNS

- Easy to use
- Ergonomic design
- Durable and long lasting
- Increase your efficiency
- Cost effective



### HAND RIVET GUN

- For professional use in metal work, industry and construction
- Comfortable PVC grip



ITEM ID:	Aluminium mm	Steel mm	Stainless Steel mm	Length mm	Weight g
HR12	2.4/3.2/4.0/4.8	2.4/3.2/4.0/4.8	2.4/3.2/4.0	250	560
HR12RK	Spare parts set				

### HAND RIVET GUN

- Heavy duty steel plate construction
- Jaw and case made from heat treated steel alloy
- Comfortable PVC grip



ITEM ID:	Aluminium mm	Steel mm	Length mm	Weight g
HR14	2.4/3.0/3.2	2.4/3.0/3.2	270	627
HR14RK	Spare parts set			

### HAND RIVET GUN

- For professional use in metal work, industry and construction
- Comfortable PVC grip



ITEM ID:	Aluminium mm	Steel mm	Stainless Steel mm	Length mm	Weight g
HR30R	2.4/3.0/3.2/4.0/4.8	2.4/3.0/3.2/4.0/4.8	2.4/3.0/3.2/4.0/4.8	270	560
HR30RRK-1	Service Kit - Replacement nose pieces				
HR30RRK-2	Service Kit - Jaw pusher assembly				



**HAND RIVET GUN**

- Aluminium alloy, forged steel upper handle with heat treated jaws for durability and easier use
- Comfortable PVC grip



ITEM ID:	Aluminium mm	Steel mm	Length mm	 g
HR01	2,4/3,2/4,0/4,8	2,4/3,2/4,0/4,8	250	560
HR01RK	Spare parts set			

**HAND RIVET GUN WITH SWIVEL HEAD**

- Swivel head function to enable use at an angle or in confined spaces
- For professional use in metal work, industry and construction
- Comfortable PVC grip



ITEM ID:	Aluminium mm	Steel mm	Stainless Steel mm	Length mm	 g
HR360R	2,4/3,0/3,2/4,0/4,8/5,0	2,4/3,0/3,2/4,0	2,4/3,0/3,2	295	712
HR12RK	Spare parts set				

**LAZY TONGUE RIVET GUN**

- For professional use in construction and industrial applications
- Lazy tongue design and function gives an increased riveting force
- Suitable for use in confined spaces
- 3 jaw sizes included
- Nose bushes for rivet diameter 3.2, 4.0, 4.8, 6.0 and 6.4mm



ITEM ID:	Description
HRLT01	Rivet Gun
HRLT01RK	Spare parts set

**LONG HANDLED RIVET GUN**

- For professional use in construction and industrial applications
- Two handed grips gives a much higher capacity
- 3 jaw sizes included
- Plastic container collects the spent mandrels
- Nose bushes for rivet diameter 3.2, 4.0, 4.8, 6.0 and 6.4mm



ITEM ID:	Description
HRLR01	Rivet Gun
HRLR01RK-2	Service Kit - Replacement nose pieces
HRLR01RK-3	Service Kit - Jaw pusher assembly

**NUTSERT GUN**

- Aluminium alloy, forged steel upper handle with heat treated jaws
- Quick change, lockable threaded mandrels
- Mandrels for M3, M4, M5 and M6 included
- Comfortable PVC grip

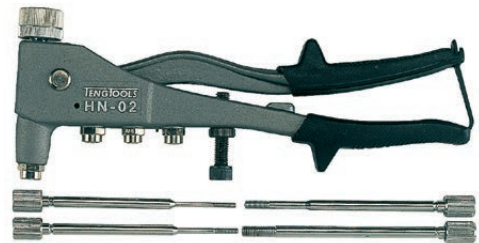

ITEM ID:	Aluminium mm	Length mm	 g
HN02	M3 x 0.5, M4 x 0.7, M5 x 0.8, M6 x 1.0	250	800
HN02RK	Spare parts set		

**LONG HANDLED NUTSERT GUN**

- For professional use in construction and industrial applications
- Two handed grips gives a much higher capacity
- Draw rod compound action for quick loading and unloading
- Mandrels for M5, M6, M8 and M10 included
- Supplied in a metal case for storage and safe keeping



ITEM ID:	Aluminium mm	Length mm	 g
HRLN65N	M5, M6, M8, M10	530	1800
HRLN65NRK-1	Spare parts set		





81 Pieces

## RIVET GUN SET

- Aluminium alloy, forged steel upper handle with heat treated jaws for durability
- Suitable for aluminium and steel rivets from 2.4 to 4.8mm and stainless steel rivets up to 4.0mm
- Includes 75 assorted rivets in individual storage compartments

Hand rivetter:
4 nozzles to suit aluminium/steel blind rivets (2.4, 3.2, 4.0, 4.8 mm)
Aluminium rivets:
2.4mm (3/32") x 20 black
3.2mm (1/8") x 20 black
4.0mm (5/32") x 20 black
4.8mm (3/16") x 20 black
Accessories:
Nozzle wrench

Item ID: **TTHR81**



81 Pieces

## NUTSERT GUN SET

- Aluminium alloy, forged steel upper handle with heat treated jaws for durability
- Quick change, lockable threaded mandrels
- Mandrels for M3, M4, M5 and M6 included
- Includes 75 assorted nutserts in individual storage compartments

Nutsert Tool:
4 quick change mandrels (M3 x 0.5, M4 x 0.7, M5 x 0.8, M6 x 1.0)
Aluminium rivets:
M3 x 20 pieces
M4 x 20 pieces
M5 x 20 pieces
M6 x 15 pieces
Accessories:
Nose piece wrench

Item ID: **TTNR81**



81 Pieces



## RIVET GUN SET

- Aluminium alloy and forged steel construction
- Light weight design for more comfortable use
- PVC grip for added comfort
- Suitable for use with 2.4, 3.2, 4.0 and 4.8mm rivets
- Selection of rivets included
- Tools are held in place using three colour pre-cut EVA foam

Hand rivetter:
4 nozzles to suit aluminium/steel blind rivets (2.4, 3.2, 4.0, 4.8 mm)
Aluminium rivets:
2.4mm (3/32") x 20 black
3.2mm (1/8") x 20 black
4.0mm (5/32") x 20 black
4.8mm (3/16") x 20 black
Accessories:
Nozzle wrench

Item ID: **TEAHR81**

## SCRIBER

- Knurled handle to give a better grip when scribing or marking materials
- Handy pocket clip for storing while being used



ITEM ID:	Length mm	Diameter mm
SCR01	135	7

**SCRIBER**

- Hard tungsten carbide tip (K20 grade) for durability and clear marks when scribing
- Handy pocket clip for storing while being used



ITEM ID:	Length mm	Diameter mm
SCRO2	150	6

**CLAW PICK UP TOOL**

- Excellent for reaching small items lost in hidden areas
- Flexible wire with non magnetic claws for minimal interference
- Press action to expand and contract the jaws to easily grip items
- Overall length 600mm

Item ID: **AT135****CLAW PICK UP TOOL**

- Excellent for reaching small items lost in hidden areas
- Flexible wire for minimal interference
- Magnetic collar to retrieve ferrous material items
- Press action to expand and contract the jaws to easily grip items
- Overall length 600mm

Item ID: **AT135M****TELESCOPIC MAGNIFYING GLASS**

- Adjustable head to help find items
- Ideal for finding lost nuts and bolts
- Extends to 960mm
- Glass diameter: 60mm
- Includes a pocket clip

Item ID: **581TMG****TELESCOPIC INSPECTION MIRROR**

- Adjustable head to help find items
- Ideal for finding lost nuts and bolts
- Extends to 960mm
- Mirror diameter 57mm
- Includes a pocket clip

Item ID: **581TMI****TELESCOPIC MAGNETIC PICK UP TOOL**

- Extra strong magnet with a 4,500g lifting force
- Ideal for retrieving lost nuts and bolts
- Extends to 760mm
- Includes a pocket clip

Item ID: **581TMP**



## TELESCOPIC MAGNETIC PICK UP TOOL

- Strong magnet with a 200g lifting force
- Ideal for retrieving lost nuts and bolts
- Extends to 55cm



Item ID: **SD501**

## 3 IN 1 INSPECTION TOOL

- Combines a magnet with a mirror and a scribe
- Telescopic with a strong magnet extending to 57cm
- Fully adjustable polished mirror to help locate dropped items
- Screw cap to reveal a handy etching scribe
- Complete with pocket clip for easy storage while working



Item ID: **582MI**

## 2 IN 1 MAGNETIC PICK UP AND PEN

- Combines a magnet with a pen for making notes
- Telescopic with a very strong magnet extending to 63cm
- Screw cap to reveal a handy pen
- Complete with pocket clip for easy storage while working



Item ID: **585MP**



## INSPECTION SET

**3**  
Pieces

- Ideal set for finding and retrieving lost nuts and bolts, etc.
- An extending mirror and magnifier with adjustable heads
- The extending magnetic pick up tool helps retrieve items up to 4,500g
- Mirror & magnifying glass extend to 96cm and the magnet extends to 76cm

### Inspection Tools:

Telescopic magnifying glass  
Telescopic inspection mirror  
Telescopic magnetic pick up tool

Item ID: **TTTM03**



## INSPECTION SET

**8**  
Pieces

- Ideal set for finding and retrieving lost nuts and bolts, etc.
- Includes telescopic magnetic pick up, magnifying glass, inspection mirror, a flexible claw pick up and even an LED torch

### Inspection Tools:

LED flashlight	
Flexible magnetic pick up	length 310mm
Telescopic magnetic pick up	length 160-480mm
38mm magnifying glass 1:3	with magnetic adaptor
38mm inspection mirror	with magnetic adaptor
230mm flexible claw pick up tool	
Batteries AAA (2 pieces)	

Item ID: **TTTM08**





**LED TORCH**

- Satin, chrome plated brass body for a better grip
- Pocket clip for easy storage when working
- 25-30 lumen gives a bright light
- 45 degree light distribution illuminates a wider area
- Requires 2 AAA batteries (not included) typically giving 5.5 hours average usage



Item ID: 585

**3 TO 5 WATT LED TORCH**

- CREE technology to create long lasting 550 lumens LED light
- Slide focus to adjust the beam width
- Beam illuminates up to 250 meters
- Shockproof body and water resistant to IPX6
- Low battery indicator when battery strength falls below 15%
- Compact size (195mm length) for easy storage
- Requires 6 x AAA batteries (not included) for up to 15 hours usage



Item ID: 583N

**1 WATT LED TORCH**

- CREE technology to create long lasting 100 lumens LED light
- Slide focus to adjust the beam width
- Beam illuminates up to 60 meters
- Shockproof body and water resistant to IPX6
- Pocket clip and pocket sized (135mm length) for easy storage
- Requires 2 x AAA batteries (not included) for up to 12 hours usage



Item ID: 581N

**1 TO 3 WATT LED TORCH**

- CREE technology to create long lasting 250 lumens LED light
- Slide focus to adjust the beam width
- Beam illuminates up to 150 meters
- Shockproof body and water resistant to IPX6
- Low battery indicator when battery strength falls below 15%
- Pocket sized (138mm length) for easy storage
- Requires 3 x AAA batteries (not included) for up to 5 hours usage



Item ID: 582N

**LED HEAD LAMP**

- Adjustable head band for a comfortable fit
- CREE technology to create a brighter, long lasting LED light
- Choice of two modes - steady or flashing
- Requires 3 AA batteries (not included)
- Ideal for illuminating the work area while keeping the hands free

**Specification:**

Width	mm	50
Height	mm	50
Length	mm	55
Luminous flux	lumen	250
Weight	g	110

Item ID: 586A

**LED HEAD LAMP**

- Adjustable head band for a comfortable fit
- CREE technology to create a brighter, long lasting LED light
- Choice of two modes - high beam or low beam
- Requires 3 AA batteries (not included)
- Ideal for illuminating the work area while keeping the hands free

**Specification:**

Width	mm	50
Height	mm	50
Length	mm	55
Luminous flux	lumen	250
Weight	g	110

Item ID: 586C





## FLEXIBLE LED LIGHT

- 3 LED diodes give a good strong light
- Fully flexible neck to give a wide range of adjustment
- Magnetic attachment for fixing quickly and simply with no drilling required
- Can be easily fitted to any flat ferrous material surface
- Requires 3 LR44 batteries (not included)

ITEM ID:	Length mm	Diameter mm	Light Lumen	Power W	Weight g
587M	370	25	76.5	0.0009	67

## FLEXIBLE LIGHT

- Flexible and adjustable to illuminate work areas
- Magnet on the end makes it ideal for seeing and then retrieving items from confined spaces
- Requires 2 AA batteries (not included)



Specification:		
Total length	mm	595
Flexible length	mm	400
Outside diameter	mm	10
Maximum magnetic force	g	750

Item ID: 586

## MAINS ADAPTORS FOR 587H MAGNIFYING GLASS

ITEM ID:	Region
587AE	Europe
587AU	UK
587AA	Aus / NZ



## MAGNIFYING GLASS

- Hand held magnifying glass
- 14 LED bulbs in a ring around the glass to illuminate the subject being viewed
- Requires 2 AAA batteries (not included)
- Mains adaptors available

ITEM ID:	Magnification	Diameter mm	LED Output W	Lumens
587H	3	100	1.3	72



## KNEELING PAD

- Handy kneeling pad made from hard wearing EVA
- 30.5mm thick EVA provides a good cushion area for the knees
- Ideal for use when working on a hard floor surface
- 450x210mm

Item ID: KPO1



## KNEELING PAD

- Handy kneeling pad made from hard wearing EVA
- 30.5mm thick EVA provides a good cushion area for the knees
- Ideal for use when working on a hard floor surface
- 880x300mm

Item ID: KPO2



**KNEELING PAD**

- Handy kneeling pad made from hard wearing EVA
- 30.5mm thick EVA provides a good cushion area for the knees
- Ideal for use when working on a hard floor surface
- Individual cut out areas create storage spaces for small components
- 480x320mm

Item ID: **KP03**



**MECHANICS STOOL**

- Adjustable height to ensure a comfortable working position
- Padded seat with the TengTools logo
- Swivel castors to move around easily
- Handy storage shelf in the bottom of the stool keeping components close to hand

Specification:		
Seat cushion diameter	mm	360
Storage area	mm	310x310
Adjustable height	mm	420-500
Weight	kg	6.3

ITEM ID:	Description
TCA06	Mechanics stool
TCA06RK	Spare wheel set



**MECHANICS CREEPER**

- Six sturdy wheels and a strong construction
- Padded cushion with the TengTools logo
- Recesses in the frame for the elbows make the creeper more comfortable to use

Specification:		
Width	mm	500
Height	mm	155
Length	mm	1,050
Weight	kg	8.5

Item ID: **TCA07**

**MAGNETIC BRACELET**

- An adjustable 340mm length bracelet
- Magnetic disc for holding metal items while working
- Ideal for use with nails, screws, nuts and bolts
- Holds items within easy reach while working



Item ID: **583M**



**MAGNETIC BITS TRAY**

- 6" (150mm) diameter
- Stainless steel for longer life
- Plastic enclosed magnet to avoid damage to paintwork, etc
- Use for screws, nuts, washers, etc when disassembling
- Can be secured on it's side as well as upside down

Item ID: **580**





### LARGE MAGNETIC BITS TRAY

- Square to hold more bulky items
- Stainless steel for longer life
- 4 plastic enclosed magnets to avoid damage to paintwork, etc
- Use for screws, nuts, washers, etc when disassembling
- Can be secured on it's side as well as upside down
- Ideal for use as a parts washing tray

Item ID: 580S



### LARGE MAGNETIC BITS TRAY

- Deep and rectangular to hold more bulky items
- Stainless steel for longer life
- 2 plastic enclosed magnets to avoid damage to paintwork, etc
- Use for screws, nuts, washers, etc when disassembling
- Can be secured on it's side as well as upside down

Item ID: 580A



### MAGNETIC PLASTIC BOWL

- Creates storage for small parts quickly and easily with no drilling required
- Can be easily fitted to any flat ferrous material surface
- Powerful magnet for secure fixing
- Ideal for using on the side of a roller cabinet

ITEM ID:	Diameter mm	Weight g
580Q	112	191
580R	150	400

### MAGNETIC ANGLE BLOCKS

- Ideal for holding sheet metal, pipes and tubes when welding
- Use to hold the pieces prior to and during welding
- Holds the material at 45° or 90° to ensure an exact angle
- Can be used on flat or round surfaces of ferrous materials



ITEM ID:	Holding Area mm	Max Width mm	Height mm	Magnetic Force N
MH75	75	120	82	27
MH90	90	160	100	27



**QUICK CLAMPS**

- For internal or external clamping
- Fast action lever clamp with a unique design
- Powerful lever bar makes it easy to apply the correct clamping force
- Bottom mounted lever makes the clamp quick and comfortable to use
- Easy release button makes it equally quick and easy to unclamp
- Protective caps on the pressure plates to prevent damage
- Bi-material grip on the handle for a better grip



ITEM ID:	Clamping Force N	Span Width mm	Clamping Capacity mm	 g
CMQ150	1580	85	150	580
CMQ300	1580	85	300	680
CMQ450	1580	85	450	790
CMQ600	1580	85	600	890

**QUICK CLAMPS**

- For internal or external clamping
- Fast action lever clamp with a unique design
- Powerful lever bar makes it easy to apply the correct clamping force
- Top mounted lever makes the clamp quick and comfortable to use
- Easy release button makes it equally quick and easy to unclamp
- Protective caps on the pressure plates to prevent damage to the item being clamped
- Bi-material grip on the handle for a better grip



ITEM ID:	Clamping Force N	Span Width mm	Clamping Capacity mm	 g
CMQL150	1780	80	150	670
CMQL300	1780	80	300	780
CMQL450	1780	80	450	900

**SCREW CLAMPS**

- Reinforced malleable cast iron arms for increased strength
- High quality profiled rail with serrations for stability
- Protective caps on the pressure plates to prevent damage to the item being clamped
- Bi-material grip on the handle for a better grip



ITEM ID:	Clamping Force N	Span Width mm	Throat Depth mm	Bar Dimension mm	 g
CMD12	1961	120	60	20.0 x 5.0	430
CMD16	2648	160	80	25.0 x 6.0	750
CMD20	3922	200	100	27.0 x 7.0	1120
CMD25	4903	250	120	29.0 x 9.0	1500
CMD30	4903	300	120	29.0 x 9.0	1590
CMD30A	5393	300	140	32.0 x 10.0	2050
CMD40	5393	400	140	32.0 x 10.0	2260
CMD40A	5393	400	175	32.0 x 10.0	2330
CMD50	4903	500	120	29.0 x 9.0	1940
CMD80	4903	800	120	29.0 x 9.0	2480

**F CLAMPS**

- 180° swivel handle for extra torque and fast action
- Swivelling pressure plate to grip even when tilted
- High quality construction for increased clamping strength
- Bi-material grip on the handle for a better grip



ITEM ID:	Span mm	Throat Depth mm	Bar Dimension mm	 g
CMF16T	160	80	16.5x7.5	570
CMF20T	200	100	19.5x9.5	1010
CMF25T	250	120	22x10.5	1330
CMF30T	300	140	25x12	1960
CMF35T	300	100	25x12	1140







## F CLAMPS

- Fixed handle for fast action tightening and loosening
- Swivelling pressure plate to grip even when tilted
- High quality construction for increased clamping strength



ITEM ID:	Span mm	Throat Depth mm	Bar Dimension mm	 g
CMF16	160	80	16.5x7.5	480
CMF20	200	100	19.5x9.5	900
CMF25	250	120	22x10.5	1210
CMF30	300	140	25x12	1800
CMF35	300	120	25x12	1720

## FAST ACTION CLAMPS

- Ratchet lever mechanism for high pressure, fast action clamping
- The ratchet action prevents over tightening and resists vibration
- Ergonomic design lever handle with non slip release lever



ITEM ID:	Clamping Force N	Span Width mm	Throat Depth mm	Bar Dimension mm	 g
CMFQ20	3432	200	100	19.5 x 9.5	1130
CMFQ25	3922	250	120	22.0 x 10.5	1500
CMFQ30	4903	300	140	25.0 x 12.0	2260
CMFQ40	5393	400	120	25.0 x 12.0	2400

## HINGE ADJUSTMENT WRENCH

- Specifically designed for adjusting exterior door and window hinges



ITEM ID:	Length mm	Diameter mm	 g
DHW1300	220	13	170

## HINGE ADJUSTMENT WRENCHES

- Specifically designed for adjusting exterior door and window hinges



ITEM ID:	Length mm	Diameter mm	 g
DHW1417	290	14 x 17	310
DHW1922	300	19 x 22	440



**BALL PEIN HAMMERS**

- Double headed with a round pein and ball head
- Fibre glass shafted handle for reduced weight and durability
- A comfortable rubber type handle for a more secure grip

ITEM ID:	Head Weight oz	Overall Weight g	Head Diameter mm	Overall Length mm
HMBP12	12	550	28	280
HMBP16	16	600	30	320
HMBP24	24	1040	35	380
HMBP32	32	1280	39	380

**LUMP HAMMER**

- For heavy duty striking
- Ideal for when extra force is needed
- Hanging hole which can be used together with a safety wire
- Steel handle for extra strength
- A comfortable, perforated rubber type handle

ITEM ID:	Head Weight g	Overall Weight g	Head Diameter mm	Overall Length mm
HMS1250	1250	1609	43	296

**ENGINEERS STYLE HAMMER**

- Double headed with a square pein and a pointed head
- Fibre glass shaft with a comfortable, rubber type handle

ITEM ID:	Head Weight g	Overall Weight g	Head Diameter mm
HMEG300	300	420	300
HMEG500	500	650	320
HMEG800	800	1000	350

**CLAW HAMMERS**

- Double headed with a round pein and claw for removing nails, etc
- Hanging hole which can be used together with a safety wire
- Steel handle for extra strength when levering with the claw
- A comfortable, perforated rubber type handle

ITEM ID:	Head Weight oz	Overall Weight g	Head Diameter mm	Overall Length mm
HMCH08A	8	394	21.6	290
HMCH13A	13	552	27	335
HMCH16A	16	700	27	312
HMCH20A	20	765	30	340

**SOFT FACE HAMMER**

- Double headed with a nylon and a softer rubber type head
- Tubular steel shaft for extra strength
- A comfortable, perforated rubber type handle
- Soft face heads to reduce marking on the surface being hit

ITEM ID:	Weight g	Length mm
HMSF	670	320
HMSFRK	Replacement Head	

**SHOCK ABSORBING CLAW HAMMER**

- Double headed with a round pein and a claw for removing nails, etc
- Hanging hole which can be used together with a safety wire
- One piece forged steel handle for extra strength
- Shock absorbent grip to reduce impact vibration when striking

ITEM ID:	Head Weight oz	Overall Weight g	Head Diameter mm	Overall Length mm
HMCHM16	16	723	29	333





## CARBON FIBRE CLAW HAMMER

- Double headed with a round pein and a claw for removing nails, etc
- Hanging hole which can be used together with a safety wire
- Carbon fibre handle gives extra force on impact
- A comfortable rubber type handle



ITEM ID:	Head Weight oz	Overall Weight g	Head Diameter mm	Overall Length mm
HMCHC16	16	686	28	327

## PARALLEL PIN PUNCHES

- Special tempered steel construction with hardened point for longer life
- Overall length 150mm with hexagon grip and rounded shaft area

ITEM ID:	Type	Size mm	Length mm
PP03	Parallel pin punch	3	150
PP04	Parallel pin punch	4	150
PP05	Parallel pin punch	5	150
PP06	Parallel pin punch	6	150
PP07	Parallel pin punch	7	150
PP08	Parallel pin punch	8	150



## CLAW HAMMER WITH MAGNETIC NAIL HOLDER

- Double headed with a round pein and a claw for removing nails, etc
- Magnetic nail holder in the head for positioning nails on the first strike
- Hanging hole which can be used together with a safety wire
- Steel handle for extra strength when levering with the claw
- A comfortable, perforated rubber type handle



ITEM ID:	Head Weight oz	Overall Weight g	Head Diameter mm	Overall Length mm
HMCH16M	16	678	27.5	341

## CENTRE PUNCHES

- Special tempered steel construction with hardened point for longer life
- Strike with a hammer for marking hard materials such as metal, etc.

ITEM ID:	Size mm	Length mm
CP04	4	150
CP05	5	150
CP08	8	150



## BRICK LAYERS MASONRY HAMMER

- Double headed with a square pein and a pick
- Ideal for cutting, cleaning and setting bricks, stonework or masonry
- A comfortable, perforated rubber type handle
- Hanging hole which can be used together with a safety wire



ITEM ID:	Head Weight oz	Overall Weight g	Head Diameter mm	Overall Length mm
HMBH16	16	733	23	291

## AUTOMATIC CENTRE PUNCH

- Spring is compressed and then released when the tip is pushed down
- Use to create an indentation in the material to be marked
- 1mm diameter tip
- Handy pocket clip for storing while being used



Item ID: SCP01



**COLD CHISELS**

- Special tempered steel construction with hardened 18mm cutting edge for longer life
- For shaping, cutting and chipping hard materials such as metal, stone and concrete

ITEM ID:	Type	Size mm	Length mm
CC150F	Flat cold chisel	18	150
CC200F	Flat cold chisel	25	200
CC250F	Flat cold chisel	25	250
CC240F	Flat cold chisel	26	240



**SAFETY HAND GRIP**

- Heavy moulded impact absorbing hand grip
- For protection when striking with a hammer
- Protective plate improves safety against accidental impact
- Ergonomic design to help avoid injuries to the hand
- For use with TengTools 200, 240 and 250mm cold chisels



ITEM ID:	Length mm	Width mm	g
PCCAP	120	56	45



14 Pieces 

**PUNCH AND CHISEL SET**

- Parallel pin punches, flat cold chisels and centre punches
- High carbon steel hardened to HRC42 and tempered strike ends (HRC40 +/-5) for use with a hammer
- Automatic centre punch with spring loaded stroke for marking points quickly
- Tools are held in place using three colour pre-cut EVA foam

Punches:		
Centre	Length: 150 mm	4, 5, 8 mm, Automatic centre punch
Parallel	Length: 150 mm	3, 4, 5, 6, 7, 8 mm
Flat cold chisels::		
150 mm		Width: 19 mm
200 mm		Width: 25 mm
240 mm		Width: 26 mm
250 mm		Width: 25 mm

Item ID: **TEDPC14**



9 Pieces

**PUNCH AND CHISEL SET**

- Parallel pin punches, flat cold chisels and centre punches
- High carbon steel hardened to HRC42 and tempered strike ends (HRC40 +/-5)for use with a hammer

Punches:		
Centre	Length: 150 mm	5 mm
Parallel	Length: 150 mm	3, 4, 5, 6, 7, 8 mm
Flat cold chisels::		
150 mm		Width: 19 mm
200 mm		Width: 25 mm

Item ID: **TTPC09**





10 Pieces

**PUNCH AND CHISEL SET**

- Parallel pin punches, flat cold chisels and centre punches
- High carbon steel hardened to HRC42 and tempered strike ends (HRC40 +/-5) for use with a hammer
- Supplied with a wall rack for fixing to the wall or a workbench

Punches:		
Centre	Length: 150 mm	5 mm
Parallel	Length: 150 mm	3, 4, 5, 6, 7, 8 mm
Flat cold chisels::		
150 mm		Width: 19 mm
200 mm		Width: 25 mm
250 mm		Width: 25 mm

Item ID: **WRPC10**



6 Pieces

**PARALLEL PIN PUNCH SET**

- Special tempered steel construction with hardened point for longer life
- Overall length 150mm with hexagon grip and rounded shaft area
- Supplied with a handy storage holder

Punches:		
Parallel	Length: 150 mm	3, 4, 5, 6, 7, 8 mm

Item ID: **PPS06**



5 Pieces

**PUNCH AND CHISEL SET**

- Includes a cold chisel, centre punch and 3 parallel pin punches
- Special tempered steel construction with hardened cutting edges and points for longer life
- Supplied in a handy storage holder

Punches:		
Centre	Length: 150 mm	5 mm
Parallel	Length: 150 mm	3, 4, 5 mm
Flat cold chisels::		
150 mm		Width: 19 mm

Item ID: **PCX05**

**WOOD CHISELS**

- Professional quality
- Finely ground and lacquer protected for corrosion protection
- Impact resistant soft grip handle with a percussion cap for striking
- Supplied with a plastic blade cover for safer storage



ITEM ID:	Blade Width mm	Overall Length mm	Weight g
WCC06	6	276	157
WCC08	8	276	159
WCC10	10	276	171
WCC12	12	276	183
WCC14	14	276	179
WCC16	16	276	195
WCC18	18	276	200
WCC20	20	276	212
WCC22	22	276	224
WCC25	25	281	229
WCC32	32	291	289
WCC38	38	305	340



**WOOD CHISEL SET**7  
Pieces

- Includes a range of blade sizes from 6 to 25mm
- Finely ground and lacquer protected for corrosion protection
- Impact resistant soft grip handle with a percussion cap for striking with a hammer
- Each chisel is supplied with a plastic blade cover for safer storage
- Supplied with a wall rack for fixing to the wall or a workbench

## Wood Chisels:

6, 10, 12, 16, 18, 20 &amp; 25 mm

Item ID: **WRWC07****WOOD CHISEL SET**4  
Pieces

- Includes 6, 12, 18 and 25mm blade sizes
- Finely ground and lacquer protected for corrosion protection
- Impact resistant soft grip handle with a percussion cap for striking
- Each chisel is supplied with a plastic blade cover for safer storage
- Supplied in a handy carrying case

Item ID: **WCS04L****WOOD CHISEL SET**4  
Pieces

- Includes 10, 16, 18 and 20mm blade sizes
- Finely ground and lacquer protected for corrosion protection
- Impact resistant soft grip handle with a percussion cap for striking
- Each chisel is supplied with a plastic blade cover for safer storage
- Supplied in a handy carrying case

Item ID: **WCS04S****SAFETY WIRE**

- For securing tools when working at a height
- Locking wire with a spring clip hook at each end plus a fixing wire
- Plastic covered (3mm diameter) stainless steel spiral wire (1mm diameter) with a maximum load of 3 kilos
- Stretches from 430mm to 1.6 meters

Item ID: **SSH01****SAFETY WIRE**

- For securing tools when working at a height
- Locking wire with a spring clip hook at each end plus a fixing wire
- High strength nylon webbing with an elastic inner core with a maximum load of 3 kilos
- Stretches from 750mm to 1.35 meters

Item ID: **SSH02****SAFETY WIRE**

- For securing tools when working at a height
- Locking wire with a spring clip hook at each end plus a fixing wire
- High strength nylon webbing with an elastic inner core with a maximum load of 4.5 kilos
- Stretches from 800mm to 1.35 meters

Item ID: **SSH03**



**SAFETY WIRE**



- For securing tools when working at a height
- Locking wire with a carabiner style hook at one end and an adjustable rope lock on the other
- High strength nylon webbing with an elastic inner core with a maximum load of 4.5 kilos
- Stretches from 860mm to 1.45 meters

Item ID: **SSH04**



**PROTECT  
WHAT  
MATTERS**



Lens Colour	CE scale no.	Visible Light 380-780nm	General Features
 Clear	2-1.2 2C-1.2	90% (UV385)	<ul style="list-style-type: none"> <li>◇ General purpose that provides maximum visibility.</li> <li>◇ Indoor lens, good for mechanical work, or dusk, dawn and night time activities.</li> <li>◇ For shooting indoors when no contrast is needed. An excellent safety lens while hand loading.</li> </ul>
 Amber	2-1.2	86% (UV385)	<ul style="list-style-type: none"> <li>◇ Maximum enhancement of contrast in low light environments i.e. warehouse.</li> <li>◇ Blocks out 87% of blue light with unparalleled level of detail definition &amp; colour recognition.</li> <li>◇ Offers brighter view in early morning or late evening, on cloudy, foggy, or hazy days.</li> <li>◇ Suitable for night shift workers, surface inspection and mechanical work.</li> <li>◇ Recommended for shooting and indoor racquet sports.</li> </ul>
 Smoke	5-2.5	18% (UV385)	<ul style="list-style-type: none"> <li>◇ Transmits all colours at the same level.</li> <li>◇ Protects eyes from excessive glare and high levels of hazardous visible light and ultraviolet radiation without distorting colour perception.</li> <li>◇ Ideal for outdoors, for use on bright days &amp; bright sunlight, but does not enhance target.</li> <li>◇ General purpose safety lens / the most popular tinted lens.</li> </ul>



 Clear

**SAFETY GLASSES**

- Optically neutral lenses with anti-fog and anti-scratch resistance (HC/AF)
- Clear polycarbonate lenses
- Shaped to give a large panorama view and integrated side protection
- Suitable for work wear or for visitor protection wear
- In accordance with EN166 class 1FT

ITEM ID:	Lens	Scratch Resistant	Anti Fog
SG960	Clear	Y	Y



 Amber

**SAFETY GLASSES**

- Optically neutral lenses with anti-fog and anti-scratch resistance (HC/AF)
- Yellow polycarbonate lenses for protection in low light environments
- Shaped to give a large panorama view and integrated side protection
- Suitable for work wear or for visitor protection wear
- In accordance with EN166 class 1FT and EN170

ITEM ID:	Lens	Scratch Resistant	Anti Fog
SG960Y	Amber	Y	Y



 Smoke

**SAFETY GLASSES**

- Optically neutral lenses with anti-fog and anti-scratch resistance (HC/AF)
- Grey/smoke polycarbonate lenses for protection against bright lights
- Shaped to give a large panorama view and integrated side protection
- Suitable for work wear or for visitor protection wear
- In accordance with EN166 class 1FT and EN172

ITEM ID:	Lens	Scratch Resistant	Anti Fog
SG960G	Grey/Smoke	Y	Y



 Clear

**SAFETY GLASSES**

- Optically neutral lenses with anti-scratch resistance (HC)
- Clear polycarbonate lenses
- Shaped to give a large panorama view and integrated side protection
- Suitable for work wear or for visitor protection wear
- In accordance with EN166 class 1FT

ITEM ID:	Lens	Scratch Resistant	Anti Fog
SG960A	Clear	Y	-





Clear

## SAFETY GLASSES

- Sports inspired design for a more stylish pair of protective glasses
- Optically neutral lenses with anti-fog and anti-scratch resistance (HC/AF)
- Soft bridge nose and side pieces for a more comfortable fit
- Clear polycarbonate lenses
- Shaped to give a large panorama view and integrated side protection
- Suitable for work wear or for visitor protection wear
- In accordance with EN166 class 1FT

ITEM ID:	Lens	Scratch Resistant	Anti Fog
SG713	Clear	Y	Y



Smoke

## SAFETY GLASSES

- Sports inspired design for a more stylish pair of protective glasses
- Optically neutral lenses with anti-fog and anti-scratch resistance (HC/AF)
- Soft bridge nose and side pieces for a more comfortable fit
- Grey/smoke polycarbonate lenses for protection against bright lights
- Shaped to give a large panorama view and integrated side protection
- Suitable for work wear or for visitor protection wear
- In accordance with EN166 class 1FT and EN172

ITEM ID:	Lens	Scratch Resistant	Anti Fog
SG713G	Grey/Smoke	Y	Y



Clear

## PROTECTIVE GLASSES

- Red frames with straight arms
- Light and comfortable work wear glasses that give stylish protection
- Impact resistant, clear lenses with high optical clarity
- Conform to EN166, AS/NZS1067

ITEM ID:	Style	Arm Type
SG001	Red Frames	Straight



Clear

## PROTECTIVE GLASSES

- Black frames with straight arms
- Light and comfortable work wear glasses that give stylish protection
- Impact resistant, clear lenses with high optical clarity
- Conform to EN166, AS/NZS1067

ITEM ID:	Style	Arm Type
SG002	Black/Grey Frames	Straight





Clear

**PROTECTIVE GLASSES**

- Black frames with curved arms
- Light and comfortable work wear glasses that give stylish protection
- Impact resistant, clear lenses with high optical clarity
- Conform to EN166, AS/NZS1067

ITEM ID:	Style	Arm Type
SG003	Black Frames	Curved



Smoke

**PROTECTIVE GLASSES**

- Black frames with straight arms
- Tinted glasses to protect against sunlight and bright lights
- Light and comfortable work wear glasses that give stylish protection
- Impact resistant with high optical clarity
- Conform to EN166, AS/NZS1067

ITEM ID:	Style	Arm Type
P-SG02	Black/Grey Frames	Straight



Smoke

**PROTECTIVE GLASSES**

- Red frames with straight arms
- Tinted glasses to protect against sunlight and bright lights
- Light and comfortable work wear glasses that give stylish protection
- Impact resistant with high optical clarity
- Conform to EN166, AS/NZS1067

ITEM ID:	Style	Arm Type
P-SG01	Red Frames	Straight



**PROTECTIVE GLASSES**

- Black frames with curved arms
- Mirror effect glasses to protect against sunlight and bright lights
- Light and comfortable work wear glasses that give stylish protection
- Impact resistant with high optical clarity
- Conform to EN166, AS/NZS1067

ITEM ID:	Style	Arm Type
P-SG03	Black Frames	Curved





# AIR TOOLS

ESSENTIAL FOR ANY **WORKSHOP**

Air is a powerful and versatile resource that can help you get the job done quickly! If you need to cut through steel or machine-tighten a bolt, you will need a certain amount of torque. Choosing a tool for its convenience or cost really won't do any good if it isn't strong enough to get the job done. This range of air tools pack a real punch and have been developed to exceed the demands of a professional auto workshop.



Impact wrenches  
available from 3/8"  
drive to 1" drive

Twin hammer  
mechanism for  
increased torque  
and reduced  
vibration





Ergonomically designed handles for insulation against vibration and cold air

Air tools can operate in areas where other power sources are not available, and they can perform a variety of tasks that electric tools cannot. The tools can withstand various elements, such as dust, heat and water, better than electrical tools. With a simple manufacturing process, their apparatus is less prone to breaking down and they are more lightweight than their electric counterparts.

The range has been developed with 'Typically Teng' features including rubber grips, composite material and reduced vibration to make the tools more user friendly.



The range includes ratchets, saws, blow guns and die grinders



**3/8"**  
DRIVE

## AIR RATCHET

- Reversible for tightening or loosening
- Designed for working in confined areas
- High torque forward and reverse action
- Simple single clutch operation for greater control
- Metal "squeeze action" trigger for easier use
- Handle design insulates against cold air and vibration

SPECIFICATION:			
Square drive	inch		3/8"
Bolt capacity	mm		M10
Free speed	rpm		220
Forward/reverse torque	Nm		41
Forward/reverse torque	ft-lb		30
Sound level *	dB		88
Vibration **	m/s <sup>2</sup>		10
Minimum hose size	inch		3/8"
Air inlet	inch		1/4"
Air consumption at 100% int.	l/min		90.6
Air consumption at 100% int.	cfm		3.2
Air consumption at 15% int.	l/min		14
Air consumption at 15% int.	cfm		0.5
Length	mm		173.9
Weight	kg		0.6

\* A weighted sound pressure level at work station in accordance with EN ISO 15744

\*\* Vibration value according to EN ISO 28927-2

Item ID: **ARRM38**



**1/2"**  
DRIVE

## AIR RATCHET

- Reversible for tightening or loosening
- Designed for working in confined areas
- High torque forward and reverse action
- Simple single clutch operation for greater control
- Metal "squeeze action" trigger for easier use
- Handle design insulates against cold air and vibration

SPECIFICATION:			
Square drive	inch		1/2"
Bolt capacity	mm		M13
Free speed	rpm		160
Forward/reverse torque	Nm		95
Forward/reverse torque	ft-lb		70
Sound level *	dB		92
Vibration **	m/s <sup>2</sup>		6
Minimum hose size	inch		3/8"
Air inlet	inch		1/4"
Air consumption at 100% int.	l/min		113.2
Air consumption at 100% int.	cfm		4
Air consumption at 15% int.	l/min		17
Air consumption at 15% int.	cfm		0.6
Length	mm		277
Weight	kg		1.3

\* A weighted sound pressure level at work station in accordance with EN ISO 15744

\*\* Vibration value according to EN ISO 28927-2

Item ID: **ARR12**





### MINI AIR IMPACT WRENCH

- Three forward steps up to 680Nm
- Compact and lightweight for use in confined spaces
- Extra high torque capacity for the size and weight
- Jumbo clutch mechanism
- Reversible for tightening or loosening
- Forward/reverse button for one handed operation
- Extra lightweight composite housing
- Sound absorbent housing for noise reduction

SPECIFICATION:		
Square drive	inch	1/2"
Bolt capacity	mm	M16
Free speed	rpm	8,000
Max torque (3 steps)	Nm	285/380/680
Max torque (3 steps)	ft-lb	210/280/501
Max reverse torque	Nm	770
Max reverse torque	ft-lb	568
Hammer mechanism	type	Jumbo hammer
Sound level *	dB	102
Vibration **	m/s <sup>2</sup>	7.5
Minimum hose size	inch	3/8"
Air inlet	inch	1/4"
Air consumption at 100% int.	l/min	121
Air consumption at 100% int.	cfm	4.23
Air consumption at 15% int.	l/min	18
Air consumption at 15% int.	cfm	0.6
Length	mm	113
Weight	kg	1.3

\* A weighted sound pressure level at work station in accordance with EN ISO 15744

\*\* Vibration value according to EN ISO 28927-2

Item ID: **ARWM12M**



### AIR IMPACT WRENCH SET

- Compact and lightweight 1/2" drive impact wrench
- For use in confined spaces
- Supplied with stubby 1/2" drive impact sockets
- Supplied in the unique TengTools tray to be used within the Get Organised System

IMPACT SOCKETS - 1/2" STUBBY:		
10, 12, 13, 14, 15, 16, 17, 18, 19, 21, 22, 24 mm		
COMPACT IMPACT WRENCH SPECIFICATION:		
Square drive	inch	1/2"
Bolt capacity	mm	M16
Free speed	rpm	8,000
Max torque (3 steps)	Nm	285/380/680
Max torque (3 steps)	ft-lb	210/280/501
Max reverse torque	Nm	770
Max reverse torque	ft-lb	568
Hammer mechanism	type	Jumbo hammer
Sound level *	dB	102
Vibration **	m/s <sup>2</sup>	7.5
Minimum hose size	inch	3/8"
Air inlet	inch	1/4"
Air consumption at 100% int.	l/min	121
Air consumption at 100% int.	cfm	4.23
Air consumption at 15% int.	l/min	18
Air consumption at 15% int.	cfm	0.6
Length	mm	113
Weight	kg	1.3

\* A weighted sound pressure level at work station in accordance with EN ISO 15744

\*\* Vibration value according to EN ISO 28927-2

Item ID: **TTDAWM13M**





**3/8"**  
DRIVE

### AIR IMPACT WRENCH

- Three forward steps up to 465Nm
- Reversible for tightening or loosening
- Forward/reverse button for one handed operation
- High torque action
- Hard wearing, lightweight aluminium housing
- Twin hammer mechanism for increased torque and reduced vibration
- Handle design insulates against cold air and vibration

SPECIFICATION:		
Square drive	inch	3/8"
Bolt capacity	mm	M13
Free speed	rpm	9000
Max torque (3 steps)	Nm	115/285/465
Max torque (3 steps)	ft-lb	85/210/342
Max reverse torque	Nm	490
Max reverse torque	ft-lb	361
Hammer mechanism	type	Twin hammer
Sound level *	dB	95.4
Vibration **	m/s <sup>2</sup>	4.96
Minimum hose size	inch	3/8"
Air inlet	inch	1/4"
Air consumption at 100% int.	l/min	105
Air consumption at 100% int.	cfm	3.7
Air consumption at 15% int.	l/min	16
Air consumption at 15% int.	cfm	0.6
Length	mm	159.4
Weight	kg	1.5

\* A weighted sound pressure level at work station in accordance with EN ISO 15744

\*\* Vibration value according to EN ISO 28927-2

Item ID: **ARWM38**



**1/2"**  
DRIVE

### AIR IMPACT WRENCH

- Three forward steps up to 930Nm
- Reversible for tightening or loosening
- Forward/reverse button for one handed operation
- High torque action
- Hard wearing, lightweight aluminium housing
- Twin hammer mechanism for increased torque and reduced vibration
- Handle design insulates against cold air and vibration

SPECIFICATION:		
Square drive	inch	1/2"
Bolt capacity	mm	M16
Free speed	rpm	6,800
Max torque (3 steps)	Nm	385/530/930
Max torque (3 steps)	ft-lb	285/390/685
Max reverse torque	Nm	950
Max reverse torque	ft-lb	700
Hammer mechanism	type	Twin hammer
Sound level *	dB	92.5
Vibration **	m/s <sup>2</sup>	22.45
Minimum hose size	inch	3/8"
Air inlet	inch	1/4"
Air consumption at 100% int.	l/min	162
Air consumption at 100% int.	cfm	5.3
Air consumption at 15% int.	l/min	24.3
Air consumption at 15% int.	cfm	0.8
Length	mm	183.1
Weight	kg	2.5

\* A weighted sound pressure level at work station with muffler in accordance with EN ISO 15744

\*\* Vibration value according to EN ISO 28927-2

Item ID: **ARWM12**







### AIR IMPACT WRENCH

- Three forward steps up to 1,790Nm
- Reversible for tightening or loosening
- Forward/reverse button for one handed operation
- High torque action
- Hard wearing, lightweight aluminium housing
- Twin hammer mechanism for increased torque and reduced vibration
- Handle design insulates against cold air and vibration

SPECIFICATION:		
Square drive	inch	3/4"
Bolt capacity	mm	M32
Free speed	rpm	5,000
Max torque (3 steps)	Nm	1,084/1,300/1,790
Max torque (3 steps)	ft-lb	800/960/1,320
Max reverse torque	Nm	1,830
Max reverse torque	ft-lb	1,349
Hammer mechanism	type	Twin hammer
Sound level *	dB	95.1
Vibration **	m/s <sup>2</sup>	11.88
Minimum hose size	inch	1/2"
Air inlet	inch	3/8"
Air consumption at 100% int.	l/min	181
Air consumption at 100% int.	cfm	6.4
Air consumption at 15% int.	l/min	27.2
Air consumption at 15% int.	cfm	1
Length	mm	218.8
Weight	kg	3.9

\* A weighted sound pressure level at work station in accordance with EN ISO 15744

\*\* Vibration value according to EN ISO 28927-2

Item ID: **ARWM34**



### COMPOSITE AIR IMPACT WRENCH

- Three forward steps up to 450Nm
- Reversible for tightening or loosening
- Forward/reverse button for one handed operation
- High torque action
- Extra lightweight composite housing
- Sound absorbent housing for noise reduction
- Twin hammer mechanism for increased torque and reduced vibration
- Handle design insulates against cold air and vibration

SPECIFICATION:		
Square drive	inch	3/8"
Bolt capacity	mm	M13
Free speed	rpm	9,000
Max torque (3 steps)	Nm	163/244/450
Max torque (3 steps)	ft-lb	120/180/331
Max reverse torque	Nm	470
Max reverse torque	ft-lb	346
Hammer mechanism	type	Twin hammer
Sound level *	dB	94
Vibration **	m/s <sup>2</sup>	3.8
Minimum hose size	inch	3/8"
Air inlet	inch	1/4"
Air consumption at 100% int.	l/min	128
Air consumption at 100% int.	cfm	4.5
Air consumption at 15% int.	l/min	19
Air consumption at 15% int.	cfm	0.7
Length	mm	161
Weight	kg	1.3

\* A weighted sound pressure level at work station in accordance with EN ISO 15744

\*\* Vibration value according to EN ISO 28927-2

Item ID: **ARWC38**





### COMPOSITE AIR IMPACT WRENCH

- Three forward steps up to 930Nm
- Reversible for tightening or loosening
- Forward/reverse button for one handed operation
- High torque action
- Extra lightweight composite housing
- Sound absorbent housing for noise reduction
- Twin hammer mechanism for increased torque, greater reliability and reduced vibration
- Handle design insulates against cold air and vibration

SPECIFICATION:		
Square drive	inch	1/2"
Bolt capacity	mm	M16
Free speed	rpm	6,800
Max torque (3 steps)	Nm	258/461/930
Max torque (3 steps)	ft-lb	190/340/685
Max reverse torque	Nm	960
Max reverse torque	ft-lb	708
Hammer mechanism	type	Twin hammer
Sound level *	dB	96
Vibration **	m/s <sup>2</sup>	3.6
Minimum hose size	inch	3/8"
Air inlet	inch	1/4"
Air consumption at 100% int.	l/min	144
Air consumption at 100% int.	cfm	5.1
Air consumption at 15% int.	l/min	22
Air consumption at 15% int.	cfm	0.8
Length	mm	186
Weight	kg	2

\* A weighted sound pressure level at work station in accordance with EN ISO 15744

\*\* Vibration value according to EN ISO 28927-2

Item ID: **ARWC12**



### COMPOSITE AIR IMPACT WRENCH

- Three forward steps up to 1,790Nm
- Reversible for tightening or loosening
- Forward/reverse button for one handed operation
- High torque action
- Extra lightweight composite housing
- Sound absorbent housing for noise reduction
- Twin hammer mechanism for increased torque and reduced vibration
- Handle design insulates against cold air and vibration

SPECIFICATION:		
Square drive	inch	3/4"
Bolt capacity	mm	M32
Free speed	rpm	6,000
Max torque (3 steps)	Nm	1,084/1,300/1,790
Max torque (3 steps)	ft-lb	800/960/1,320
Max reverse torque	Nm	1,830
Max reverse torque	ft-lb	1,349
Hammer mechanism	type	Twin hammer
Sound level *	dB	100
Vibration **	m/s <sup>2</sup>	19
Minimum hose size	inch	1/2"
Air inlet	inch	3/8"
Air consumption at 100% int.	l/min	195
Air consumption at 100% int.	cfm	6.9
Air consumption at 15% int.	l/min	29
Air consumption at 15% int.	cfm	1
Length	mm	218.8
Weight	kg	3.5

\* A weighted sound pressure level at work station in accordance with EN ISO 15744

\*\* Vibration value according to EN ISO 28927-2

Item ID: **ARWC34**





### STRAIGHT AIR IMPACT WRENCH

- Four forward steps up to 2,712Nm
- Extra lightweight composite housing
- Straight design with long anvil
- Reversible for tightening or loosening
- Forward/reverse button for one handed operation
- High torque action
- Sound absorbent housing for noise reduction
- Twin hammer mechanism for increased torque and reduced vibration
- Handle design insulates against cold air and vibration

SPECIFICATION:		
Square drive	inch	1"
Bolt capacity	mm	M36
Free speed	rpm	5,500
Max torque (4 steps)	Nm	976/1,300/1,735/2,712
Max torque (4 steps)	ft-lb	720/960/1,280/2,000
Max reverse torque	Nm	2,730
Max reverse torque	ft-lb	2,013
Hammer mechanism	type	Twin hammer
Sound level *	dB	104.5
Vibration **	m/s <sup>2</sup>	12.88
Minimum hose size	inch	3/4"
Air inlet	inch	1/2"
Air consumption at 100% int.	l/min	271
Air consumption at 100% int.	cfm	9.6
Air consumption at 15% int.	l/min	41
Air consumption at 15% int.	cfm	1.4
Length	mm	504.5
Weight	kg	8.1

\* A weighted sound pressure level at work station in accordance with EN ISO 15744

\*\* Vibration value according to EN ISO 28927-2

Item ID: **ARWM11S**



### AIR DRILL

- Air drill with 10mm chuck
- Pistol style for easier use
- Suitable for left or right handed use
- Simple to use thumb switch lever for switching between forward and reverse
- Quick chuck mechanism for fast and easy changing of drill bits
- Composite grip protects against cold air

SPECIFICATION:		
Chuck size	mm	10
Free speed	rpm	1,800
Minimum hose size	inch	3/8"
Air inlet	inch	1/4"
Sound level *	dB	88
Vibration **	m/s <sup>2</sup>	3
Air consumption at 100% int.	l/min	121
Air consumption at 100% int.	cfm	4
Air consumption at 15% int.	l/min	18
Air consumption at 15% int.	cfm	0.7
Length	mm	206.2
Weight	kg	1.2

\* A weighted sound pressure level at work station in accordance with EN ISO 15744

\*\* Vibration value according to EN ISO 28927-2

Item ID: **ARD10**





## AIR DRILL

- Air drill with 13mm chuck
- Pistol style for easier use
- Supplied with a support handle
- Suitable for left or right handed use
- Simple to use thumb switch lever for switching between forward and reverse
- Quick chuck mechanism for fast and easy changing of drill bits
- Composite grip protects against cold air

SPECIFICATION:		
Chuck size	mm	13
Free speed	rpm	450
Minimum hose size	inch	3/8"
Air inlet	inch	1/4"
Sound level *	dB	89
Vibration **	m/s <sup>2</sup>	2
Air consumption at 100% int.	l/min	140
Air consumption at 100% int.	cfm	5
Air consumption at 15% int.	l/min	21
Air consumption at 15% int.	cfm	0.8
Length	mm	249.5
Weight	kg	1.9

\* A weighted sound pressure level at work station in accordance with EN ISO 15744

\*\* Vibration value according to EN ISO 28927-2

Item ID: **ARD13**



## AIR SAW

- Air Saw with key hole saw function
- Small and easy to operate with low vibration and high cutting capacity
- Suitable for cutting steel plate, aluminium, copper, plastic, wood, etc.
- Compatible with standard saw blades
- Straight design with lever arm throttle for easier use
- Handle design insulates against cold air and vibration

SPECIFICATION:		
Stroke length	mm	10
Strokes per minute	bpm	9000
Cutting capacity – steel	mm	3
Cutting capacity – aluminium	mm	3
Cutting capacity – wood	mm	4
Sound level *	dB	84
Vibration **	m/s <sup>2</sup>	<2.4
Minimum hose size	inch	3/8"
Air inlet	inch	1/4"
Air consumption at 100% int.	l/min	31
Air consumption at 100% int.	cfm	1.08
Air consumption at 15% int.	l/min	4.7
Air consumption at 15% int.	cfm	0.2
Length	mm	245.1
Weight	kg	0.7

\* A weighted sound pressure level at work station in accordance with EN ISO 15744

\*\* Vibration value according to EN ISO 28927-2

Item ID: **ARS01**



**AIR SAW**

- Air Saw with key hole saw function
- Small and easy to operate with low vibration and high cutting capacity
- Suitable for cutting steel plate, aluminium, copper, plastic, wood, etc.
- Compatible with standard saw blades
- Straight design with lever arm throttle for easier use
- Handle design insulates against cold air and vibration

SPECIFICATION:		
Stroke length	mm	10
Strokes per minute	bpm	9000
Cutting capacity – steel	mm	3
Cutting capacity – aluminium	mm	3.4
Cutting capacity – wood	mm	4
Sound level *	dB	84.4
Vibration **	m/s <sup>2</sup>	5.26
Minimum hose size	inch	3/8"
Air inlet	inch	1/4"
Air consumption at 100% int.	l/min	22.94
Air consumption at 100% int.	cfm	0.81
Air consumption at 40% int.	l/min	9.18
Air consumption at 40% int.	cfm	0.32
Length	mm	170
Weight	kg	0.45

\* A weighted sound pressure level at work station in accordance with EN ISO 15744

\*\* Vibration value according to EN ISO 28927-2

Item ID: **ARS02**

**AIR CUT OFF TOOL**

- For use with 3" / 76mm cut off discs
- Hole size is 3/8" / 10mm
- Reversible direction for better control of spark direction
- Suitable for left or right handed users
- Ergonomically designed trigger with safety throttle and speed control
- Handle design insulates against cold air and vibration
- Air exhaust in the handle to protect against cold air
- Safety guard above the cut off disc

SPECIFICATION:		
For cutting discs	mm	76x10mm, 3"x3/8"
Speed	rpm	18000
Sound Level *	dB	97.6
Vibration **	m/s <sup>2</sup>	2.3
Minimum hose size	inch	3/8"
Connection thread	inch	1/4"
Air consumption at 100% int.	l/min	113
Air consumption at 100% int.	cfm	4
Air consumption at 40% int.	l/min	45
Air consumption at 40% int.	cfm	1.6
Weight	kg	0.9

\* A weighted sound pressure level at work station in accordance with EN ISO 15744

\*\* Vibration value according to EN ISO 28927-2

Item ID: **ARC80**

DEVELOPED TO **EXCEED**  
THE DEMANDS OF A  
**PROFESSIONAL**  
**WORKSHOP**







## AIR DIE GRINDER STRAIGHT

- Composite grip for added comfort
- Air exhaust in the handle to protect against cold air
- Silencer for noise reduction and quieter operation
- Safety throttle lever to avoid accidental operation

SPECIFICATION:		
Angle		straight
Collet	mm	6
Free speed	rpm	25,000
Sound level *	dB(A)	82
Vibration **	m/s <sup>2</sup>	5
Minimum hose size	inch	3/8
Air inlet	inch	1/4
Air consumption at 100% int.	l/min	113
Air consumption at 15% int.	l/min	16.9
Air consumption at 100% int.	cfm	4
Air consumption at 15% int.	cfm	0.6
Length	mm	161
Weight	g	400

\* A weighted sound pressure level at work station in accordance with EN ISO 15744

\*\* Vibration value according to EN ISO 28927-2

Item ID: **ARG01**



## AIR DIE GRINDER ANGLED

- Angled at 90° for use from above
- Air exhaust in the handle to protect against cold air
- Silencer for noise reduction and quieter operation
- Safety throttle lever to avoid accidental operation

SPECIFICATION:		
Angle		90°
Collet	mm	6
Free speed	rpm	25,000
Sound level *	dB(A)	82
Vibration **	m/s <sup>2</sup>	5
Minimum hose size	inch	3/8
Air inlet	inch	1/4
Air consumption at 100% int.	l/min	113
Air consumption at 15% int.	l/min	16.9
Air consumption at 100% int.	cfm	4
Air consumption at 15% int.	cfm	0.6
Length	mm	165
Weight	g	400

\* A weighted sound pressure level at work station in accordance with EN ISO 15744

\*\* Vibration value according to EN ISO 28927-2

Item ID: **ARG02**





\*Grinding wheel not included

### AIR ANGLE GRINDER

- For use with 5" (125mm) grinding wheels
- Fully adjustable guard with 9 different positions
- Side handle dampens against vibration for more comfortable use
- M14 flange washer and spindle locking for easier change of wheels
- Ergonomically designed trigger with safety throttle and speed control
- Handle design insulates against cold air and vibration

SPECIFICATION:		
For grinding disc	mm	125 x 22
Spindle thread	mm	M14
Rotating speed	rpm	12,000
Sound level *	dB	90.2
Sound power level	dB	101.2
Vibration **	m/s <sup>2</sup>	5.7
Measurement uncertainty (Standard)	m/s <sup>2</sup>	1.06
Min. hose size	inch	3/8"
Air inlet	inch	1/4"
Air consumption at 100% int.	l/min	113
Air consumption at 50% int.	l/min	56.5
Air consumption at 100% int.	cfm	4
Air consumption at 50% int.	cfm	2
Power	W	670
Weight	kg	2

\* A weighted sound pressure level at work station in accordance with EN ISO 15744

\*\* Vibration value according to EN ISO 28927-2

Item ID: **ARAG125**



### AIR BELT SANDER

- For use with 6 and 10mm wide abrasive belts
- Fully adjustable grinding arm with 360° rotation
- Suitable for grinding metal, plastic or wood
- Ergonomically designed trigger with safety throttle and speed control
- Handle design insulates against cold air and vibration
- Supplied with grinding arms for 6mm and 10mm wide 330mm length belts
- 4 belts included

SPECIFICATION:		
For sanding belt	mm	6 x 330, 10 x 330
Free speed	rpm	20,000
Sound pressure level *	dB	85.5
Sound power level	dB	96.5
Vibration **	m/s <sup>2</sup>	0.66
Measurement uncertainty (Standard)	m/s <sup>2</sup>	0.56
Min. hose size	inch	3/8"
Air inlet	inch	1/4"
Air consumption at 100% int.	l/min	119
Air consumption at 50% int.	l/min	59.5
Air consumption at 100% int.	cfm	4.2
Air consumption at 50% int.	cfm	2.1
Length	mm	331
Weight	kg	0.85

\* A weighted sound pressure level at work station in accordance with EN ISO 15744

\*\* Vibration value according to EN ISO 28927-2

Item ID: **ARBS10**





### AIR NEEDLE SCALER

- For cleaning and descaling work
- Straight design with lever arm throttle
- Air exhaust in the handle to protect against cold air
- Supplied complete with needle equipment
- For use with 3mm diameter, 126mm length needles

SPECIFICATION:		
Stroke speed	bpm	4000
No. of needles	pcs	12
Needle stroke	mm	24
Needle diameter x length (AXB)	mm	3 x 126
Sound pressure level *	dB	88.7
Vibration **	m/s <sup>2</sup>	3.8
Min. hose size	inch	3/8"
Air inlet	inch	1/4"
Air consumption at 100% int.	l/min	170
Air consumption at 20% int.	l/min	34
Air consumption at 100% int.	cfm	6
Air consumption at 20% int.	cfm	1.2
Total length	mm	310
Weight	kg	1.14

\* A weighted sound pressure level at work station in accordance with EN ISO 15744

\*\* Vibration value according to EN ISO 28927-2

Item ID: **ARN12**



### AIR RIVET GUN

- For use with 2.4, 3.0, 3.2, 4.0, 4.8 or 5.0mm rivets
- For use with aluminium, copper, steel and stainless steel blind rivets
- Ergonomically designed to reduce fatigue from vibration
- Patented rivet size hole gauge to ensure the correct size rivet and nose piece are selected
- Spent mandrel container automatically collects spent mandrels
- Complete with hanging bracket for easier storage

SPECIFICATION:		
Traction force	N	9000
Compressed air pressure stroke	mm	16
Sound pressure level *	dB	85.8
Sound power level	dB	96.8
Vibration **	m/s <sup>2</sup>	2.5
Air inlet	inch	1/4" PT-19
Min. hose size	inch	3/8"
Working Temperature	°C	0-40
Air consumption at 100% int.	l/rivet	2.1
Weight	g	1710

\* A weighted sound pressure level at work station in accordance with EN ISO 15744

\*\* Vibration value according to EN ISO 28927-2

Item ID: **ARRG80**



### SERVICE KITS FOR AIR RIVET GUN

ITEM ID:	Description
ARRG80-1RK	Nosepieces (4 Pieces)
ARRG80-3RK	Jaw Case Assembly



**AIR ENGRAVING PEN**

- With hardened metal stylus
- Suitable for use on plastic as well as metals including hardened steel
- Steel body with knurled grip and on/off control
- Supplied with 1.5 meter connection cable with 360° swivelling air inlet

SPECIFICATION:		
Working pressure	bar	6.2
Stroke speed	bpm	13,000
Sound Level *	dB	78
Sound power level	dB	90
Vibration **	m/s <sup>2</sup>	2.5
Air inlet	inch	1/4"
Air consumption at 100% int.	l/min	30
Air consumption at 50% int.	l/min	15
Air consumption at 100% int.	cfm	1.1
Air consumption at 50% int.	cfm	0.6
Weight	kg	0.22

\* A weighted sound pressure level at work station in accordance with EN ISO 15744

\*\* Vibration value according to EN ISO 28927-2

Item ID: **AREP25**

**AIR BLOW GUN**

- Pistol grip with 100mm nozzle and 1/4" air inlet
- Suitable for left or right handed use
- Low effort trigger mechanism for easier operation
- Metal thread insert for reliability
- Hole in the handle for hanging or for use with a fall protection wire

SPECIFICATION:		
Nozzle length	mm	100
Air inlet	inch	1/4"
Length	mm	212
Weight	g	106

Item ID: **ARB01**

**AIR BLOW GUN**

- Pistol grip with 270mm nozzle and 1/4" air inlet
- Suitable for left or right handed use
- Low effort trigger mechanism for easier operation
- Metal thread insert for reliability
- Hole in the handle for hanging or for use with a fall protection wire

SPECIFICATION:		
Nozzle length	mm	270
Air inlet	inch	1/4"
Length	mm	360
Weight	g	130

Item ID: **ARB02**

**AIR BLOW GUN**

- Relief slot conforms to OSHA - Occupational Safety and Health Administration safety standards
- Pistol grip with 100mm nozzle and 1/4" air inlet
- Suitable for left or right handed use
- Low effort trigger mechanism for easier operation
- Metal thread insert for reliability
- Hole in the handle for hanging or for use with a fall protection wire

SPECIFICATION:		
Nozzle length	mm	100
Air inlet	inch	1/4"
Length	mm	212
Weight	g	160

Item ID: **ARB03**





	Page No.		Page No.		Page No.
1 Watt Led Torch	467	Aluminium Spirit Levels	433	Brackets For Middle Boxes	99
125° Hook Tool	437	Aluminium Spirit Level	433	Brackets For Top Boxes	99
1-3 Watt Led Torch	467	Aluminium Try Squares	431	Brake Cylinder Honing Tool	442
2 Arm Quick Action Universal Puller Set	452	Angled Ratcheting Bits Driver Set	353	Brake Pin Punch	442
2 Arm Quick Action Universal Pullers	451	Angled Ratcheting Bits Driver Set	145	Brake Spring Washer Tool	442
2 Arm Universal Puller Set	452	Angled Ratcheting Bits Driver Set	354	Brick Layers Masonry Hammer	474
2 Arm Universal Pullers	450	Angular Gauge	279	C Clamp Power Grip Pliers	398
2 In 1 Magnetic Pick Up And Pen	466	Anti Slip Combination Spanner Set	137	C Clamp Power Grip Pliers	399
3 Arm Quick Action Universal Pullers	451	Anti Slip Combination Spanner Set	172	Cable Tie Gun	458
3 Arm Universal Pullers	451	Anti Slip Combination Spanner Set	187	Canilever Tool Box	97
3 In 1 Inspection Tool	466	Anti Slip Combination Spanner Set	293	Carbon Fibre Claw Hammer	474
3 To 5 Watt Led Torch	467	Anti Slip Combination Spanner Set	294	Carpenters Pliers	382
35° Hook Tool	437	Anti Slip Combination Spanners	293	Carrying Case	96
4 Drawer Module	108	Assorted Key Set	374	Centre Punches	474
4 Piece Divider Set	99	Automatic Centre Punch	474	Chain Pipe Cutter	460
4" Gear Puller	450	Automotive Socket Set	154	Chain Pipe Wrench	461
6Mm/7Mm Hose Clip Driver	438	Automotive Socket Set	444	Chrome Molybdenum Ball Point Hex Keys	363
7" Gear Puller	450	Awl	436	Chrome Molybdenum Ball Point Hex Keys	364
72 Teeth Ratchets	228	Ball Joint Separator	443	Circlip Plier Set	148
7Mm Hose Clip Driver	438	Ball Joint Separators	443	Circlip Plier Set	149
8Mm Hose Clip Driver	438	Ball Pein Hammers	473	Circlip Plier Set	394
9 Series - Tool Cabinet	92	Ball Point Hex Key Set	366	Circlip Plier Set	391
9" Crimping Plier And Wire Stripper	456	Ball Point Hex Key Set	367	Circlip Pliers	392
90° Hook Tool	436	Ball Point Hex Keys	363	Circlip Pliers	393
90° Hook Tool	437	Ball Point Tx Key Set	372	Circuit Tester	458
Adaptors	234	Ball Point Tx Key Set	373	Clamping Power Grip Pliers	400
Adjustable Tap Chuck	422	Ball Point Tx Keys	371	Claw Hammer With Magnetic Nail Holder	474
Adjustable Wrench Service Kit	314	Barn Style Tool Box	97	Claw Hammers	473
Adjustable Wrench Service Kit	315	Base Cabinet Module	108	Claw Pick Up Tool	465
Adjustable Wrench Service Kits	314	Base Module	108	Clip Rail Set	122
Adjustable Wrench Set	141	Base Squares	430	Coil Spring Compression Set	443
Adjustable Wrench Set	175	Bent Long Nose Pliers	384	Cold Chisels	475
Adjustable Wrench Set	315	Bicycle Tool Kit	374	Combination Pliers	383
Adjustable Wrenches	314	Bicycle Tool Kit	445	Combination Spanner And File Set	174
Af Combination Spanners	287	Bi-Directional Torque Wrenches	274	Combination Spanner Set	137
Af Ratcheting Combination Spanners	297	Bi-Directional Torque Wrenches	276	Combination Spanner Set	138
Air Angle Grinder	493	Bi-Flex Wrench	308	Combination Spanner Set	173,288
Air Belt Sander	493	Bit Adaptors For Sockets	345	Combination Spanner Set	173
Air Blow Gun	495	Bit Holders	344	Combination Spanner Set	187
Air Cut Off Tool	491	Bit Set	347	Combination Spanner Set	287
Air Die Grinder Angled	492	Bit Set	349	Combination Spanner Set	288
Air Die Grinder Straight	492	Bit Socket Set	127	Combination Spanner Set	289
Air Drill	489	Bit Socket Set	128	Combination Spanner Set	290
Air Drill	490	Bit Socket Set	205	Combination Spanner Set	291
Air Engraving Pen	495	Bits Driver	351	Combination Spanner Set	292
Air Impact Wrench	486	Bits Driver	352	Combination Spanner Set	293
Air Impact Wrench	487	Bits Driver Extension	344	Combination Square	431
Air Impact Wrench Set	159	Bits Driver Extension	345	Composite Air Impact Wrench	487
Air Impact Wrench Set	485	Bits Driver Set	352	Composite Air Impact Wrench	488
Air Needle Scaler	494	Blank Key	103	Construction Impact Bit Set	348
Air Ratchet	484	Body Working Dollies	447	Corner Cabinet	109
Air Rivet Gun	494	Body Working Hammer	446	Corner Shelving Module	110
Air Saw	490	Body Working Hammer	447	Coupler Adaptors	234
Air Saw	491	Bodywork Hammer Set	155	Coupler Adaptors	345
Alligator Adjustable Wrench	315	Bodywork Hammer Set	447	Crimping Plier And Wire Stripper	456
Aluminium Pipe Reamers	460	Bolt Cutter Replacement Jaws	380		
		Bolt Cutters	380		



	Page No.		Page No.		Page No.
Crimping Plier Set	156	Double Ring Spanner Set	303	Flaring Tool Set	442
Crimping Plier Set	157	Double Ring Spanner Set	304	Flat (Slotted) Bits	336
Crimping Plier Set	457	Double Ring Spanners	301	Flat (Slotted) Blade Insulated Screwdrivers	404
Crow Foot Wrench Set	207,247	Drain Plug Keys	441	Flat Bit Sockets	240
Crow Foot Wrenches	247	Drawer Modules	111	Flat Nose Pliers	384
Cutting Tool Set	151	Drill Bit Set	421	Flex Handle Service Kits	230,232
Cutting Tool Set	416	End Nippers	381	Flex Handle Service Kits	232
Cylinder Leakage Tester	441	Engine Cylinder Honing Tool	441	Flex Handles	232
Dead Blow Hammers	447	Engineers Style Hammer	473	Flex Head Adaptor	233
Deburring Tool	461	Ev - Tool Cabinet	90	Flex Head Ratchets	229
Deep 6 Point Impact Sockets	258	Eva Extra Wide Roller Cabinet Tool Kit	48-49	Flexible Head Ratchet Spanner Set	139
Deep 6 Point Impact Sockets	261	Eva Portable Tool Kit	60	Flexible Head Ratchet Spanner Set	300
Deep 6 Point Impact Sockets	262	Eva Portable Tool Kit	61	Flexible Head Ratchet Spanners	300
Deep 6 Point Impact Sockets	266	Eva Roller Cabinet Tool Kit	50	Flexible Led Light	468
Deep 6 Point Impact Sockets	443	Eva Roller Cabinet Tool Kit	51	Flexible Light	468
Deep 6 Point Metric Impact Socket	268	Eva Roller Cabinet Tool Kit	52	Flexible Spinner Handle	231
Deep Af Sockets	240	Eva Roller Cabinet Tool Kit	53	Flip Reverse Ratchets	229
Deep Af Sockets	245	Eva Stack System Tool Kit	34-35	Floor Standing Cabinet	109
Deep Impact Socket Set	224	Eva Stack System Tool Kit	36-37	Flush Cut Pliers	381
Deep Metric 12 Point Sockets	250	Eva Stack System Tool Kit	38-39	Folding Mini Utility Knife	419
Deep Metric 6 Point Sockets	250	Eva Top Box Tool Kit	56	Folding Universal Utility Knife	419
Deep Metric Sockets	239	Extendable Ratchet	230	Full Height Cabinet	109
Deep Metric Sockets	244	Extendable Ratchet Set	131	Fully Ground Drill Bit	420
Deep Stainless Steel Sockets	251	Extendable Ratchet Set	217	Fully Ground Drill Bit Set	152
Deep Thinwall Metric Impact Sockets	268	Extension Bars	232	Fully Ground Drill Bit Set	421
Dial Indicator With Measuring Stand	428	Extension Bars Set	131	Gasket Scraper	436
Die Chuck	422	Extension Bars Set	166	General Tool Set	124
Die Handle	422	Extension Bars Set	233	General Tool Set	163
Digital Bi-Directional Torque Wrench	273	Extra Large Module	106	General Tool Set	164
Digital Bi-Directional Torque Wrench	275	Extra Long 6 Point Metric Impact Socket	267	Grease Gun	450
Digital Caliper	428	Extra Long 6 Point Metric Impact Socket	268	Groove Joint Pliers	385
Digital Multimeter	458	Extra Long Combination Spanner Set	296	Gun Saw Set	417
Digital Multimeter	459	Extra Long Combination Spanners	295	Hacksaw & Knife Set	417
Digital Torque Tester	281	Extra Long Combination Spanners	295	Hacksaw Blade Holder	417
Digital Torque Testers	281	Extra Long Double Ring Spanner Set	139	Hand File - Flat	425
Disc Brake Pad Puller	442	Extra Long Double Ring Spanner Set	175	Hand File - Half Round	425
Double Ended Blades	325	Extra Long Double Ring Spanner Set	302	Hand File - Round	425
Double Ended Flat (Slotted) Bit	336	Extra Long Double Ring Spanner Set	303	Hand File - Square	426
Double Ended Mini Screwdriver Blades	319	Extra Long Double Ring Spanners	302	Hand File - Triangular	425
Double Ended Ph Bits	336	Extra Long Hex Key Set	366	Hand File Set	153
Double Ended Pz Bits	338	Extra Long Hex Keys	363	Hand File Set	191
Double Ended Tx Bits	339	Extra Wide Roller Cabinet Tool Kit	40-41	Hand File Set	426
Double Ended Wheel Nut Sockets	444	Extra Wide Roller Cabinet Tool Kit	42-43	Hand Rivet Gun	462
Double Flex Wrench Set	140	Extra Wide Stack System	82	Hand Rivet Gun	463
Double Flex Wrench Set	175	Extra Wide Tool Cabinet	93	Hand Rivet Gun With Swivel Head	463
Double Flex Wrench Set	188	Extra Wide Tool Cabinet	94	Handle For Interchangeable Blades	406
Double Flex Wrench Set	307	Extra Wide Top Box	85	Handle For Tool Cabinets	102
Double Flex Wrenches	307	Extractor Set	156	Handles For Top & Middle Boxes	102
Double Open Ended Spanner Set	140	Extractor Set	454	Heavy Duty Cable Cutter	379
Double Open Ended Spanner Set	305	F Clamps	471	Heavy Duty Cable Cutters	379
Double Open Ended Spanner Set	306	F Clamps	472	Heavy Duty Cutters	380
Double Open Ended Spanners	305	Fast Action Clamps	472	Heavy Duty Insulated Side Cutting Plier	409
Double Ring Spanner Set	139	Feeler Gauges	429	Heavy Duty Oil Filter Removal Tool	440
Double Ring Spanner Set	175	Five Lock Set	103	Heavy Duty Ratchet	230
Double Ring Spanner Set	302	Flare Nut Wrenches	308	Heavy Duty Ratchet Head	230
		Flaring Tool Set	155		



	Page No.		Page No.		Page No.
Heavy Duty Ratchets	229	Hose Clamp Set	154	Insulated Side Cutting Plier	409
Heavy Duty Utility Knife	419	Hose Clamp Set	438	Insulated Wire Stripping Pliers	410
Hex & Tx Bit Socket Set	130	Hose Clamps	438	Interchangeable Blades	406
Hex & Tx Bit Socket Set	212	Impact Accessories	236	Intricate Cutting Scissors	415
Hex And Tx Wrench Set	147	Impact Adaptor	344	Intricate Cutting Scissors	416
Hex And Tx Wrench Set	370	Impact Bit Set	145	Ipr - Tamper Proof Bit Set	346
Hex Bit Impact Sockets	259	Impact Bit Set	180	Kick Plates	111
Hex Bit Impact Sockets	263	Impact Bit Set	347	Kneeling Pad	468
Hex Bit Impact Sockets	267	Impact Bit Set	348	Kneeling Pad	469
Hex Bit Socket Set	129	Impact Bit Set	350	Large Capacity Sv Top Box	85
Hex Bit Socket Set	130	Impact Bits Set	356	Large Capacity Top Box	84
Hex Bit Socket Set	207	Impact Driver Bits	358	Large Magnetic Bits Tray	470
Hex Bit Socket Set	211	Impact Driver Set	135	Large Module	106
Hex Bit Socket Set	212	Impact Driver Set	356	Lazy Tongue Rivet Gun	463
Hex Bit Socket Set	214	Impact Driver Set	359	Led Head Lamp	467
Hex Bit Sockets	246	Impact Driver Set	135	Led Light Bar	116
Hex Bit Sockets	251	Impact Driver Set	358	Led Torch	467
Hex Bit Sockets	252	Impact Magnetic Bits Holder	344	Led Work Light	116
Hex Bit Sockets	255	Impact Nut Setter Set	348	Long Arm Flexible Ratchet	229
Hex Bits	341	Impact Nut Setter Set	351	Long Arm Ratchet	229
Hex Bits	342	Impact Nut Setters	344	Long Blade Straight Cut Tin Snips	414
Hex Bits	343	Impact Screw Extractors	452	Long Double Ring Spanner Set	188
Hex Impact Bit Socket Set	134	Impact Socket Accessory Set	133	Long Double Ring Spanner Set	303
Hex Impact Bit Socket Set	223	Impact Socket Accessory Set	221	Long Handled Nutsert Gun	463
Hex Impact Screwdriver Bit	342	Impact Socket Set	132	Long Handled Rivet Gun	463
Hex Key Set	365	Impact Socket Set	133	Long Hex Bit Sockets	252
Hex Key Set	367	Impact Socket Set	134	Long Nose Pliers	383
Hex Key Set	368	Impact Socket Set	135	Long Reach Combination Spanner Set	138
Hex Key Set	369	Impact Socket Set	170	Long Reach Combination Spanner Set	187
Hex Keys	362	Impact Socket Set	171	Long Reach Combination Spanner Set	295
Hex Screwdrivers	324	Impact Socket Set	221	Long Reach Flexible Bits Driver	351
Hex Screwdrivers	325	Impact Socket Set	222	Long Reach Pliers	385
Hex, Tx And Screwdriver Key Set	180	Impact Socket Set	223	Long T-Bar Socket Set	155
Hex, Tx And Screwdriver Key Set	370	Impact Tx Bit Set	348	Long T-Bar Socket Set	245
High Leverage Left/Straight Cut Tin Snips	415	Individual Dies	422	Long Tx Bit Sockets	253
High Leverage Right/Straight Cut Tin Snips	415	Individual Taps	422	Lump Hammer	473
High Leverage Straight Cut Tin Snips	415	Industrial Quality Workbenches	112	Machine Table Clamp Locking Pliers	400
Hinge Adjustment Wrench	472	Insert Adaptor Set	235	Magnetic Aluminium Spirit Levels	433
Hinge Adjustment Wrenches	472	Insert Adaptors	234	Magnetic Angle Blocks	470
Hobby Knife Set	418	Insert Ratchet Adaptors	277	Magnetic Bits Tray	469
Hobby Knife With 18Mm Blade	418	Inspection Set	158	Magnetic Bracelet	469
Hobby Knife With 9Mm Blade	417	Inspection Set	466	Magnetic Charger	328
Hobby Knife With 9Mm Blade	418	Insulated Combination Pliers	409	Magnetic Plastic Bowl	470
Hook And Pick Set	153	Insulated Long Nose Pliers	410	Magnetic Side Shelf	99
Hook And Pick Set	437	Insulated Plier Set	151	Magnetic Side Shelf	100
Hook And Pick Set	438	Insulated Plier Set	183	Magnetic Tool Rail	102
Hook And Pin Wrench Set	141	Insulated Plier Set	190	Magnifying Glass	468
Hook And Pin Wrench Set	311	Insulated Plier Set	410	Measuring Tapes	432
Hook On Bits Set	346	Insulated Plier Set	411	Measuring Tool Set	153
Hook On Can Holder	115	Insulated Screwdriver And Plier Set	411	Measuring Tool Set	183
Hook On Impact Bits Set	346	Insulated Screwdriver Set	150	Measuring Tool Set	430
Hook On Tool Holder	115	Insulated Screwdriver Set	151	Mechanics Creeper	469
Hook On Trays	115	Insulated Screwdriver Set	183	Mechanics Socket Set	209
Hook Wrenches	311	Insulated Screwdriver Set	190	Mechanics Starter Kit	54
Hooks For Side Plates And Panels	101, 116	Insulated Screwdriver Set	406	Mechanics Starter Kit	55
		Insulated Screwdriver Set	407		
		Insulated Screwdriver Set	408		

	Page No.		Page No.		Page No.
Mechanics Stool	469	Off Set Straight/Right Tin Snips	414	Power Through Screwdriver Set	189
Medium Module	107	Oil Filter Removal Tool	440	Power Through Screwdriver Set	326
Mega Bite Cable Cutters	379	Oil Filter Remover Plier	396	Power Through Screwdriver Set	327
Mega Bite Side Cutters	378	Oil Filter Remover Plier	440	Power Through Screwdrivers - Flat Tip	326
Mega Master Tool Kit	20-21	Oil Service Set	154	Power Through Screwdrivers - Ph Tip	326
Mega Master Tool Kit	22-23	Oil Service Set	441	Pre Set Torque Wrench Set	136
Metric Combination Spanners	286	Open Ended Insert Spanner	278	Pre Set Torque Wrench Set	187
Micrometer	428	Open Ended Insert Spanner	279	Pre Set Torque Wrenches	275
Middle Box	86	Open Ended Slogging Wrenches	312	Professional Quality Hacksaw	416
Midget Combination Spanner Set	137	Parallel Pin Punch Set	476	Protective Glasses	480
Midget Combination Spanner Set	295	Parallel Pin Punches	474	Protective Glasses	481
Mini Air Impact Wrench	485	Ph Bit Sockets	241	Protective Wing Cover	446
Mini Bent Nose Plier	390	Ph Bits	337	Pry Bar Set	156
Mini Bits Ratchet	228	Ph Blade Insulated Screwdrivers	404	Pry Bar Set	184
Mini Bits Ratchet	345	Ph Impact Screwdriver Bit	337	Pry Bar Set	455
Mini End Cutter	389	Ph2G Bits	337	Pry Bars	455
Mini Flat Nose Plier	390	Ph2G Impact Screwdriver Bit	338	P-Series Insert Torque Wrenches	277
Mini Hacksaw	417	Pin Wrenches	311	P-Series Torque Wrench Set	136
Mini Hacksaw	417	Pipe Cutter	459	P-Series Torque Wrench Set	276
Mini Long Nose Plier	389	Pipe Cutter	460	P-Series Torque Wrenches	273
Mini Needle Nose Plier	390	Pipe Cutter Set	157	P-Series Torque Wrenches	275
Mini Palm Ratchet	228	Pipe Cutter Set	461	P-Series Torque Wrenches	276
Mini Pliers & Screwdriver Set	143	Pipe Reamer	460	Punch And Chisel Set	158
Mini Pliers & Screwdriver Set	319	Pipe Wrenches	389	Punch And Chisel Set	184
Mini Pliers & Screwdriver Set	390	Piston Ring Compressor	441	Punch And Chisel Set	191
Mini Ratchet	228	Plastic Try Squares	431	Punch And Chisel Set	475
Mini Round Nose Plier	390	Plier & Wrench Set	148	Punch And Chisel Set	476
Mini Screwdriver Set	319	Plier & Wrench Set	181	Pz Bit Sockets	241
Mini Screwdriver Set	320	Plier & Wrench Set	387	Pz Bits	338
Mini Screwdrivers - Flat Tip	318	Plier & Wrench Set	388	Pz Blade Insulated Screwdrivers	405
Mini Screwdrivers - Hex Tip	318	Plier And Hammer Set	163	Pz Impact Screwdriver Bit	339
Mini Screwdrivers - Ph Tip	318	Plier Set	147	Quick Chuck Bits Driver Set	179
Mini Screwdrivers - Tx Tip	318	Plier Set	148	Quick Chuck Bits Driver Set	356
Mini Side Cutter	389	Plier Set	181	Quick Clamps	471
Mini Starter Kit	62	Plier Set	182	Quick Set Water Pump Pliers	386
Mini T-Handle Screwdrivers - Tx Tip	320	Plier Set	190	Quick Set Water Pump Pliers	385
Mini Tool Box	96	Plier Set	386	Quick Wrench Set	140
Mini Tx Screwdriver Set	319	Plier Set	387	Quick Wrench Set	310
Mini Tx T-Handle Screwdriver Set	320	Plier Set	388	Quick Wrenches	310
Mobile Trolleys	110	Plus/Minus Blade Insulated Screwdrivers	405	Racking System Corner Shelf	111
Monster Mega Master Tool Kit	16-17	Pocket Sized Double Ring Spanner	302	Racking System Shelves	111
Monster Mega Master Tool Kit	18-19	Portable Service Case	96	Racking System Sliding Shelves	111
Multi Drive Spanner Repair Kits	309	Portable Tool Kit	58	Racking Tool Kit	69
Needle File	424	Portable Tool Kit	59	Racking Tool Kit	71
Needle File Set	152	Portable Tool Kit	60	Racking Tool Kit	73
Needle File Set	425	Portable Tool Kit	62	Racking Tool Kit	75
Non Slip Mat	98	Portable Tool Kit	63	Racking Tool Kit	77
Nut And T Handle Driver Set	181	Portable Tool Panels	117	Ratchet & Accessories Set	128
Nut Driver Set	143	Portable Work Station With Tools	117	Ratchet & Accessories Set	131
Nut Driver Set	327	Power Bar	230	Ratchet & Accessories Set	167
Nut Drivers	327	Power Grip Plier Set	149	Ratchet & Accessories Set	210
Nut Setters	343	Power Grip Plier Set	182	Ratchet & Accessories Set	216
Nut Splitter Set	453	Power Grip Plier Set	397	Ratchet & Accessories Set	217
Nutsert Gun	463	Power Grip Pliers	396	Ratchet Action Crimping Plier	456
Nutsert Gun Set	157	Power Through Screwdriver Set	143	Ratchet Head & Bits Holder	228
Nutsert Gun Set	464	Power Through Screwdriver Set	179	Ratchet Head & Bits Holder	345
Off Set Straight/Left Tin Snips	414			Ratchet Service Kits	230



	Page No.		Page No.		Page No.
Ratchet Spanner Set	138	Rob Bits	343	Self Locking Pliers	391
Ratchet Spanner Set	139	Rob Blade Insulated Screwdriver	405	Service Kits For Air Rivet Gun	494
Ratchet Spanner Set	174	Rob Impact Screwdriver Bit	343	Service Kits For Nut Splitters	453
Ratchet Spanner Set	188	Roller Cabinet Cover	98	Service Kits For Stud Extractors	453
Ratchet Spanner Set	297	Roller Cabinet Tool Kit	44-45	Service Tool Set	125
Ratchet Spanner Set	298	Roller Cabinet Tool Kit	46	Sheet Metal Power Grip Pliers	400
Ratchet Spanner Set	299	Roller Cabinet Tool Kit	47	Shelving & Drawer Unit	110
Ratchet Spanner Set	300	Rotating Pipe Cutters	460	Shelving Unit Module	110
Ratcheting Bits Driver Set	352	Rotating Spinner Handle	231	Shock Absorbing Claw Hammer	473
Ratcheting Bits Driver Set	353	Round Nose Pliers	384	Side Cabinet	95
Ratcheting Combination Spanner	296	S Shaped Hook Tool	436	Side Cabinet Transport Trolley	103
Ratcheting Combination Spanners	298	Safety Glasses	479	Side Cupboard	95
Ratcheting Multi Drive Ring Spanner Set	308	Safety Glasses	480	Side Plate	100
Ratcheting Multi Drive Ring Spanners	308	Safety Hand Grip	475	Side Plate	101
Ratcheting Offset Ring Spanner Set	140	Safety Utility Knife	419	Side Table And Paper Roll Holder	100
Ratcheting Offset Ring Spanner Set	309	Safety Wire	477	Side Table For Mounting A Vice	100
Ratcheting Offset Ring Spanners	309	Safety Wire	478	Single Drawer Module	108
Ratcheting Offset Tx-E Wrench	309	Scissors	415	Sliding Bevel	431
Ratcheting Podger Wrenches	310	Scraper Set	154	Sliding T-Bars	235
Regular 6 Point Impact Sockets	258	Scraper Set	437	Small Module	107
Regular 6 Point Impact Sockets	259	Screw Clamps	471	Socket & Bits Set	143
Regular 6 Point Impact Sockets	260	Screw Extractor Set	452	Socket & Bits Set	144
Regular 6 Point Impact Sockets	265	Screw Extractor Set	453	Socket & Bits Set	145
Regular 6 Point Impact Sockets	267	Screw Extractors	452	Socket & Bits Set	354
Regular 6 Point Metric Impact Sockets	269	Screwdriver & Hex Key Set	178	Socket & Bits Set	355
Regular Af Sockets	238	Screwdriver And Hex Key Set	179	Socket & Tool Set	202
Regular Af Sockets	239	Screwdriver Bit Set	144	Socket & Tool Set	203
Regular Af Sockets	243	Screwdriver Bit Set	145	Socket & Tool Set	210
Regular Af Sockets	249	Screwdriver Bit Set	354	Socket & Tool Set	219
Regular Af Sockets	255	Screwdriver Bit Set	355	Socket Adaptor Set	132
Regular Impact Socket Set	224	Screwdriver Blade Set	142	Socket Adaptor Set	234
Regular Metric 12 Point Sockets	248	Screwdriver Blade Set	325	Socket And Spanner Set	173
Regular Metric 6 Point Sockets	248	Screwdriver Rack	188	Socket Clip Rail Set	101
Regular Metric Sockets	237	Screwdriver Rack	330	Socket Clip Rails	101
Regular Metric Sockets	238	Screwdriver Set	141	Socket Clips	101
Regular Metric Sockets	242	Screwdriver Set	142	Socket Set	125
Regular Metric Sockets	248	Screwdriver Set	176	Socket Set	126
Regular Metric Sockets	254	Screwdriver Set	177	Socket Set	127
Regular Metric Sockets	255	Screwdriver Set	328	Socket Set	128
Replacement 6/7Mm Socket	438	Screwdriver Set	329	Socket Set	129
Replacement Combination Locks	104	Screwdriver Set	330	Socket Set	132
Replacement Key Locks	104	Screwdriver Set	331	Socket Set	165
Replacement Pipe Cutter Chain	460	Screwdriver Set	332	Socket Set	166
Replacement Pins	311	Screwdriver Set	333	Socket Set	167
Retaining Rings & Pins	237	Screwdriver Set	408	Socket Set	168
Retaining Rings & Pins	236	Screwdriver Set With Pocket Clips	321	Socket Set	169
Ribe & Xzn Bit Socket Set	131	Screwdriver With Pocket Clip	320	Socket Set	170
Ribe & Xzn Bit Socket Set	213	Screwdriver With Pocket Clip	321	Socket Set	194
Ribe Bit Sockets	253	Screwdrivers - Flat Tip	322	Socket Set	195
Ring Ended Insert Spanner	277	Screwdrivers - Ph Tip	323	Socket Set	196
Ring Ended Insert Spanner	278	Screwdrivers - Pz Tip	323	Socket Set	197
Ring Type Slogging Wrenches	312	Screwdrivers - Rob Tip	325	Socket Set	198
Rivet Gun Set	157	Screwdrivers - Tpx Tip	324	Socket Set	199
Rivet Gun Set	184	Screwdrivers - Tx Tip	324	Socket Set	200
Rivet Gun Set	464	Screwdriver & Spanner Set	178	Socket Set	201
		Scriber	464	Socket Set	204
		Scriber	465	Socket Set	205

	Page No.		Page No.		Page No.
Socket Set	206	Stud Extractors	453	Top Box Cover	98
Socket Set	208	Stud Extractors	454	Torque Multiplier Service Kits	280
Socket Set	209	Suction Lifter	446	Torque Multiplier Set	137
Socket Set	210	Sv - Middle Box	87	Torque Multiplier Set	172
Socket Set	211	Sv - Top Box	84	Torque Multiplier Set	280
Socket Set	213	T Handle Bits Driver	352	Torque Multiplier Support Legs	279
Socket Set	214	T Handle Hex Key Set	146	Torque Multipliers	279
Socket Set	216	T Handle Hex Key Set	180	Torque Screwdriver	272
Socket Set	217	T Handle Hex Key Set	369	Torque Screwdriver Set	135
Socket Set	218	T Handle Hex Key Set	370	Torque Screwdriver Set	172
Socket Set	219	T Handle Hex Keys	365	Torque Screwdriver Set	171
Socket Set	220	T Handle Hex Keys	364	Torque Screwdriver Set	272
Socket Set	349	T Handle Nut Drivers	327	Torque Screwdriver Set	359
Soft Face Hammer	473	T Handle Tx & Tpx Keys	372	Torque Spanner Set	280
Spanner Ring	304	T Handle Tx And Tpx Key Set	146	Torque Spanners	280
Spanner Set	174	T Handle Tx And Tpx Key Set	373	Torque Stick & Wheel Nut Socket Set	134
Spare Blades	418	T Handle Tx Key Set	180	Torque Stick & Wheel Nut Socket Set	222
Spare Blades	419	T Handle Tx Key Set	373	Torque Sticks	264
Spare Blades	420	T Handle Tx/Tpx Key Set	189	Torque Test Printer	282
Spare Heads For Cp52	456	T Handle Tx/Tpx Key Set	374	Torque Tester Stand	282
Spare Pipe Cutter Blades	459	Tap And Die Set	152	Torque Tester With Stand & Printer	282
Spare Pipe Cutter Blades	460	Tap And Die Set	423	Torque Wrench Service Kits	277
Spare Wheel Set	469	Tap Chuck Service Kits	422	Torque Wrench Set	136
Spark Plug Boot Plier	439	Tap Handle	422	Torque Wrench Set	172
Spark Plug Socket Set	155	T-Bar Handle	235	Torque Wrench Set	274
Spark Plug Socket Set	183	T-Bar Socket Set	246	Torque Wrench Set	275
Spark Plug Socket Set	439	T-Bar Sockets	245	Torque Wrenches	273
Spark Plug Sockets	439	T-Bar Spark Plug Sockets	245	Torque Wrenches	274
Specialist Automotive Sockets	443	T-Bar Spark Plug Sockets	439	Torque Wrenches	276
Speed Braces	232	Telescopic Basin Tap Wrench	461	Tote Tray	98
Spinner Handle	231	Telescopic Inspection Mirror	465	Tower Pincer Pliers	382
Stack System	80	Telescopic Magnetic Pick Up Tool	465	Tpx Bit Socket Set	207
Stack System	81	Telescopic Magnetic Pick Up Tool	466	Tpx Bit Socket Set	215
Stack System Cover	98	Telescopic Magnifying Glass	465	Tpx Bit Sockets	247
Stack System Tool Kit	24-25	Telescopic Wheel Wrenches	444	Tpx Bit Sockets	253
Stack System Tool Kit	26-27	T-Handle Hex Key Set	189	Tpx Bits	341
Stack System Tool Kit	28-29	T-Handle Hex Key Set	370	Tweezers	391
Stack System Tool Kit	30-31	T-Handle Hex Key Set	371	Twin/Triple Leg Pullers	450
Stack System Tool Kit	32-33	Thread Cleaners	439	Tx Bit Impact Sockets	264
Stainless Steel Ratchets	229	Thread Gauge	429	Tx Bit Set	345
Stainless Steel Sockets	243	Three Lock Set	103	Tx Bit Set	346
Stainless Steel Sockets	249	Tj Socket Set	194	Tx Bit Socket Set	130
Steel Rules	429	Tool Back Pack	97	Tx Bit Socket Set	207
Storage Tray	122	Tool Bag	97	Tx Bit Socket Set	212
Storage Tray	123	Tool Box	97	Tx Bit Socket Set	215
Storage Tray	124	Tool Box Transport Trolley	103	Tx Bit Sockets	241
Storage Tray	162	Tool Cabinet	87	Tx Bit Sockets	247
Straight Air Impact Wrench	489	Tool Cabinet	88	Tx Bit Sockets	253
Straight Cut Tin Snips	414	Tool Cabinet	89	Tx Bits	339
Straight/Left Cut Tin Snips	414	Tool Cabinet	90	Tx Bits	340
Straight/Right Cut Tin Snips	414	Tool Cabinet	91	Tx Bits	341
Stubby 6 Point Impact Socket	261	Tool Cabinet Castor Wheels	102	Tx Impact Bit Socket Set	134
Stubby Combination Spanners	294	Tool Cabinet Top Tray	98	Tx Impact Bit Socket Set	222
Stubby Impact Socket Set	224	Tool Kit And Work Station	64-65	Tx Impact Screwdriver Bit	340
Stud Extractor	454	Tool Panel Set For Tcw207N	116	Tx Key Set	372
Stud Extractor Set	156	Tool Panels	112	Tx Key Set	373
Stud Extractor Set	454	Top Box	83	Tx Keys	371





Page No.

Tx-E Bit Socket Set	207
Tx-E Bit Socket Set	215
Tx-E Bit Sockets	240
Tx-E Bit Sockets	246
Tx-E Bit Sockets	251
Tyre Levers	444
Universal Joints	233
Universal Puller Set	155
Universal Puller Set	451
Utility And Craft Knife Set	151
Utility And Craft Knife Set	420
Vernier Caliper	428
Voltage Tester	458
Wall Cabinet	109
Wall Hanging Tool Cabinet	114
Wall Hanging Tool Cabinet	115
Water Pump Pliers	385
Welding Plier Set	150
Welding Power Grip Pliers	399
Wheel Nut Socket Set	444
Wheel Nut Socket Set	445
Wheel Nut Sockets	445
Wheel Tool Set	184
Wheel Tool Set	445
Wide Jaw Adjustable Wrenches	315
Wide Tool Cabinet	92
Wire Cutters	381
Wire Stripping Plier	389
Wire Stripping Tool	457
Wire Twisting Plier	458
Wobble Extension Bars	233
Wood Chisel Set	191
Wood Chisel Set	477
Wood Chisels	476
Wooktops For Tool Cabinets	102
Work Station Add-On Panel Set	113
Work Station Left/Right Add-On Panel Set	114
Work Station Panel Set	113
Work Tops	111
Workbench Panel Kit	112
Workbench Vice	100
Wrecking Bars	455
Xzn Bit Impact Sockets	264
Xzn Bit Sockets	254
Xzn Impact Bit Socket Set	221

Item ID	Page No.	Item ID	Page No.	Item ID	Page No.
1200-72N	228	1471 MM	368	220760	341
1200-72NRK	230	1471 MMA	368	220770	341
1200-72SN	229	1473	374, 445	220820	341
1200F	229	1474	367	220825	341
1200FRK	230	1475	366	220827	341
1200FRP	229	1476NAF	368	220830	341
1200FRPRK	230	1476NMM	367	220840	341
1200L	229	1476NMM1	367	220845	341
1201	232	1476NTX	372	220850	341
1201A	232	1476NTX1	373	220855	341
1201ARK	230, 232	1476NTX2	373	220860	341
1201RK	230, 232	1477NX	374	220870	341
1202	444	1479AF	367	2300	454
1202A	444	1479MM	366	2912512	319
120955-C	443	1479MMA	366	2912513	319
120970-C	443	1479MMR	365	2912514	319
1292AG-090	275	1479MMRL	366	2912520	319
1292AG-110	275	1479TX	372	2912535	319
1292AG-120	275	1479TX1	372	2912537	319
1292AG-140	275	1486	345	2912539	319
1292AG4-CT	274	1487	373	310102	362
1292AG4R-CT	274	1488	346	3101025	362
1292AG4RK	277	1492AG-CT	273	3101025BL	363
1292AG4RRK	277	1492AG-E	273	310103	362
1292AG-E4	274	1492AGERK	277	3101035	362
1292AG-E4R	274	1492TSD	272	310103BL	363
1292AG-EP	274	1499AF	367	310104	362
1292AG-ER	274	1499MM	366	3101045	362
1292AGERK	277	1499TX	372	310104BL	363
1292AGERRK	277	210705	342	310105	362
1292AGP-CT	274	210706	342	310105BL	363
1292AGR-CT	274	210707	342	310106	362
1292CQ200R	277	210708	342	310106BL	363
1292D200	275	210709	342	310107	362
1292D200-CT	275	210710	342	310107BL	363
1292P100	275	210712	342	310108	362
1292P100-CT	275	210714	342	310108BL	363
1292P100RK-1	277	210717	342	310110	362
1292P200	275	210719	342	310110BL	363
1292P200-CT	275	210805	343	310112	362
1292P200RK-1	277	210806	343	310112BL	363
1292P320	275	210807	343	310114	362
1292P320-CT	275	210808	343	310116	362
1292P418	277	210809	343	3105007	362
1292P912	277	210810	343	3105009	362
1400-72MN	228	210812	343	3105013	362
1400-72N	228	210814	343	3105015	362
1400-72NRK	230	210817	343	3105015BL-C	363
1400-72SN	229	210819	343	310502	362
1400B	228, 345	220720	341	3105025	362
1400FRP	229	220725	341	3105025BL-C	363
1400FRPRK	230	220727	341	310502BL-C	363
1400M	228	220730	341	310503	362
1424	369	220740	341	310503BL-C	363
1425	368	220745	341	310504	362
1471AF	368	220750	341	3105045	362
1471AFA	368	220755	341	310504BL-C	363



Item ID	Page No.	Item ID	Page No.	Item ID	Page No.
310505	362	3492AG-ER	276	4002IQ	314
3105055	362	3492AGERK	277	4002IQRK	314
310505BL-C	363	3492AGERRK	277	4002RK	314
310506	362	3492AGR-CT	276	4002WT	315
310506BL-C	363	3492CQ500R	277	4002WTRK	315
310507	362	3492P500	276	4003	314
310507BL-C	363	3492P500-CT	276	4003IQ	314
310508	362	3492P500RK-1	277	4003IQRK	314
310508BL-C	363	3800-72N	228	4003J	315
310509	362	3800-72NRK	230	4003JRK	315
310510	362	3800-72SN	229	4003RK	314
310510BL-C	363	3800FRP	229	4003WT	315
310512	362	3800FRPRK	230	4003WTRK	315
310514	362	3892AG1-CT	273	4004	314
310517	362	3892AG1RK	277	4004IQ	314
310519	362	3892AG3-CT	273	4004IQRK	314
310522	362	3892AG3RK	277	4004RK	314
310527	362	3892AG-E1	273	4004WT	315
310532	362	3892AG-E3	273	4004WTRK	315
310536	362	3892CQ100R	277	4005	314
320008	371	3892D100	273	4005IQ	314
320008BL	371	3892D100-CT	273	4005IQRK	314
320009	371	3892P060	273	4005RK	314
320009BL	371	3892P060-CT	273	4005WT	315
320010	371	3892P060RK-1	277	4005WTRK	315
320010BL	371	3892P100	273	4006	314
320015	371	3892P100-CT	273	4006IQ	314
320015BL	371	3901025BL	364	4006IQRK	314
320020	371	390103BL	364	4006RK	314
320020BL	371	390104BL	364	4007	314
320025	371	390105BL	364	4007RK	314
320025BL	371	390106BL	364	4008	314
320027	371	390107BL	364	4008RK	314
320027BL	371	390108BL	364	401-10	396
320030	371	390110BL	364	401-10F	396
320030BL	371	390112BL	364	401-12	396
320040	371	3905015BL	363	401-12F	396
320040BL	371	3905025BL	363	401-4	396
320045	371	390502BL	363	401-5	396
320045BL	371	390503BL	363	401-7	396
320050	371	390504BL	363	402	397
320050BL	371	390505BL	363	404-4	396
3205015	363	390506BL	363	404-6	396
320502	363	390508BL	363	404-6S	396
3205025	363	390510BL	363	404-9	396
320503	363	390908BL	371	406	398
320504	363	390909BL	371	406-6	398
320505	363	390910BL	371	406-6P	399
320506	363	390915BL	371	406-6S	398
320508	363	390920BL	371	406-6SP	399
320510	363	390925BL	371	406P	398
3492AG1-CT	276	390927BL	371	406S	398
3492AG2-CT	276	390930BL	371	406SP	399
3492AG-CT	276	390940BL	371	407	399
3492AG-E	276	4001	314	407AS	399
3492AG-E1	276	4001RK	314	408	400
3492AG-E2	276	4002	314	409	396, 440

Item ID	Page No.	Item ID	Page No.	Item ID	Page No.
409P	400	580C	99	600132	287
409SP	400	580CK	99	600134	287
410P	400	580CM	99	600136	287
410SP	400	580CN	99	600140	287
418S	399	580D	99	600142	287
418SP	399	580J	100	600144	287
445W	388	580K	99	600146	287
480	391	580M	99	600148	287
490	414	580N	99	600152	287
490W	415	580Q	470	600156	287
491	414	580R	470	600160	287
491W	415	580S	470	6005055	286
492	414	581N	467	600506	286
492W	415	581TMG	465	600507	286
493	414	581TMI	465	600507RF	300
494	414	581TMP	465	600508	286
495	414	582MI	466	60050809RXRK	309
496	379	582N	467	60050811 RX	308
497	415	583M	469	600508R	296
498-7N	381	583N	467	600508RF	300
510103	365	585	467	600508RS	298
510104	365	585MP	466	600509	286
510105	365	586	468	600509R	296
510106	365	586A	467	600509RF	300
510107	365	586C	467	600509RS	298
510108	365	587AA	468	600510	286
510110	365	587AE	468	60051011RXRK	309
510502	364	587AU	468	600510R	296
5105025	364	587H	468	600510RF	300
510503	364	587J	116	600510RS	298
510504	364	587M	468	600511	286
510505	364	589MA	116	600511 R	296
510506	364	589ME	116	600511 RF	300
510507	364	589MU	116	600511 RS	298
510508	364	600	304	600512	286
510510	364	600108	287	60051213RXRK	309
510512	364	600110	287	60051215RX	308
5106025	365	600110R	297	600512R	296
510603	365	600112	287	600512RF	300
510604	365	600112R	297	600512RS	298
510605	365	600114	287	600513	286
510606	365	600114R	297	600513R	296
510607	365	600116	287	600513RF	300
510608	365	600116R	297	600513RS	298
520009	372	600118	287	600514	286
520010	372	600118R	297	60051415RXRK	309
520015	372	600120	287	600514R	296
520020	372	600120R	297	600514RF	300
520025	372	600122	287	600514RS	298
520027	372	600122R	297	600515	286
520030	372	600124	287	600515R	296
520040	372	600124R	297	600515RF	300
520045	372	600126	287	600515RS	298
520050	372	600126R	297	600516	286
520055	372	600128	287	60051617RXRK	309
580	469	600128R	297	60051619RX	308
580A	470	600130	287	600516R	296



Item ID	Page No.	Item ID	Page No.	Item ID	Page No.
600516RF	300	6005M19	294	632022	301
600516RS	298	600813	310	632123	301
600517	286	600814	310	632224FL	302
600517R	296	600816	310	632427	301
600517RF	300	600817	310	633032	301
600517RS	298	600819	310	641011	308
600518	286	600822	310	641213	308
60051819XRK	309	600824	310	641314	308
600518R	296	600827	310	641617	308
600518RF	300	600830	310	641922	308
600518RS	298	600832	310	6503RX	308
600519	286	601013	302	6507AF	291
600519R	296	605908	295	6507JAF	292
600519RF	300	605909	295	6507JMM	291
600519RS	298	605910	295	6507JMMA	293
600520	286	605911	295	650809	307
600520RS	298	605912	295	6508RMM	298
600521	286	605913	295	6508RSMM	299
600521RS	298	605914	295	6509AF	291
600522	286	605915	295	651011	307
600522R	296	605916	295	651013	307
600522RS	298	605917	295	6510A	292
600523	286	605918	295	6510MM	289
600524	286	605919	295	6510RMM	298
600524R	296	6059LMP	296	6512	289
600524RS	298	611214	307	651213	307
600525	286	611618	307	6512MM	290
600526	286	612022	307	6512MM1	290
600527	286	620607	305	6512MMA	292
600527R	296	6208	306	6512N	288
600528	286	620809	305	6512RSMM	300
600529	286	621011	305	651415	307
600530	286	6211	306	6515MM	290
600530R	296	6211MM	306	6515MMA	292
600532	286	621213	305	651617	307
600532R	296	621415	305	6517	289
600533	286	621617	305	6517MM	290
600534	286	621819	305	651819	307
600536	286	622022	305	6521	289
600538	286	622123	305	6526MM	291
600541	286	622427	305	65RS12	300
600546	286	623032	305	6607AF	306
600550	286	630607	301	661416	308
600555	286	6308	303	663032	305
600558	286	630809	301	663436	305
600560	286	630810FL	302	663840	305
600565	286	6308MM	304	664244	305
600570	286	631011	301	664648	305
6005M10	294	6311	304	665052	305
6005M11	294	631113FL	302	665456	305
6005M12	294	631213	301	6707AF	304
6005M13	294	631214FL	302	673032	301
6005M14	294	631415	301	673436	301
6005M15	294	631617	301	673840	301
6005M16	294	631618FL	302	674244	301
6005M17	294	631719FL	302	674648	301
6005M18	294	631819	301	675052	301



Item ID	Page No.	Item ID	Page No.	Item ID	Page No.
675456	301	690815	278	800611	293
680608	309	690816	278	800612	293
680709	309	690817	278	800613	293
680810E	309	690818	278	800614	293
681013	309	690819	278	800615	293
681112E	309	690821	278	800616	293
681214	309	690822	278	800617	293
681416E	309	690824	278	800618	293
681719	309	690826	278	800619	293
681820E	309	690827	278	8512A	294
682122	309	690829	278	8512MM	294
682224E	309	690830	278	902024	312
690510	278	690832	278	902027	312
690511	278	690834	278	902030	312
690512	278	690836	278	902032	312
690513	278	690838	278	902036	312
690514	278	690840	278	902038	312
690515	278	690841	278	902041	312
690516	278	690842	278	902046	312
690517	278	690844	278	902050	312
690518	278	690846	278	902055	312
690519	278	691406	308	902060	312
690613	279	700-PRO5	417	902065	312
690614	279	701	416	902070	312
690615	279	701N	416	902075	312
690616	279	701N1	416	902080	312
690617	279	702	416	902085	312
690618	279	703	417	902090	312
690619	279	703-10	417	902095	312
690621	279	703-24	417	902100	312
690622	279	704	417	903024	312
690624	279	705	417	903027	312
690626	279	705-5	417	903030	312
690627	279	705A	417	903032	312
690629	279	705A-5	417	903036	312
690630	279	710	419	903038	312
690632	279	710-10	419	903041	312
690634	279	710-100	419	903046	312
690636	279	710-100H	420	903050	312
690638	279	710-10H	419	903055	312
690640	279	710A	417	903060	312
690641	279	710A-10	417, 418	903065	312
690642	279	710A-100	418	903070	312
690644	279	710C	418	903075	312
690646	279	710F	418	903080	312
690710	277	710F-10	418	903085	312
690711	277	710F-100	418	903090	312
690712	277	710G	418	903095	312
690713	277	710H	418	903100	312
690714	277	710N	419	910086	236
690715	277	710S	418	910504	358
690716	277	710U-10	419	910505	358
690717	277	711	419	910506	358
690718	277	712	419	910508	358
690719	277	800608	293	910510	358
690813	278	800609	293	910524	267
690814	278	800610	293	910527	267



Item ID	Page No.	Item ID	Page No.	Item ID	Page No.
910530	267	9124	461	920513AN	260
910532	267	9126	224	920513N	259
910533	267	920001	358	920514AN	260
910534	267	920002	358	920514N	259
910536	267	920003	358	920515AN	260
910538	267	920020AN	236	920515N	259
910541	267	920020N	236	920516AN	260
910546	267	920021AN	236	920516N	259
910550	267	920021N	236	920517AN	260
910555	267	920023AN	236	920517N	445
910560	267	920023N	236	920517N1	259
910565	267	920030AN	236	920518AN	260
910570	267	920030N	236	920518N	259
910575	267	920036AN	236	920519AN	260
910580	267	920036N	236	920519N	445
910585	267	920037AN	236	920519N1	259
910590	267	920037N	236	920520N	259
910595	267	920060-C	236	920521 AN	260
910624	268	920112	260	920521 N	445
910627	268	920114	260	920521 N1	259
910627R	268	920116	260	920522AN	260
910628	268	920118	260	920522N	259
910630	268	920120	260	920523N	259
910630R	268	920122	260	920524AN	260
910632	268	920124	260	920524N	259
910632R	268	920126	260	920525N	259
910633	268	920128	260	920526N	259
910633R	268	920130	260	920527N	259
910636	268	920132	260	920528N	259
910732	268	920134	260	920529N	259
9110	440	920136	260	920530N	259
9110RK-1	440	920140	260	920532N	259
9120	440	920212	262	920610AN	262
912041	269	920214	262	920610N	261
912046	269	920216	262	920611AN	262
912050	269	920218	262	920611N	261
912055	269	920220	262	920612AN	262
912060	269	920222	262	920612N	261
912065	269	920224	262	920613AN	262
912070	269	920226	262	920613N	261
912075	269	920228	262	920614AN	262
912080	269	920230	262	920614N	261
912085	269	920232	262	920615AN	262
912090	269	920234	262	920615N	261
912095	269	920236	262	920616AN	262
9120HD	440	920240	262	920616N	261
9120RK-1	440	920242	262, 443	920617AN	262
9121	224	920248	262, 443	920617N	261
912100	269	9203N	445	920618AN	262
912105	269	9203N1	444	920618N	261
912110	269	920508N	259	920619AN	262
912115	269	920510AN	260	920619N	261
912120	269	920510N	259	920620N	261
912125	269	920511AN	260	920621 AN	262
912130	269	920511N	259	920621 N	261
9123	440	920512AN	260	920622AN	262
9123RK	440	920512N	259	920622N	261

Item ID	Page No.	Item ID	Page No.	Item ID	Page No.
920623N	261	923090	264	940236	266
920624AN	262	923110	264	940238	266
920624N	261, 443	923120	264	940240	266
920627N	261, 443	923140	264	940242	266
920628N	261, 443	923814	264	940244	266
920629N	261, 443	923816	264	940246	266
920630N	261, 443	923817	264	940248	266
920632N	261, 443	923818	264	940250	266
920635N	261, 443	9291719	444	940252	266
920636N	261, 443	9292122	444	940254	266
920710-C	261	930001	358	940256	266
920712-C	261	930002	358	940258	266, 443
920713-C	261	930003	358	940260	266
920714-C	261	930004	358	940519-C	265
920715-C	261	9381	224	940521-C	265
920716-C	261	9386	224	940522-C	265
920717-C	261	940006	358	940523-C	265
920718-C	261	940008	358	940524-C	265
920719-C	261	940010	358	940527-C	265
920721-C	261	940012	358	940528-C	265
920722-C	261	940022-C	236	940530-C	265
920724-C	261	940030-C	236	940532-C	265
9207S12	224	940037-C	236	940533-C	265
921210TX-C	264	940085-C	236	940534-C	265
921215TX-C	264	940122	265	940536-C	265
921220TX-C	264	940124	265	940538-C	265
921225TX-C	264	940126	265	940540-C	265
921227TX-C	264	940128	265	940541-C	265
921230TX-C	264	940130	265	940546-C	265
921240TX-C	264	940132	265	940550-C	265
921245TX-C	264	940134	265	940619-C	266
921250TX-C	264	940136	265	940621-C	266
921255TX-C	264	940138	265	940622-C	266
921260TX-C	264	940140	265	940623-C	266
921270TX-C	264	940142	265	940624-C	266
921505-C	263	940144	265	940627-C	266
921506-C	263	940146	265	940630-C	266
921508-C	263	940148	265	940632-C	266
921510-C	263	940150	265	940633-C	266
921512-C	263	940152	265	940634-C	266
921514-C	263	940154	265	940636-C	266
921517-C	263	940156	265	940638-C	266
921519-C	263	940160	265	940641-C	266, 443
921606	263	940162	265	940646-C	266
921608	263	940164	265	940650-C	266
921610	263	940166	265	940732-C	267
921612	263	940168	265	941519-C	267
921614	263	940170	265	941522-C	267
921616	263	940172	265	941524-C	267
921618	263	940174	265	960506-C	258
921620	263	940176	265	960507-C	258
921622	263	940224	266	960508-C	258
921624	263	940226	266	960510-C	258
921814	264	940228	266	960513-C	258
921816	264	940230	266	970030	358
921817	264	940232	266	970040	358
921818	264	940234	266	970045	358



Item ID	Page No.	Item ID	Page No.	Item ID	Page No.
970050	358	ARB03	495	AT420	447
970055	358	ARBS10	493	AT500	450
980020-C	236	ARC80	491	AT605	458
980035-C	236	ARD10	489	BC408	380
980036A-C	236	ARD13	490	BC408T	380
980036-C	236	AREP25	495	BC414	380
980060-C	236	ARG01	492	BC414J	380
980086	236	ARG02	492	BC418	380
980508-C	258	ARN12	494	BC418J	380
980510-C	258	ARR12	484	BC424	380
980511-C	258	ARRG80	494	BC424J	380
980512-C	258	ARRG80-1RK	494	BC430	380
980513-C	258	ARRG80-3RK	494	BC430J	380
980514-C	258	ARRM38	484	BC436	380
980515-C	258	ARS01	490	BC436J	380
980516-C	258	ARS02	491	BWT406	461
980517-C	258	ARWC12	488	CALD150	428
980519-C	258	ARWC34	488	CALV150	428
980608-C	258	ARWC38	487	CC150F	475
980610-C	258	ARWM11S	489	CC200F	475
980611-C	258	ARWM12	486	CC240F	475
980612-C	258	ARWM12M	485	CC250F	475
980613-C	258	ARWM34	487	CMD12	471
980614-C	258	ARWM38	486	CMD16	471
980616-C	258	AT005	441	CMD20	471
980617-C	258	AT020	441	CMD25	471
980619-C	258	AT040	441	CMD30	471
981504-C	259	AT040-SM	441	CMD30A	471
981505-C	259	AT080	438	CMD40	471
981506-C	259	AT085	438	CMD40A	471
981507-C	259	AT090	438	CMD50	471
981508-C	259	AT096	385	CMD80	471
981510-C	259	AT097	385	CMF16	472
981512-C	259	AT135	465	CMF16T	471
9850	458	AT135M	465	CMF20	472
AB200	431	AT160	442	CMF20T	471
ABS-TOP	98	AT170	442	CMF25	472
ACC300CBH01	345	AT180	442	CMF25T	471
ACC35CBH01	344	AT180-S	442	CMF30	472
ACC50CBH01	344	AT191	443	CMF30T	471
ACC50MBH01	344	AT192	443	CMF35	472
ACC70MBH01	344	AT194	443	CMF35T	471
ACCSDA1412	345	AT195	443	CMFQ20	472
ACCSDA1414	345	AT200	443	CMFQ25	472
ACCSDA1438	345	AT20512	444	CMFQ30	472
ACD01	280	AT20516	444	CMFQ40	472
ALU1000-1	101	AT20520	444	CMQ150	471
ALU1000-4	101	AT20524	444	CMQ300	471
ALU12	101	AT330	442	CMQ450	471
ALU14	101	AT350	443	CMQ600	471
ALU34	101	AT355	443	CMQL150	471
ALU38	101	AT360	443	CMQL300	471
ALU430	101	AT365	443	CMQL450	471
ALU450	101	AT370	443	CP04	474
ARAG125	493	AT375	443	CP04RK1	456
ARB01	495	AT380	443	CP04RK2	456
ARB02	495	AT415	447	CP04RK3	456

Item ID	Page No.	Item ID	Page No.	Item ID	Page No.
CP05	474	DP1012	441	HEXP3000305	342
CP08	474	DP1112	441	HEXP3000401	342
CP50	456	DP1314	441	HEXP3000405	342
CP51	456	DP1716	441	HEXP3000501	342
CP52	456	DTQ100RK	277	HEXP3000505	342
CP53	456	DTQ200RK	277	HEXP3000601	342
CP55	457	FC01	446	HEXP3000605	342
CP58	456	FG13100	429	HEXP5000301	342
CP60	457	FG20100	429	HEXP5000401	342
CTG01	458	FG20200	429	HEXP5000501	342
DB028	421	FL2506A03	336	HEXP5000601	342
DB034	421	FL2506B03	336	HMBH01	446
DBT35	460	FL2508A03	336	HMBH02	446
DBT41	460	FL2508B03	336	HMBH03	447
DBT54	460	FL2510A03	336	HMBH16	474
DBX010	420	FL2512A03	336	HMBP12	473
DBX015	420	FL2516A03	336	HMBP16	473
DBX020	420	FL5006A03	336	HMBP24	473
DBX025	420	FL5008A03	336	HMBP32	473
DBX030	420	FL5008B03	336	HMCH08A	473
DBX033	420	FL5010A03	336	HMCH13A	473
DBX035	420	FL5012A03	336	HMCH16A	473
DBX040	420	FL7006A02	336	HMCH16M	474
DBX042	420	FL7008A02	336	HMCH20A	473
DBX045	420	FL7008B02	336	HMCHC16	474
DBX050	420	FL7010A02	336	HMCHM16	473
DBX055	420	FL8905A01	336	HMDH35	447
DBX060	420	FL8908A01	336	HMDH45	447
DBX065	420	FLFT10	425	HMDH55	447
DBX068	420	FLHF10	425	HMDH65	447
DBX070	420	FLHR10	425	HMEG300	473
DBX075	420	FLRD10	425	HMEG500	473
DBX080	420	FLSQ10	426	HMEG800	473
DBX085	420	FLTR10	425	HMS1250	473
DBX090	420	FTF32406005	336	HMSF	473
DBX095	420	FTF4055	325	HMSFRK	473
DBX100	420	GR25002010	337	HN02	463
DBX105	420	GR25002100	337	HN02RK	463
DBX110	420	GRP3000201	338	HP101	311
DBX115	420	GRP3000205	338	HP102	311
DBX120	420	GRP5000201	338	HP103	311
DBX125	420	HBH0303	325	HP2014	311
DBX130	420	HBH0404	325	HP2014-P	311
DET01	461	HBH0505	325	HP2015	311
DET01RK	461	HBH0606	325	HP2015-P	311
DET02	461	HEX2500203	341	HP2025	311
DGMM	428	HEX2500303	341	HP2026	311
DHW1300	472	HEX2500403	341	HP2026-P	311
DHW1417	472	HEX2500503	341	HP2036	311
DHW1922	472	HEX2500603	341	HP2036-P	311
DIE-HNDL	422	HEX2500803	341	HP2038	311
DIS-SP05	452	HEX5000403	342	HP2038-P	311
DIS-SP05Q	452	HEX5000503	342	HR01	463
DM500	458	HEX5000603	342	HR01RK	463
DM550	459	HEX5000803	342	HR12	462
DP0810	441	HEX8900401	342	HR12RK	462, 463
DP0812	441	HEXP3000301	342	HR14	462





Item ID	Page No.	Item ID	Page No.	Item ID	Page No.
HR14RK	462	M120037-C	234	M120523-C	248
HR30R	462	M120037M	234	M1205246-C	248
HR30RRK-1	462	M120040-C	439	M120524-C	248
HR30RRK-2	462	M120042-C	439	M1205256-C	248
HR360R	463	M120046-C	439	M120525-C	248
HRLN65N	463	M120050-C	235	M1205266-C	248
HRLN65NRK-1	463	M120060-C	234, 345	M120526-C	248
HRLR01	463	M120061-C	234, 345	M1205276-C	248
HRLR01RK-2	463	M120062-C	234, 345	M120527-C	248
HRLR01RK-3	463	M120063-C	234, 345	M1205286-C	248
HRLT01	463	M120080-C	233	M120528-C	248
HRLT01RK	463	M120112-C	249	M1205296-C	248
IBA14	344	M120114-C	249	M120529-C	248
ID506	356	M120116-C	249	M1205306-C	248
ID506BIT	356	M120118-C	249	M120530-C	248
ID515	356	M120119-C	249	M1205326-C	248
ID515BIT	356	M120120-C	249	M120532-C	248
IDSE7	358	M120122-C	249	M1205336-C	248
KP01	468	M120124-C	249	M1205346-C	248
KP02	468	M120125-C	249	M120534-C	248
KP03	469	M120126-C	249	M120610-C	250
M1100	230	M120128-C	249	M120611-C	250
M110010	230	M120130-C	249	M120612-C	250
M110020	230	M120132-C	249	M1206136-C	250
M110030	234	M120134-C	249	M120613-C	250
M110040	232	M120136-C	249	M1206146-C	250
M110050	232	M120138-C	249	M120614-C	250
M110070	232	M120140-C	249	M1206156-C	250
M110070RK	232	M120508-C	248	M120615-C	250
M1100-72	229	M120509-C	248	M1206166-C	250
M1100-72RK	230	M1205106-C	248	M120616-C	250
M1100RK	230	M120510-C	248	M1206176-C	250
M110536	255	M1205116-C	248	M120617-C	250
M110541	255	M120511-C	248	M1206186-C	250
M110546	255	M1205126-C	248	M120618-C	250
M110550	255	M120512-C	248	M1206196-C	250
M110555	255	M1205136-C	248	M120619-C	250
M110558	255	M120513-C	248	M120620-C	250
M110560	255	M1205146-C	248	M120621-C	250
M110565	255	M120514-C	248	M120622-C	250
M110570	255	M1205156-C	248	M1206246-C	250
M110575	255	M120515-C	248	M120624-C	250
M110580	255	M1205166-C	248	M120627-C	250
M1115MM	218	M120516-C	248	M120630-C	250
M120010-C	232	M1205176-C	248	M120632-C	250
M120010RK	232	M120517-C	248	M120636-C	250
M120011-C	232	M1205186-C	248	M1207	213
M120020-C	232	M120518-C	248	M120710-C	251
M120020W-C	233	M1205196-C	248	M120711-C	251
M120021-C	232	M120519-C	248	M120712-C	251
M120021W-C	233	M1205206-C	248	M120714-C	251
M120022-C	232	M120520-C	248	M120716-C	251
M120022W-C	233	M1205216-C	248	M120718-C	251
M120023-C	232	M120521-C	248	M120720-C	251
M120024-C	232	M1205226-C	248	M120722-C	251
M120030-C	233	M120522-C	248	M120724-C	251
M120036-C	234	M1205236-C	248	M1208-6	214

Item ID	Page No.	Item ID	Page No.	Item ID	Page No.
M1209AF	214	M122506A-C	252	M140111-C	238
M1210	215	M122506-C	252	M14011212-C	239
M1211	214	M122507-C	252	M140112-C	238
M121106-C	252	M122508A-C	252	M14011412-C	239
M121107-C	252	M122508-C	252	M140114-C	238
M121108-C	252	M122510-C	252	M14011612-C	239
M121109-C	252	M122510L-C	252	M140116-C	238
M121110-C	252	M122512-C	252	M14020612-C	240
M121112-C	252	M122514-C	252	M140206-C	240
M121116-C	252	M122517-C	252	M14020712-C	240
M121118-C	252	M122704-C	253	M140207-C	240
M121120-C	252	M122705-C	253	M14020812-C	240
M1212	214	M122706-C	253	M140208-C	240
M121220-C	253	M122708-C	253	M14020912-C	240
M121220T-C	253	M122709-C	253	M140209-C	240
M121225-C	253	M122710-C	253	M14021012-C	240
M121225T-C	253	M122711-C	253	M140210-C	240
M121227-C	253	M122712-C	253	M14021112-C	240
M121227T-C	253	M122713-C	253	M140211-C	240
M121230-C	253	M122805-C	254	M14021212-C	240
M121230T-C	253	M122806-C	254	M140212-C	240
M121240-C	253	M122808-C	254	M14021412-C	240
M121240T-C	253	M122809-C	254	M140214-C	240
M121245-C	253	M122810-C	254	M14021612-C	240
M121245T-C	253	M122812-C	254	M140216-C	240
M121250-C	253	M122814-C	254	M14050412-C	238
M121250T-C	253	M122816-C	254	M1405045-C	237
M121255-C	253	M140015-C	231	M140504-C	237
M121255T-C	253	M140020-C	232	M14050512-C	238
M121260-C	253	M140021-C	232	M140505512-C	238
M121260T-C	253	M140022-C	232	M1405055-C	237
M1212N1	208	M140023-C	232	M140505-C	237
M1213TPX	215	M140024-C	232	M14050612-C	238
M1213TX	215	M140030-C	233	M140506-C	237
M121505-C	251	M140036-C	234	M14050712-C	238
M121506-C	251	M140036M	234	M140507-C	237
M121507-C	251	M140037	234	M14050812-C	238
M121508-C	251	M140038-C	232	M140508-C	237
M121509-C	251	M140039	234	M14050912-C	238
M121510-C	251	M140050-C	235	M140509-C	237
M121512-C	251	M140060-C	234, 345	M14051012-C	238
M121514-C	251	M140070	422	M140510-C	237
M121517-C	251	M140071	422	M14051112-C	238
M121519-C	251	M140071RK	422	M140511-C	237
M1215AF	213	M140072	422	M14051212-C	238
M1215MM	213	M140072RK	422	M140512-C	237
M122220T-C	253	M14010612-C	239	M14051312-C	238
M122225T-C	253	M140106-C	238	M140513-C	237
M122227T-C	253	M14010712-C	239	M140604-C	239
M122230T-C	253	M140107-C	238	M1406055-C	239
M122240T-C	253	M14010812-C	239	M140605-C	239
M122245T-C	253	M140108-C	238	M14060612-C	239
M122250T-C	253	M14010912-C	239	M140606-C	239
M122255T-C	253	M140109-C	238	M14060712-C	239
M122260T-C	253	M14011012-C	239	M140607-C	239
M122270T-C	253	M140110-C	238	M14060812-C	239
M122505-C	252	M14011112-C	239	M140608-C	239



Item ID	Page No.	Item ID	Page No.	Item ID	Page No.
M140609-C	239	M340132-C	255	M380061-C	234, 345
M14061012-C	239	M340134-C	255	M380110-C	243
M140610-C	239	M340136-C	255	M38011212-C	243
M140611-C	239	M340138-C	255	M380112-C	243
M14061212-C	239	M340140-C	255	M38011412-C	243
M140612-C	239	M340142-C	255	M380114-C	243
M14061312-C	239	M340144-C	255	M38011612-C	243
M140613-C	239	M340146-C	255	M380116-C	243
M1407	199	M340148-C	255	M38011812-C	243
M140704-C	240	M340152-C	255	M380118-C	243
M140705-C	240	M340156-C	255	M38012012-C	243
M140706-C	240	M340158-C	255	M380120-C	243
M140707-C	240	M340160-C	255	M38012212-C	243
M140708-C	240	M340164-C	255	M380122-C	243
M1408TX	199	M3405196-C	254	M38012412-C	243
M1410T5	346	M3405216-C	254	M380124-C	243
M1412	199	M3405226-C	254	M380126-C	243
M141210T-C	241	M3405246-C	254	M380128-C	243
M141215T-C	241	M3405266-C	254	M38021212-C	245
M141220T-C	241	M3405276-C	254	M380212-C	245
M141225T-C	241	M3405306-C	254	M38021412-C	245
M141227T-C	241	M3405326-C	254	M380214-C	245
M141230T-C	241	M3405336-C	254	M38021612-C	245
M141240T-C	241	M3405346-C	254	M380216-C	245
M141300-C	241	M3405366-C	254	M38021812-C	245
M141301-C	241	M3405386-C	254	M380218-C	245
M141302-C	241	M3405416-C	254	M38022012-C	245
M141303-C	241	M3405466-C	254	M380220-C	245
M1413N1	194	M3405506-C	254	M38022212-C	245
M141404-C	240	M341514-C	255	M380222-C	245
M1414055-C	240	M341517-C	255	M38022412-C	245
M141407-C	240	M341519-C	255	M380224-C	245
M141601-C	241	M341522-C	255	M380226-C	245
M141602-C	241	M380010A-C	232	M380228-C	245
M141603-C	241	M380011-C	232	M380507-C	242
M340020-C	232	M380015-C	231	M38050812-C	242
M340020S-C	232	M380020-C	232	M380508-C	242
M340021-C	232	M380020W-C	233	M38050912-C	242
M340021S-C	232	M380021-C	232	M380509-C	242
M340022-C	232	M380021W-C	233	M38051012-C	242
M340022S-C	232	M380022-C	232	M380510-C	242
M340030-C	233	M380022W-C	233	M38051112-C	242
M340050-C	235	M380023-C	232	M380511-C	242
M340050S-C	235	M380024-C	232	M38051212-C	242
M340070-C	232	M380030-C	233	M380512-C	242
M340070RK	232	M380035-C	234	M38051312-C	242
M340070S-C	232	M380036-C	234	M380513-C	242
M340070SRK	232	M380036M	234	M38051412-C	242
M3400-72	229	M380037	234	M380514-C	242
M340072E	230	M380039-C	439	M38051512-C	242
M3400-72RK	230	M380040-C	439	M380515-C	242
M340085-C	234	M380041-C	439	M38051612-C	242
M340085M	234	M380042-C	439	M380516-C	242
M340086-C	234	M380046-C	439	M38051712-C	242
M340124-C	255	M380047-C	439	M380517-C	242
M340128-C	255	M380050-C	235	M38051812-C	242
M340130-C	255	M380060-C	234, 345	M380518-C	242

Item ID	Page No.	Item ID	Page No.	Item ID	Page No.
M38051912-C	242	M381215-C	247	MB444-8	379
M380519-C	242	M381215T-C	247	MB444-8T	379
M380520-C	242	M381220-C	247	MB445-10	379
M380521-C	242	M381220T-C	247	MB448-6	381
M38052212-C	242	M381225-C	247	MB448-8	381
M380522-C	242	M381225T-C	247	MB449-10	382
M38060712-C	244	M381227-C	247	MB449-11	382
M380607-C	244	M381227T-C	247	MB449-9	382
M38060812-C	244	M381230-C	247	MB451-7	383
M380608-C	244	M381230T-C	247	MB451-8	383
M38060912-C	244	M381240-C	247	MB452-6	383
M380609-C	244	M381240T-C	247	MB452-6T	383
M38061012-C	244	M381245-C	247	MB452-7	383
M380610-C	244	M381245T-C	247	MB452-7T	383
M38061112-C	244	M381250-C	247	MB452-8	383
M380611-C	244	M381250T-C	247	MB452-8T	383
M38061212-C	244	M3812N1	200	MB452-9	383
M380612-C	244	M3813TPX	207	MB461-5	383
M38061312-C	244	M3813TX	207	MB461-6	383
M380613-C	244	M3814	207	MB461-6T	383
M38061412-C	244	M381503-C	246	MB461-8	383
M380614-C	244	M381504-C	246	MB461-8T	383
M38061512-C	244	M3815055-C	246	MB463-5	384
M380615-C	244	M381505-C	246	MB463-6	384
M38061612-C	244	M381506-C	246	MB463-8	384
M380616-C	244	M381507-C	246	MB463-8T	384
M38061712-C	244	M381508-C	246	MB464-6	384
M380617-C	244	M381510-C	246	MB464-6T	384
M38061812-C	244	M381512-C	246	MB465-6	384
M380618-C	244	M3816	206	MB470-5	393
M38061912-C	244	M386510-C	247	MB470-7	393
M380619-C	244	M386511-C	247	MB470-9	393
M38062012-C	244	M386512-C	247	MB471-5	393
M380620-C	244	M386513-C	247	MB471-7	393
M38062112-C	244	M386514-C	247	MB471-9	393
M380621-C	244	M386515-C	247	MB472-5	393
M38062212-C	244	M386516-C	247	MB472-7	393
M380622-C	244	M386517-C	247	MB472-9	393
M3807	206	M386518-C	247	MB473-5	393
M380710-C	246	M386519-C	247	MB473-7	393
M380712-C	246	MB410	385	MB473-9	393
M380714-C	246	MB412	385	MB481-10	385
M380716-C	246	MB416	385	MB481-10Q	385
M380718-C	246	MB441-5	378	MB481-10T	385
M3808MM	207,247	MB441-5T	378	MB481-10TQ	386
M3811	207	MB441-6	378	MB481-7	385
M381103-C	246	MB441-6T	378	MB481-7T	385
M381104-C	246	MB442-5	378	MB482-10Q	386
M381105-C	246	MB442-6	378	MB482-10TQ	386
M381106-C	246	MB442-6T	378	MB482-7Q	386
M381107-C	246	MB442-7	378	MB489-7	382
M381108-C	246	MB442-7S	378	MB489-8	382
M381110-C	246	MB442-8	378	MB499-7T	389
M381112-C	246	MB442-8T	378	MB541-5	381
M3812	207	MB442B-8T	378	MB541-6	381
M381210-C	247	MB444-10	379	MB541-7	381
M381210T-C	247	MB444-6	379	MBE470-7	392



Item ID	Page No.	Item ID	Page No.	Item ID	Page No.
MBE471-7	392	MD908TN	324	MD950N	323
MBE472-7	392	MD909TN	324	MD952N	323
MBE473-7	392	MD910N	331	MD952N1	323
MBHI14	344	MD910TN	324	MD953N	323
MBM441	389	MD911N	331	MD954N	323
MBM449	389	MD912N	333	MD960N	323
MBM461	389	MD912N1	333, 408	MD961N	323
MBM464	390	MD914N	322	MD961N1	323
MBM467	390	MD915N	322	MD961N2	323
MBM468	390	MD915N1	322	MD962N	323
MBM469	390	MD915TN	324	MD962N1	323
MBV441-6	409	MD916N	322	MD962N2	323
MBV442-8	409	MD916N1	322	MD962N3	323
MBV451-7	409	MD916N2	322	MD962N4	323
MBV451-8	409	MD917N	322	MD962N4A	323
MBV461-8	410	MD917N1	322	MD962N4C	323
MBV499-7	410	MD917N2	322	MD962N4D	323
MD193	351	MD920N	322	MD962N5	323
MD216	351	MD920N1	322	MD963N	323
MD503N	438	MD920TN	324	MD964N	323
MD503NA	438	MD922N	322	MDA180	436
MD503ND	438	MD923N	322	MDA-R	436
MD503RK	438	MD923N1	322	MDA-SQ	436
MD514L	231	MD925TN	324	MDBH	351
MD514N	231	MD927TN	324	MDH-L	436
MD610TPN	324	MD928N	322	MDH-S	436
MD615TPN	324	MD928N1	322	MDM700	319
MD620TPN	324	MD928N2	322	MDM706	319
MD625TPN	324	MD928N3	322	MDM706TX	319
MD627TPN	324	MD928N4	322	MDM706TXT	320
MD630TPN	324	MD928N5	322	MDM711	318
MD640TPN	324	MD928N6	322	MDM712	318
MD7020HBN	325	MD928N7	322	MDM713	318
MD7020HN	324	MD930N	322	MDM714	318
MD7025HBN	325	MD930TN	324	MDM715	318
MD7025HN	324	MD931N	322	MDM716	318
MD7030HBN	325	MD932N	322	MDM717	318
MD7030HN	324	MD932N1	322	MDM718	318
MD7040HBN	325	MD932N2	322	MDM806	318
MD7050HBN	325	MD934N	322	MDM806T	320
MD7060HBN	325	MD935N	322	MDM807	318
MD7080HBN	325	MD940N	323	MDM807T	320
MD801N	325	MD940N1	323	MDM808	318
MD802N	325	MD940TN	324	MDM808T	320
MD803N	325	MD945TN	324	MDM809	318
MD901	325	MD947N	323	MDM809T	320
MD9053N	330	MD947N1	323	MDM810	318
MD906N	332	MD947N2	323	MDM810T	320
MD906N1	333	MD948N	323	MDM815	318
MD906N2	332	MD948N1	323	MDM815T	320
MD906N3	332	MD948N2	323	MDMC702N	321
MD906N4	332	MD948N3	323	MDMC715N	321
MD906N5	331	MD948N4	323	MDMC718N	320
MD906TN	324	MD948N5	323	MDN505	327
MD907FL	351	MD948N6	323	MDN5055	327
MD907TN	324	MD948N8	323	MDN506	327
MD908N	352	MD949N	323	MDN507	327



Item ID	Page No.	Item ID	Page No.	Item ID	Page No.
MDN508	327	MDV840N	404	MS380516-C	243
MDN510	327	MDV842N	404	MS380517-C	243
MDN511	327	MDV844N	404	MS380518-C	243
MDN512	327	MDV844NF	405	MS380519-C	243
MDN513	327	MDV846N	404	MS3814	206
MDNT405	327	MDV860N	405	MT03	432
MDNT4055	327	MDV862N	405	MT03MM	432
MDNT406	327	MDV864N	405	MT05	432
MDNT407	327	MDV864NF	405	MT05MM	432
MDNT408	327	MDV866N	405	MT08	432
MDNT409	327	MDV906N	408	MT08MM	432
MDNT410	327	MDV9855	458	MT10	432
MDNT411	327	MH75	470	MT15	432
MDNT412	327	MH90	470	MT30	432
MDNT413	327	MIR25	428	MTS30	432
MDNT414	327	MP1400	279	MTS50	432
MDP125	437	MP1400RK-1	280	MX04	235
MDP35	437	MP2700	279	NS02	453
MDP90	437	MP2700RK-1	280	NS02RKL	453
MDQ147	352	MP91500	279	NS02RKS	453
MDQ183	352	MP91500RK	280	NS45108M	343
MDQ217	352	MPSL01	279	NS45506M	343
MDR908	353	MPSL02	279	NS45507M	343
MDR9085	352	MR500	328	NS45508M	343
MDR915	353	MS1200	229	NS45508R	343
MDRQ908	353	MS120021-C	232	NSP65108	344
MDRT908	353	MS120036-C	234	NSP65507	344
MD-SCR	436	MS1200RK	230	NSP65508	344
MDT932N	326	MS1203	214	NSP65510	344
MDT934N	326	MS1205106-C	249	NSP65513	344
MDT935N	326	MS1205116-C	249	O9100115	237
MDT952N	326	MS1205126-C	249	O910075	237
MDT953N	326	MS1205136-C	249	O92194	237
MDTHQ	352	MS1205146-C	249	O92244	237
MDV700	406	MS1205156-C	249	O92416	237
MDV710	406	MS1205166-C	249	O92419	237
MDV724N	404	MS1205176-C	249	O935202	237
MDV726N	404	MS1205186-C	249	O93525	237
MDV731	406	MS1205196-C	249	O93528	237
MDV732	406	MS1205216-C	249	O93530	237
MDV733	406	MS1205246-C	249	O93532	237
MDV734	406	MS1206176-C	251	O93534	237
MDV742N	404	MS1206196-C	251	O93538	237
MDV744N	404	MS1206216-C	251	O93546	237
MDV751	406	MS3800	229	O93548	237
MDV752	406	MS380020-C	232	O95034	237
MDV762N	405	MS380023-C	232	O95036	237
MDV764N	405	MS380036-C	234	O95046	237
MDV771	406	MS3800RK	230	O95775	237
MDV772	406	MS380508-C	243	O97043	237
MDV802N	405	MS380509-C	243	O97045	237
MDV820N	404	MS380510-C	243	O97051	237
MDV822N	404	MS380511-C	243	P902515	236
MDV823N	404	MS380512-C	243	P902518	236
MDV824N	404	MS380513-C	243	P90324	236
MDV826N	404	MS380514-C	243	P90328	236
MDV828N	404	MS380515-C	243	P90332	236



Item ID	Page No.	Item ID	Page No.	Item ID	Page No.
P90433	236	PP05	474	RSC1340450	109
P90435	236	PP06	474	RSC700450	109
P90437	236	PP07	474	RSC800450	109
P90445	236	PP08	474	RSCCH800	109
P90543	236	PPS06	476	RSCH1340450	109
P90545	236	P-SG01	481	RSCH700450	109
P90551	236	P-SG02	481	RSCH800450	109
P906110	236	P-SG03	481	RSCW1340300	109
P90675	236	PT3810R	231	RSCW700300	109
P92320	236	P-UKF	419	RSCW800300	109
P92325	236	PWC12	389	RSD070004	111
PB12	455	PWC14	389	RSD135004	111
PB12A	455	PWC18	389	RSE0700	112
PB16	455	PWC24	389	RSE0800	112
PB18A	455	PWC36	389	RSE1340	112
PB20	455	PZ2500103	338	RSK0700	110
PB22A	455	PZ2500110	338	RSK0700A	110
PCCAP	475	PZ2500203	338	RSK0800	110
PCX05	476	PZ2500210	338	RSK1350	110
PF190	455	PZ2500303	338	RSK1350A	110
PF380	455	PZ2500310	338	RSKC02	110
PGW1719	310	PZ5000103	338	RSMB0700	108
PGW1922	310	PZ5000203	338	RSMB0800	108
PGW1924	310	PZ5000303	338	RSMB1340	108
PGW2124	310	PZ7000102	338	RSMC0700	108
PGW2430	310	PZ7000202	338	RSMC0800	108
PGW2730	310	PZ8900101	338	RSMC1340	108
PH2500103	337	PZ8900201	338	RSMFD0700	108
PH2500110	337	PZP3000101	339	RSMFD1340	108
PH2500203	337	PZP3000105	339	RSML	106
PH2500210	337	PZP3000201	339	RSML1001	69
PH2500303	337	PZP3000205	339	RSML333	77
PH2500310	337	PZP3000301	339	RSML417	75
PH5000103	337	PZP3000305	339	RSML569	73
PH5000203	337	PZP5000101	339	RSML715	71
PH5000303	337	PZP5000201	339	RSMM	107
PH7000102	337	PZP5000301	339	RSMM1001	69
PH7000202	337	PZP8900201	339	RSMM333	77
PH8900101	337	PZZ0102	325	RSMM417	75
PH8900201	337	PZZ32000305	338	RSMM569	73
PHF0365	325	PZZ32010205	338	RSMM715	71
PHH0102	325	QCI14	344	RSMS	107
PHH32000305	336	RHA14	228, 345	RSMS333	77
PHH32010205	336	ROB2500103	343	RSMS417	75
PHP3000101	337	ROB2500203	343	RSMS569	73
PHP3000105	337	ROB2500303	343	RSMS715	71
PHP3000201	337	ROBP3000101	343	RSMSD0700	108
PHP3000205	337	ROBP3000105	343	RSMSD1340	108
PHP3000301	337	ROBP3000201	343	RSMXL	106
PHP3000305	337	ROBP3000205	343	RSMXL1001	69
PHP5000101	337	ROBP5000101	343	RSMXL333	77
PHP5000201	337	ROBP5000201	343	RSMXL417	75
PHP5000301	337	ROBP5000301	343	RSMXL569	73
PHP8900201	337	ROBP8900101	343	RSMXL715	71
PM14	228	ROBP8900201	343	RSRU01N	112
PP03	474	ROBP8900301	343	RSS0700	111
PP04	474	RS72	112	RSS0800	111

Item ID	Page No.	Item ID	Page No.	Item ID	Page No.
RSS1350	111	SLA2000	433	ST12322	454
RSSC01	111	SLM0300	433	ST12324	454
RSSS1350	111	SLM0400	433	ST12325	454
RSSS700	111	SLM0600	433	ST12506-C	453
RSTKP1340	111	SLM1000	433	ST12506RK-1	453
RSTKP700	111	SLM1200	433	ST12508-C	453
RSTKP800	111	SLP1160	391	ST12508RK-1	453
RSTKPCC	111	SLP2180	391	ST12510-C	453
RSTP0700	112	SLP3160	391	ST12510RK-1	453
RSTP0800	112	SLP3180	391	ST12512-C	453
RSTP1340	112	SLT01	433	ST12512RK-1	453
RSTSB	111	SLT02	433	ST150	429
RSWB0700	111	SP11	450	ST200	429
RSWB0800	111	SP1410	450	ST38112	454
RSWB1340	111	SP1410Q	451	ST38116	454
SC01	58	SP1810	450	ST38122	454
SC02	58	SP1810Q	451	ST38306	454
SC03	59	SP22	450	ST38308	454
SC04	59	SP2215	450	ST38310	454
SC04E	60	SP2215Q	451	ST38311	454
SCE1	60	SP2615	450	ST38312	454
SCE2	61	SP2615Q	451	ST38313	454
SCP01	474	SP31410	451	ST38314	454
SCPS01	125	SP31410Q	451	ST38316	454
SCPS01E	125	SP31810	451	ST38317	454
SCR01	464	SP31810Q	451	T1220AF	208
SCR02	465	SP32215	451	T1221	208
SD501	466	SP32215Q	451	T1221-6	208
SE05	453	SP32615	451	T1230	209
SE141	452	SP32615Q	451	T1234	209
SE142	452	SP3320	450	T1244	209
SE143	452	SP3320Q	451	T1268	210
SEL01S	452	SP33320	451	T1272	218
SEL02S	452	SP33320Q	451	T1408	195
SEL03S	452	SPA11	450	T1419	195, 349
SEL04S	452	SPA22	450	T1420	195, 349
SEL05S	452	SPBP20	439	T1422	195
SG001	480	SQAA200	431	T1423	196
SG002	480	SQAA250	431	T1424	196
SG003	481	SQAA300	431	T1424S	196
SG713	480	SQAB10070	430	T1435AF	196
SG713G	480	SQAB150100	430	T1436	197
SG960	479	SQAB200130	430	T1460	197
SG960A	479	SQAB300175	430	T3418-6	216
SG960G	479	SQAC300	431	T3422S	216
SG960Y	479	SQAP250	431	T3834	200
SL01	446	SQAP300	431	T3834S	200
SL02	446	SR1160	415	T3835AF	200
SL03	446	SR1180	415	T3839	201
SLA0300	433	SR2180	416	T3840	201
SLA040	433	SR3160	416	T3848	202
SLA0400	433	SSH01	477	T3867	202
SLA0600	433	SSH02	477	T9206	221
SLA1000	433	SSH03	477	TAP-HNDL	422
SLA1200	433	SSH04	478	TBBSI27	350
SLA1500	433	ST12319	454	TBNSI5	351
SLA1800	433	ST12321	454	TBSKT07	245



Item ID	Page No.	Item ID	Page No.	Item ID	Page No.
TBSKT08	245	TC-COVER	98	TC-S03AL	114
TBSKT10	245	TC-COVER1	98	TC-S03AR	114
TBSKT12	245	TCDIVL	99	TC-S04	116
TBSKT13	245	TCDIVS	99	TCSB	97
TBSKT14	245	TCDRK	104	TCSB16	97
TBSKT17	245	TCDSH	102	TC-SC	96
TBSKT19	245	TCEMM249N	38-39	TC-SL01	113
TBUSP14	439	TCEMM417N	36-37	TC-SL02	113
TBUSP16	439	TCEMM631N	48-49	TC-SL03AL	114
TBUSP21	439	TCF01	99	TC-SL03AR	114
TBW10	246	TCF02	99	TCSMC	103
TC103NF	96	TCF03	99	TCT01	115
TC144D	63	TC-FB01	115	TCT02	115
TC144E	63	TC-FB02	115	TCT03	115
TC-160UR	115	TC-FB03	115	TCT04	115
TC-180CLOCK	104	TC-H01	115	TC-TB01	102
TC187	62	TC-H02	115	TC-TB02	102
TC-3	96	TC-H03	115	TC-TB03	102
TC-4	96	TC-H04	115	TCTMC	103
TC450	97	TC-H05	115	TC-UPRL	115
TC-4SBL	96	TC-LBK	115	TC-UPRLS	115
TC540	97	TC-LEG	115	TC-UPRR	115
TC-540W	97	TC-LOCK3	103	TC-UPRRS	115
TC803N	86	TC-LOCK5	103	TCW207N	92
TC803NBK	86	TC-MAG	102	TCW707EV	90
TC803SV	87	TC-MAT	98	TCW803N	87
TC805NFX	84	TCMM1001BK	22-23	TCW804N	88
TC805SV	85	TCMM1001N	20-21	TCW806LN	93
TC806NBK	83	TCMM1055N	24-25	TCW806N	88
TC806NF	83	TCMM277EV	47	TCW806N1	89
TC806NGM	83	TCMM479	30-31	TCW807N	89
TC806SV	84	TCMM491N	46	TCW808N	90
TC810N	85	TCMM545N	64-65	TCW809N	94
TC8140NF	54	TCMM546N	44-45	TCW810N	91
TC8140P	55	TCMM569EV	32-33	TCW810NBK	91
TC816STACK	80	TCMM600	28-29	TCW814N	93
TC816SV	81	TCMM622N	40-41	TCW816LN-STACK	82
TC819BK	80	TCMM715N	26-27	TCW819STACK	82
TC819NBK	80	TCMME09A	34-35	TCW907X	92
TC820SV	54	TCMME09B	56	TC-WC02	98
TC-90CLOCK	104	TCMME09C	51	TCW-CAB	95
TCA01	100	TCMME11A	50	TCW-CAB01	95
TCA05	98	TCMME174	53	TCW-CAB02	95
TCA06	469	TCMME179	52	TCW-CAB03	95
TCA06RK	469	TCMMIND08	42-43	TCW-HK02	101, 116
TCA07	469	TCMONSTER01	16-17	TCW-HK03	101, 116
TCATV	100	TCMONSTER02	18-19	TCW-HK10	101, 116
TCAV4	100	TCNBC	102	TCW-HK20	101, 116
TCB135	114	TCP445C	97	TCW-HK45	101, 116
TCB180	115	TC-PA01	115	TCW-HK90	101, 116
TCB80	114	TC-PA02	115	TCW-SP	100
TCB80A	114	TC-PA03	115	TCW-SP01	101
TCB80C	114	TCPRK	104	TDD03050	422
TC-BKEY	103	TCRFH	102	TDD04070	422
TCC01	115	TC-S01	113	TDD05080	422
TCC02	115	TC-S02	113	TDD06100	422
TCC03	115	TC-S03	116		

Item ID	Page No.	Item ID	Page No.	Item ID	Page No.
TDD08125	422	TEXPB4	184, 455	TORQ03A	281
TDD10150	422	TEXTB05	183, 439	TORQ03U	281
TDD12175	422	TEXW05	184, 445	TORQ04	281
TDT03050	422	TEZ01	162	TORQ04A	281
TDT04070	422	TF22	459	TORQ04U	281
TDT05080	422	TF2230RK	459	TORQ05	281
TDT06100	422	TF30	459	TORQ05A	281
TDT08125	422	TF300	460	TORQ05U	281
TDT10150	422	TF300RK	460	TORQ99A	281
TDT12175	422	TF76	459	TORQ99E	281
TEA01	162	TF76RK	459	TORQ99U	281
TEA02	162	TFA0252RK	460	TORQA	282
TEA1487	165, 198	TFA10	460	TORQS01	282
TEABS50	180, 347	TFA12	460	TORQU	282
TEAHR81	184, 464	TFA15	460	TPM01	117
TEAMDQ78	179, 356	TFA22	460	TPM02	117
TEASD38	171, 272	TFP01	459	TPT01	117
TED00	162	TFP01RK	460	TPX2501003	341
TED01	162	TFP02	460	TPX2501503	341
TED1227	166, 213	TFP02RK	460	TPX2502003	341
TED1489	165, 199	TGMMUNC	429	TPX2502503	341
TED3836	166, 206	THBS22	346	TPX2502703	341
TED441-T	181, 388	THBSI22	346	TPX2503003	341
TED6512R	174, 297	T-HD	235	TPX2504003	341
TED6512RS	174, 299	T-HD01	245, 439	TQAG	279
TED6515	173, 288	TJ1412	348	TQS018	280
TED8012	172, 293	TJ1413	348	TQS042	280
TED909TXN	176, 329	TJ1414	348	TQS055	280
TED911N	176, 329	TJ1415	194	TQS065	280
TED9121	170, 223	TJ1419	194	TR070	110
TEDADJ4	175, 315	TJ1420	194	TR135	110
TEDDF7	175, 307	TJ1429	347	TRC1012	439
TEDHEX7	180, 370	TJ1430	347	TRC1418	439
TEDHT42	180, 370	TJNS05	348	TT00	122
TEDIMM	183, 430	TM010	350	TT01	122
TEDPC14	184, 475	TM028	349	TT02	122
TEDSD14	172, 272, 359	TM029	349	TT03	122
TEDTX7	180, 373	TM035NF	62	TT04	122
TEDV440	183, 410	TM079	203	TT1205	128, 210
TEDV909N	183, 407	TM079E	203	TT1211	128, 210
TEFMB7	163	TM095	219	TT1215AF	129, 211
TEFMBP7	163	TM106	219	TT1217	128, 210
TEFMD54	178	TM111	220	TT1217-6	128, 210
TEFMDI54	179	TM127	220	TT1218	129, 211
TEFSK57	168	TM149	438	TT1218-6	129, 211
TEX02	162	TM708	320	TT1236	137, 287
TEX1238	172, 274	TMC010	350	TT1435	125, 198
TEX2032	173, 288	TMSE05S	452	TT143512	125, 198
TEX3403	167, 217	TMTX10	350	TT1448	126, 198
TEX3410	167, 217	TORP01A	282	TT3592	137, 287
TEX6308	175, 303	TORP01E	282	TT3816	127, 205
TEX915N	176, 329	TORP01U	282	TT381612	127, 205
TEXTXT13	166, 233	TORQ	282	TT3819	126, 204
TEFLS06	175, 303	TORQ02	281	TT381912	127, 204
TEXMB02	181, 388	TORQ02A	281	TT440	147, 386
TEXMDTN	179, 326	TORQ02U	281	TT440-T	147, 387
TEXMP12	172, 280	TORQ03	281	TT474-5	148, 394





Item ID	Page No.	Item ID	Page No.	Item ID	Page No.
TT474-7	148, 394	TTEPS15	163	TTSPG	150
TT474-7E	149, 394	TTEPS25	163	TTSTQ04	136, 187
TT6010M	137, 295	TTESK126	169	TTRORS	140, 309
TT6208	140, 305	TTESK32	167	TTRS15	131, 213
TT6506	140, 307	TTESK63	166	TTSD38	135, 272
TT6508R	138, 297	TTESK77	169	TTSN11	156, 454
TT6508RAF	138, 297	TTESK85	170	TTRS04	154, 437
TT6508RF	139, 300	TTESK86	168	TTSS07	154, 444
TT6508RS	139, 299	TTESP28	164	TTTC06	157, 461
TT6511R	138, 297	TTESP31	173	TTD17	152, 423
TT6511RS	139, 299	TTESP37	174	TTTF10	155, 442
TT8012	137, 293	TTEVG11	182	TTTHQ62	144, 354
TT804	155, 451	TTEX17	164	TTTJ04	123
TT9015HX	134, 223	TTEX23N	181	TTTM03	158, 466
TT9024	132, 221	TTEX32	174	TTTM08	158, 466
TT9116N	133, 221	TTHC03	154, 438	TTTS08	134, 222
TT9120DN	133, 222	TTHEX16	129, 211	TTTX18	130, 212
TT917N	141, 328	TTHEX23	130, 212	TTTX23	130, 212
TT917TXN	142, 328	TTHEX7	146, 369	TTTX30	127, 205
TT9207	133, 221	TTHEX7AF	146, 369	TTTX7	146, 373
TT9207A	133, 221	TTHEX7S	146, 369	TTTXH15	130, 212
TT9212	133, 222	TTHP08	141, 311	TTV440	151, 410
TT9212TX	134, 222	TTHR81	157, 464	TTV706N	150, 407
TTADJ04	141, 315	TTHT28	147, 370	TTV710N	151, 406
TTADP17	132, 234	TTID19	135, 358	TTV907N	150, 407
TTAF32	126, 204	TTID20	135, 359	TTVG05	149, 397
TTAF3212	126, 204	TTK40	151, 420	TTX00	123
TTALU	122	TTMD12D	142, 325	TTX01	123
TTBE18	156, 454	TTMD74	145, 355	TTX02	124
TTBM	153, 430	TTMD74-1	344	TTX03	124
TTBS35	128, 205	TTMD74-2	344	TTX1292	136, 275
TTBS53	145, 347	TTMDP	153, 437	TTX2032	138, 287
TTCP04	157, 457	TTMDQ38	144, 354	TTX2640	138, 288
TTCP121	156, 457	TTMDQ49	143, 354	TTX3402E	131, 217
TTD00	123	TTMDQ76	144, 355	TTX3404	131, 216
TTD01	123	TTMDR84	144, 355	TTX3404S	131, 217
TTD02	123	TTMDRT64	145, 354	TTX3414	132, 217
TTD441	147, 387	TTMI16	143, 319, 390	TTX34AF	132, 217
TTD441-T	148, 387	TTNF12	152, 425	TTX3892	136, 274
TTD912TXN	142, 328	TTNF12-01	424	TTX474-9	149, 394
TTD914N	141, 328	TTNF12-02	424	TTX6311	139, 302
TTD9416	134, 223	TTNF12-03	424	TTX6607	140, 305
TTDAWM13M	159, 485	TTNF12-04	424	TTX6707	139, 302
TTDB28	152, 421	TTNF12-05	424	TTX918N	142, 329
TTDCM	153, 430	TTNF12-06	424	TTX9415	135, 223
TTDCT05	151, 416	TTNF12-07	424	TTXEXT13	131, 233
TTDTD34	152, 423	TTNF12-08	424	TTXF05	153, 426
TTDV910N	150, 407	TTNF12-09	424	TTXFLS06	139, 302
TTEAF62	173	TTNF12-10	424	TTXLMP12	138, 295
TTEISK33	171	TTNF12-11	424	TTXMB02	148, 387
TTEISK73	171	TTNF12-12	424	TTXMD41N	145, 355
TTEMB11	181	TTNR81	157, 464	TTXMDTN	143, 326
TTEMB17	182	TTOS16	154, 441	TTXMP12	137, 280
TTEMD122N	177	TTPC09	158, 475	TTXND	143, 327
TTEMD33	178	TTPS09	124	TTXP1292	136, 276
TTEMD98N	177	TTPS09E	124	TTXPB3	156, 455
TTEPS12	164	TTPSAD	155, 447	TTXPB3A	156, 455

Item ID	Page No.	Item ID	Page No.
TTXQRS07	140, 310	TXP3002505	340
TTXTB05	155, 439	TXP3002701	340
TTXTB09	155, 245	TXP3002705	340
TTZ01	124	TXP3003001	340
TTZVG03	149, 397	TXP3003005	340
TV18N	411	TXP3004001	340
TW1160	391	TXP3004005	340
TW1180	391	TXP5001001	340
TW2125	391	TXP5001501	340
TW2160	391	TXP5002001	340
TW2180	391	TXP5002501	340
TWB1500	112	TXP5002701	340
TWB-1500A	112	TXP5003001	340
TWB-15SQ	112	TXP5004001	340
TWB-15TOP	112	TXP8902001	340
TWB2000	112	TXP8902501	340
TWB-2000A	112	TXP8903001	340
TWB-20SQ	115	TXX1015	325
TWB-20TOP	112	TXX2025	325
TWB-4WD	112	TXX3040	325
TWB-FB	115	TXX32101505	339
TWB-LEG	112	TXX32202505	339
TWB-PA	112	WCC06	476
TWB-UPR	112	WCC08	476
TX2500603	339	WCC10	476
TX2500703	339	WCC12	476
TX2500803	339	WCC14	476
TX2500903	339	WCC16	476
TX2501003	339	WCC18	476
TX2501503	339	WCC20	476
TX2502003	339	WCC22	476
TX2502503	339	WCC25	476
TX2502703	339	WCC32	476
TX2503003	339	WCC38	476
TX2504003	339	WCS04L	477
TX5000803	339	WCS04S	477
TX5001003	339	WR8012	187, 294
TX5001503	339	WRDF06	188, 307
TX5002003	339	WRFL05	191, 426
TX5002503	339	WRFLS05	188, 303
TX5002703	339	WRHEX07	189, 370
TX5003003	339	WRHEX07AF	189, 371
TX7001002	340	WRMB04	190, 388
TX7001502	340	WRMBV04	190, 411
TX7002002	340	WRMD10N	188, 330
TX7002502	340	WRMDT05N	189, 327
TX8901001	340	WRMDV05N	190, 408
TX8902001	340	WRMDV07N	190, 408
TX8902501	340	WRPC10	191, 476
TX8903001	340	WRSP12	187, 288
TXP3001001	340	WRSP12LMP	187, 295
TXP3001005	340	WRSP12RS	188, 299
TXP3001501	340	WRTX07	189, 374
TXP3001505	340	WRWC07	191, 477
TXP3002001	340		
TXP3002005	340		
TXP3002501	340		



**TENGTOLLS®**

**Teng Tools AB**  
Sandbergsvägen 3D  
441 39 Alingsås  
Sweden  
✉ hello@tengtools.com  
☎ +46 322 60 66 00